



Operation **Manual**

Goodrive 35 Series **Close Loop Vector Control Inverter**



SHENZHEN INVT ELECTRIC CO., LTD.

Preface

Thanks for choosing our products.

Goodrive35 series inverters are high performance open loop vector inverters for controlling asynchronous AC induction motors and permanent magnet synchronous motors. Applying the most advanced non-velocity sensor vector control technology which keeps pace with the leading international technology and DSP control system, our products enhances its reliability to meet the adaptability to the environment, customized and industrialized design with more optimized functions, more flexible application and more stable performance.

The control performance of Goodrive35 series inverters is as outstanding as that of the leading sophisticated inverters on worldwide market. Goodrive35 series inverters integrate the drive of asynchronous motors and synchronous motors, torque control and speed control, meeting the high performance requirement of the customer applications and stepping on the unique incorporated inverters with superexcellent control functions in this circle. Simultaneously, comparing with the other kinds, Goodrive35 series inverters can adapt to worse grid, temperature, humidity and dust with a better performance of anti-tripping and improved the reliability.

Goodrive35 series inverters apply modularized design to meet the specific demand of customers, as well as the demand of the whole industry flexibly and follow the trend of industrial application to the inverters on the premise of meeting general need of the market. Powerful speed control, torque control, simple PLC, flexible input/output terminals, pulse frequency given, traverse control can realize various complicate high-accuracy drives and provide integrative solution for the manufacturers of industrial devices, which contributes a lot to the cost reducing and improves reliability.

Goodrive35 series inverters can meet the demand of environmental protection which focuses on low noise and weakening electromagnetic interference in the application sites for the customers.

This manual provides installation and configuration, parameters setting, fault diagnoses and daily maintenance and relative precautions to customers. Please read this manual carefully before the installation to ensure a proper installation and operation and high performance of Goodrive35 series inverters.

If the product is ultimately used for military affairs or manufacture of weapon, it will be listed on the export control formulated by ***Foreign Trade Law of the People's Republic of China***. Rigorous review and necessary export formalities are needed when exported.

Our company reserves the right to update the information of our products.

Content

Preface.....		1
Content		2
Safety Precautions	1	5
1.1 What this chapter contains.....		5
1.2 Safety definition.....		5
1.3 Warning symbols.....		5
1.4 Safety guidelines.....		6
Quick Start-up	2	10
2.1 What this chapter contains.....		10
2.2 Unpacking inspection.....		10
2.3 Application confirmation.....		10
2.4 Environment.....		11
2.5 Installation confirmation.....		11
2.6 Basic commission.....		12
Product Overview	3	13
3.1 What this chapter contains.....		13
3.2 Basic principles.....		13
3.3 Product specification.....		14
3.4 Name plate.....		17
3.5 Type designation key.....		17
3.6 Rated specifications.....		19
3.7 I/O PG card selection.....		21
3.8 Structure diagram.....		21
Installation guidelines	4	23
4.1 What this chapter contains.....		23
4.2 Mechanical installation.....		23
4.3 Standard wiring.....		29
4.4 Standard wiring (control circuit).....		35
4.5 Layout protection.....		45
Keypad operation procedure	5	47
5.1 What this chapter contains.....		47
5.2 Keypad.....		47
5.3 Keypad displaying.....		50
5.4 Keypad operation.....		51

Function parameters	6	54
6.1 What this chapter contains		54
6.2 Goodrive35 general series function parameters		54
Basic operation instruction	7	170
7.1 What this chapter contains		170
7.2 First powering on		170
7.3 Vector control		175
7.4 SVPWM control		180
7.5 Torque control		187
7.6 Parameters of the motor		190
7.7 Start-up and stop control		196
7.8 Frequency setting		201
7.9 Analog input		206
7.10 Analog output		209
7.11 Digital input		212
7.12 Digital input		222
7.13 Simple PLC		228
7.14 Multi-step speed running		230
7.15 PID control		232
7.16 Commissioning for special functions		238
7.17 Fault solutions		245
Fault tracking	8	250
8.1 What this chapter contains		250
8.2 Alarm and fault indications		250
8.3 How to reset		250
8.4 Fault history		250
8.5 Fault instruction and solution		250
8.6 Common fault analysis		256
Maintenance and hardware diagnostics	9	263
9.1 What this chapter contains		263
9.2 Maintenance intervals		263
9.3 Cooling fan		266
9.4 Capacitors		267
9.5 Power cable		268
Communication protocol	10	269
10.1 What this chapter contains		269

Goodrive35 inverters	Content
10.2 Brief instruction to Modbus protocol	269
10.3 Application of the inverter	270
10.4 RTU command code and communication data illustration	276
10.5 Common communication fault.....	289
Extension card	Appendix A
A.1 What this chapter contains	291
A.2 PROFIBUS/CANOPEN extension card.....	291
A.3 CANOpen optional cards.....	309
Technical data	Appendix B
B.1 What this chapter contains	310
B.2 Ratings	310
B.3 Grid specifications.....	311
B.4 Motor connection data.....	312
B.5 Applicable standards.....	312
B.6 EMC regulations	313
Dimension drawings	Appendix C
C.1 What this chapter contains	315
C.2 Keypad structure.....	315
C.3 Inverter structure.....	316
C.4 Dimensions for inverters of AC 3PH 380V(-15%)~440V(+10%)	316
C.5 Dimensions for inverters of AC 3PH 520V(-15%)~690V(+10%)	321
Peripheral options and parts	Appendix D
D.1 What this chapter contains	324
D.2 Peripheral wiring	324
D.3 Power supply	325
D.4 Cables	326
D.5 Breaker and electromagnetic contactor	331
D.6 Reactors	333
D.7 Filter	336
D.8 Braking system	338
Further information	Appendix E
	344

Safety Precautions

1

1.1 What this chapter contains

Please read this manual carefully and follow all safety precautions before moving, installing, operating and servicing the inverter. If ignored, physical injury or death may occur, or damage may occur to the devices.





If any physical injury or death or damage to the devices occurs for ignoring to the safety precautions in the manual, our company will not be responsible for any damages and we are not legally bound in any manner.





1.2 Safety definition

- Danger:** Serious physical injury or even death may occur if not follow relevant requirements
- Warning:** Physical injury or damage to the devices may occur if not follow relevant requirements
- Note:** Physical hurt may occur if not follow relevant requirements
- Qualified electricians:** People working on the device should take part in professional electrical and safety training, receive the certification and be familiar with all steps and requirements of installing, commissioning, operating and maintaining the device to avoid any emergency.





1.3 Warning symbols

Warnings caution you about conditions which can result in serious injury or death and/or damage to the equipment, and advice on how to avoid the danger. Following warning symbols are used in this manual:

Symbols	Name	Instruction	Abbreviation
 Danger	Electrical Danger	Serious physical injury or even death may occur if not follow the relative requirements	
 Warning	General danger	Physical injury or damage to the devices may occur if not follow the relative requirements	

Symbols	Name	Instruction	Abbreviation
 Do not	Electrostatic discharge	Damage to the PCBA board may occur if not follow the relative requirements	
 Hot sides	Hot sides	Sides of the device may become hot. Do not touch.	
Note	Note	Physical hurt may occur if not follow the relative requirements	Note

1.4 Safety guidelines

	<p>↯ Only qualified electricians are allowed to operate on the inverter.</p> <p>↯ Do not carry out any wiring and inspection or changing components when the power supply is applied. Ensure all input power supply is disconnected before wiring and checking and always wait for at least the time designated on the inverter or until the DC bus voltage is less than 36V. Below is the table of the waiting time:</p>																					
	<table border="1"> <thead> <tr> <th colspan="2">Inverter module</th> <th>Minimum waiting time</th> </tr> </thead> <tbody> <tr> <td>380V</td> <td>1.5kW-110kW</td> <td>5 minutes</td> </tr> <tr> <td>380V</td> <td>132 kW -315 kW</td> <td>15 minutes</td> </tr> <tr> <td>380V</td> <td>above 350 kW</td> <td>25 minutes</td> </tr> <tr> <td>660V</td> <td>22kW-132kW</td> <td>5 minutes</td> </tr> <tr> <td>660V</td> <td>160kW-350kW</td> <td>15 minutes</td> </tr> <tr> <td>660V</td> <td>400kW-630kW</td> <td>25 minutes</td> </tr> </tbody> </table>	Inverter module		Minimum waiting time	380V	1.5kW-110kW	5 minutes	380V	132 kW -315 kW	15 minutes	380V	above 350 kW	25 minutes	660V	22kW-132kW	5 minutes	660V	160kW-350kW	15 minutes	660V	400kW-630kW	25 minutes
	Inverter module		Minimum waiting time																			
	380V	1.5kW-110kW	5 minutes																			
	380V	132 kW -315 kW	15 minutes																			
	380V	above 350 kW	25 minutes																			
	660V	22kW-132kW	5 minutes																			
660V	160kW-350kW	15 minutes																				
660V	400kW-630kW	25 minutes																				
<p> ↯ Do not refit the inverter unauthorizdly; otherwise fire, electric shock or other injury may occur.</p>																						
<p> ↯ The base of the radiator may become hot during running. Do not touch to avoid hurt.</p>																						
<p> ↯ The electrical parts and components inside the inverter are electrostatic. Take measurements to avoid electrostatic discharge during relevant operation.</p>																						

1.4.1 Delivery and installation

	<p>↯ Please install the inverter on fire-retardant material and keep the inverter away from combustibile materials.</p>
---	---

	<ul style="list-style-type: none"> ⇨ Connect the braking optional parts (braking resistors, braking units or feedback units) according to the wiring diagram. ⇨ Do not operate on the inverter if there is any damage or components loss to the inverter. ⇨ Do not touch the inverter with wet items or body, otherwise electric shock may occur.
---	--

Note:

- ⇨ Select appropriate moving and installing tools to ensure a safe and normal running of the inverter and avoid physical injury or death. For physical safety, the erector should take some mechanical protective measurements, such as wearing exposure shoes and working uniforms.
- ⇨ Ensure to avoid physical shock or vibration during delivery and installation.
- ⇨ Do not carry the inverter by its cover. The cover may fall off.
- ⇨ Install away from children and other public places.
- ⇨ The inverter cannot meet the requirements of low voltage protection in IEC61800-5-1 if the sea level of installation site is above 2000m.
- ⇨ Please use the inverter on appropriate condition (See chapter *Installation Environment*).
- ⇨ Don't allow screws, cables and other conductive items to fall inside the inverter.
- ⇨ The leakage current of the inverter may be above 3.5mA during operation. High leakage current, earth connection essential before connecting supply. Ground with proper techniques and ensure the grounding resistor is less than 10Ω. The conductivity of PE grounding conductor is the same as that of the phase conductor (with the same cross sectional area).
- ⇨ R, S and T are the input terminals of the power supply, while U, V and W are the motor terminals. Please connect the input power cables and motor cables with proper techniques; otherwise the damage to the inverter may occur.

1.4.2 Commission and running

	<ul style="list-style-type: none"> ⇨ Disconnect all power supplies applied to the inverter before the terminal wiring and wait for at least the designated time after disconnecting the power supply. ⇨ High voltage is present inside the inverter during running. Do not carry out any operation except for the keypad setting.
---	---

	<ul style="list-style-type: none"> ✧ The inverter may start up by itself when P01.21=1. Do not get close to the inverter and motor. ✧ The inverter can not be used as “Emergency-stop device”. ✧ The inverter can not be used to break the motor suddenly. A mechanical braking device should be provided. ✧ Besides the above items, check to ensure the following ones before the installation and maintenance during the running of the permanent synchronization motor: <ol style="list-style-type: none"> 1. All input power supply is disconnected (including the main power supply and the control power supply). 2. The permanent magnet synchronization motor has stopped running and measured to ensure the output voltage of the inverter is less than 36V. 3. The waiting time of the permanent magnet synchronization motor after stopping is no less than the time designated and measure to ensure the voltage between + and – is less than 36V. 4. Ensure the permanent magnet synchronization motor does not rotate again because of the external load. It is recommended to install effectively external braking devices or disconnect the electric wiring between the motor and the inverter directly.
---	--

Note:

- ✧ Do not switch on or off the input power supply of the inverter frequently.
- ✧ For inverters that have been stored for a long time, check and fix the capacitance and try to run it again before utilization (see ***Maintenance and Hardware Fault Diagnose***).
- ✧ Cover the front board before running, otherwise electric shock may occur.

1.4.3 Maintenance and replacement of components

	<ul style="list-style-type: none"> ✧ Only qualified electricians are allowed to perform the maintenance, inspection, and components replacement of the inverter. ✧ Disconnect all power supplies to the inverter before the terminal wiring. Wait for at least the time designated on the inverter after disconnection. ✧ Take measures to avoid screws, cables and other conductive matters to fall into the inverter during maintenance and component replacement.
---	---

Note:

- ✧ Please select proper torque to tighten screws.
- ✧ Keep the inverter, parts and components away from combustible materials during maintenance and component replacement.
- ✧ Do not carry out any isolation and pressure test on the inverter and do not measure the control circuit of the inverter by megameter.
- ✧ Carry out a sound anti-electrostatic protection to the inverter and its internal components during maintenance and component replacement.

1.4.4 What to do after scrapping

- ✧ There are heavy metals in the inverter. Deal with it as industrial effluent.

Quick Start-up

2

2.1 What this chapter contains

This chapter mainly describes the basic guidelines during the installation and commissioning procedures on the inverter, which you may follow to install and commission the inverter quickly.

2.2 Unpacking inspection

Check as followings after receiving products:

1. Check that there are no damage and humidification to the package. If not, please contact with local agents or company offices.
2. Check the information on the type designation label on the outside of the package to verify that the drive is of the correct type. If not, please contact with local dealers or company offices.
3. Check that there are no signs of water in the package and no signs of damage or breach to the inverter. If not, please contact with local dealers or company offices.
4. Check the information on the type designation label on the outside of the package to verify that the name plate is of the correct type. If not, please contact with local dealers or company offices.
5. Check to ensure the accessories (including user's manual, control keypad and extension card) inside the device is complete. If not, please contact with local dealers or company offices.

2.3 Application confirmation

Check the machine before beginning to use the inverter:

1. Check the load type to verify that there is no overload of the inverter during work and check that whether the drive needs to modify the power degree.
2. Check that the actual current of the motor is less than the rated current of the inverter.
3. Check that the control accuracy of the load is the same of the inverter.
4. Check that the incoming supply voltage is correspondent to the rated voltage of the inverter.
5. Check that the communication needs option card or not.

2.4 Environment

Check as followings before the actual installation and usage:

1. Check that the ambient temperature of the inverter is below 40°C. If exceeds, derate 3% for every additional 1°C. Additionally, the inverter can not be used if the ambient temperature is above 50°C.

Note: for the cabinet inverter, the ambient temperature means the air temperature inside the cabinet.

2. Check that the ambient temperature of the inverter in actual usage is above -10°C. If not, add heating facilities.

Note: for the cabinet inverter, the ambient temperature means the air temperature inside the cabinet.

3. Check that the altitude of the actual usage site is below 1000m. If exceeds, derate 1% for every additional 100m.

4. Check that the humidity of the actual usage site is below 90% and condensation is not allowed. If not, add additional protection inverters.

5. Check that the actual usage site is away from direct sunlight and foreign objects can not enter the inverter. If not, add additional protective measures.

6. Check that there is no conductive dust or flammable gas in the actual usage site. If not, add additional protection to inverters.

2.5 Installation confirmation

Check as followings after the installation:

1. Check that the load range of the input and output cables meet the need of actual load.

2. Check that the accessories of the inverter are correctly and properly installed. The installation cables should meet the needs of every component (including reactors, input filters, output reactors, output filters, DC reactors, braking units and braking resistors).

3. Check that the inverter is installed on non-flammable materials and the calorific accessories (reactors and brake resistors) are away from flammable materials.

4. Check that all control cables and power cables are run separately and the routation complies with EMC requirement.

5. Check that all grounding systems are properly grounded according to the requirements of the inverter.

6. Check that the free space during installation is sufficient according to the instructions in user's manual.

- | |
|---|
| 7. Check that the installation conforms to the instructions in user's manual. The drive must be installed in an upright position. |
| 8. Check that the external connection terminals are tightly fastened and the torque is appropriate. |
| 9. Check that there are no screws, cables and other conductive items left in the inverter. If not, get them out. |

2.6 Basic commission

Complete the basic commissioning as followings before actual utilization:

- | |
|---|
| 1. Select the motor type, set correct motor parameters and select control mode of the inverter according to the actual motor parameters. |
| 2. Autotune. If possible, de-coupled from the motor load to start dynamic autotune. Or if not, static autotune is available. |
| 3. Adjust the ACC/DEC time according to the actual running of the load. |
| 4. Commission the device via jogging and check that the rotation direction is as required. If not, change the rotation direction by changing the wiring of motor. |
| 5. Set all control parameters and then operate. |

Product Overview

3

3.1 What this chapter contains

The chapter briefly describes the operation principle, product characteristics, layout, name plate and type designation information.

3.2 Basic principles

Goodrive35 series inverters are wall, floor and flange mountable devices for controlling asynchronous AC induction motors and permanent magnet synchronous motors.

The diagram below shows the simplified main circuit diagram of the inverter. The rectifier converts three-phase AC voltage to DC voltage. The capacitor bank of the intermediate circuit stabilizes the DC voltage. The converter transforms the DC voltage back to AC voltage for the AC motor. The brake pipe connects the external braking resistor to the intermediate DC circuit to consume the feedback energy when the voltage in the circuit exceeds its maximum limit.

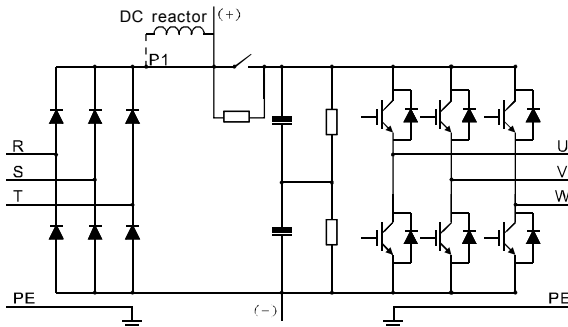

Fig 3-1 The simplified main circuit diagram (inverters of 380V≥37kW)

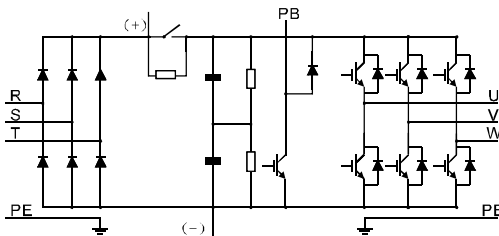
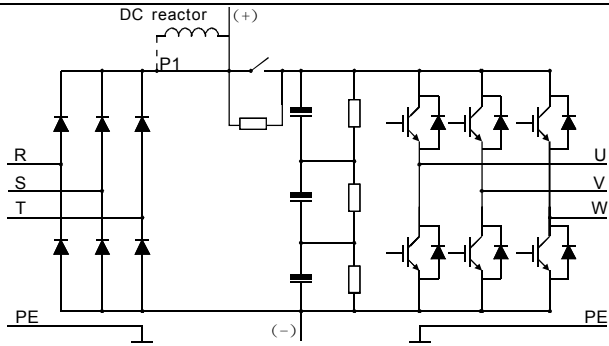

Fig 3-2 The simplified main circuit diagram (inverters of 380V≤30kW)



Note: Fig 3-3 The simplified main circuit diagram (inverters of 660V)

1. The inverters of 380V($\geq 37\text{kW}$) supports external DC reactors and external braking units, but it is necessary to remove the copper tag between P1 and(+) before connecting. DC reactors and external braking units are optional.
2. The inverters of 380V ($\leq 30\text{kW}$) supports external braking resistors which are optional.
3. The inverters of 660V supports external DC reactors and external braking units, but it is necessary to remove the copper tag between P1 and (+) before connecting. DC reactors and external braking units are optional.

3.3 Product specification

Function		Specification
Power input	Input voltage (V)	AC 3PH 380V(-15%)~440V(+10%) Rated voltage:380V AC 3PH 520V(-15%)~690V(+10%) Rated voltage:660V
	Input current (A)	Refer to <i>the rated value</i>
	Input frequency (Hz)	50Hz or 60Hz Allowed range: 47~63Hz
Power output	Output voltage (V)	0~input voltage
	Output current (A)	Refer to <i>the rated value</i>
	Output power (kW)	Refer to <i>the rated value</i>
	Output frequency (Hz)	0~400Hz
Technical control	Control mode	SVPWM, sensorless vector control
	Motor type	Asynchronous motor and permanent magnet

Function		Specification
feature		synchronous motor
	Adjustable-speed ratio	Asynchronous motor 1:200 (SVC) synchronous motor 1:20 (SVC)
	Speed control accuracy	±0.2% (sensorless vector control)
	Speed fluctuation	± 0.3%(sensorless vector control)
	Torque response	<20ms(sensorless vector control)
	Torque control accuracy	10%(sensorless vector control)
	Starting torque	Asynchronous motor: 0.25Hz/150%(sensorless vector control) Synchronous motor: 2.5 Hz/150%(sensorless vector control)
	Overload capability	150% of rated current: 1 minute 180% of rated current: 10 seconds 200% of rated current: 1 second
Running control feature	Frequency setting method	Digital setting, analog setting, pulse frequency setting, multi-step speed running setting, simple PLC setting, PID setting, MODBUS communication setting, PROFIBUS communication setting. Switch between the combination and single setting channel.
	Auto-adjustment of the voltage	Keep constant voltage automatically when the grid voltage transients
	Fault protection	Provide more than 30 fault protection functions: overcurrent, overvoltage, undervoltage, overheating, phase loss and overload, etc.
	Restart after rotating speed tracking	Smooth starting of the rotating motor Note: Only for the inverter≥4kW
Peripheral interface	Terminal analog input resolution	≤ 20mV
	Terminal switch input	≤ 2ms

Function		Specification
	resolution	
	Analog input	2 (AI1, AI2) 0~10V/0~20mA and 1 (AI3) -10~10V
	Analog output	2 (AO1, AO2) 0~10V /0~20mA
	Digital input	8 common inputs, the Max. frequency: 1kHz, internal impedance: 3.3kΩ; 1 high speed input, the Max. frequency: 50kHz
	Digital output	1 high speed pulse output, the Max. frequency: 50kHz; 1 Y terminal open collector output
	Relay output	2 programmable relay outputs RO1A NO, RO1B NC, RO1C common terminal RO2A NO, RO2B NC, RO2C common terminal Contactor capability: 3A/AC250V,1A/DC30V
Special functions	Speed control range	1:1000
	Speed accuracy	±0.02%
	Response time	<10ms
	Torque control accuracy	5%
	Start frequency/ Start torque	0Hz/200%
	Reference mode	Analog 0~10V/0~20mA, -10V~+10V, pulse train, communication reference and MS speed
	Spindle stopping	For spindle positioning and control sequence Internal 7 scale marks and 4 zero marks
	Position reference	External zero-position detection switch positioning Encoder Z phase positioning
	Servo control	Pulse train reference: position control
	Frequency division output	Encoder frequency division output (H1 inverters)
	Speed/position mode	Terminal shifting
Encoder	A1 support 200kHz, B1 and C1 support 100kHz, D1 support 500kHz, H1 support 300kHz	

Function		Specification
	Positioning	Z pulse and photoelectric switch positioning
Others	Mountable method	Wall, flange and floor mountable
	Temperature of the running environment	-10~50℃, derate above 40℃
	Average non-fault time	2 years (25℃ ambient temperature)
	Protective degree	IP20
	Cooling	Air-cooling
	Braking unit	Built-in for inverters of 380V(≤30kW) External for others
	EMC filter	Built-in C3 filter for 380V inverters: meet the degree requirement of IEC61800-3 C3 No built-in filters for 660V inverters External filter:optional, meet the degree requirement of IEC61800-3 C2

3.4 Name plate

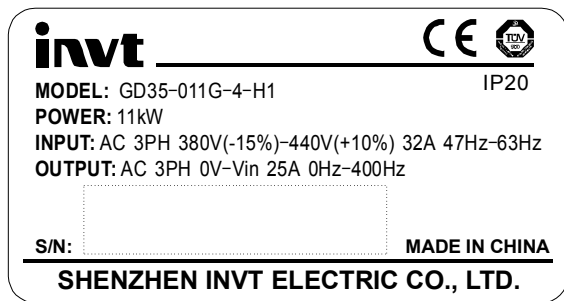

Fig 3-4 Name plate

Note: After the CE certification, the icon can be marked.

3.5 Type designation key

The type designation contains information on the inverter. The user can find the type designation on the type designation label attached to the inverter or the simple name plate.

3.5.1 Model

GD35 - 5R5G - 4 - H1

①

②

③

④

Key	Sign	Instruction	Content
Abbreviation	①	Abbreviation	Goodrive35: Goodrive35 close-loop vector control inverters
Rated power	②	Power + Load	5R5-5.5kW G—constant torque load
Voltage degree	③	Voltage degree	4:AC 3PH 380V(-15%)~440V(+10%) Rated voltage:380V 6:AC 3PH 520V(-15%)~690V(+10%) Rated voltage:660V
Lot number	④	Lot number	A1: support 5V differential incremental encoder B1: support 12V incremental encoder C1: support 24V incremental encoder D1: support rotary transformer Optional PG cards with functions of pulse and direction pulse input reference H1: support 5V/12V incremental encoder, Pulse + direction pulse input reference

3.5.2 I/O PG card

EC-PG 3 01 - 24

①

②

③

④

⑤

No.	Instruction	Content
①	Product type	EC-Extension card
②	Card type	PG: P/G card
③	Technical version	Odds(1,3,5) are used to shown the technical version(the first generation, second generation and third generation) Note: 3 means special for GD3XX series products.
④	Code	01: PG port of incremental encoder
		02: PG port of sine/cosine encoder
		03: PG port of UVW encoder
		04: PG port of rotary transformer(standard)+pulse direction reference(optional)

No.	Instruction	Content
		05: PG port of incremental encoder + pulse direction reference
⑤	Power supply	00:Null
		05:5V
		12:12~15V
		24:24V

3.6 Rated specifications

3.6.1 The inverters of AC 3PH 380V(-15%)~440V(+10%)

Model	Rated output power(kW)	Rated input current(A)	Rated output current(A)	Model
GD35-1R5G-4-C1/D1/H1	1.5	5.0	3.7	1~15(8)
GD35-2R2G-4-C1/D1/H1	2.2	5.8	5	1~15(8)
GD35-004G-4-A1/B1/C1/D1/H1	4	13.5	9.5	1~15(8)
GD35-5R5G-4- A1/B1/C1/D1/H1	5.5	19.5	14	1~15(8)
GD35-7R5G-4- A1/B1/C1/D1/H1	7.5	25	18.5	1~15(8)
GD35-011G-4- A1/B1/C1/D1/H1	11	32	25	1~15(8)
GD35-015G-4- A1/B1/C1/D1/H1	15	40	32	1~15(4)
GD35-018G-4- C1/D1/H1	18.5	47	38	1~15(4)
GD35-022G-4- C1/D1/H1	22	56	45	1~15(4)
GD35-030G-4-C1/D1/H1	30	70	60	1~15(4)
GD35-037G-4-C1/D1/H1	37	80	75	1~15(4)
GD35-045G-4-C1/D1/H1	45	94	92	1~15(4)
GD35-055G-4-C1/D1/H1	55	128	115	1~15(4)
GD35-075G-4-C1/D1/H1	75	160	150	1~15(2)
GD35-090G-4-C1/D1/H1	90	190	180	1~15(2)
GD35-110G-4-C1/D1/H1	110	225	215	1~15(2)
GD35-132G-4-C1/D1/H1	132	265	260	1~15(2)
GD35-160G-4-C1/D1/H1	160	310	305	1~15(2)
GD35-200G-4-C1/D1/H1	200	385	380	1~15(2)
GD35-220G-4-C1/D1/H1	220	430	425	1~15(2)
GD35-250G-4-C1/D1/H1	250	460	480	1~15(2)

Model	Rated output power(kW)	Rated input current(A)	Rated output current(A)	Model
GD35-280G-4-C1/D1/H1	280	500	530	1~15(2)
GD35-315G-4-C1/D1/H1	315	580	600	1~15(2)

Note:

1. The input current of inverters 1.5~315kW is detected when the input voltage is 380V and there is no DC reactors and input/output reactors.
2. The rated output current is defined when the output voltage is 380V.
3. The output current can not exceed the rated output current and the output power can not exceed the rated output power in the voltage range.

3.6.2 The inverters of AC 3PH 520V(-15%)~690V(+10%)

Model	Rated output power(kW)	Rated input current(A)	Rated output current(A)	Carrier frequency (kHz)
GD35-022G-6-C1/D1/H1	22	35	27	1~15(4)
GD35-030G-6-C1/D1/H1	30	40	34	1~15(4)
GD35-037G-6-C1/D1/H1	37	47	42	1~15(4)
GD35-045G-6-C1/D1/H1	45	52	54	1~15(4)
GD35-055G-6-C1/D1/H1	55	65	62	1~15(4)
GD35-075G-6-C1/D1/H1	75	85	86	1~15(2)
GD35-090G-6-C1/D1/H1	90	95	95	1~15(2)
GD35-110G-6-C1/D1/H1	110	118	131	1~15(2)
GD35-132G-6-C1/D1/H1	132	145	147	1~15(2)
GD35-160G-6-C1/D1/H1	160	165	163	1~15(2)
GD35-185G-6-C1/D1/H1	185	190	198	1~15(2)
GD35-200G-6-C1/D1/H1	200	210	216	1~15(2)
GD35-220G-6-C1/D1/H1	220	230	240	1~15(2)
GD35-250G-6-C1/D1/H1	250	255	274	1~15(2)
GD35-280G-6-C1/D1/H1	280	286	300	1~15(2)
GD35-315G-6-C1/D1/H1	315	334	328	1~15(2)
GD35-350G-6-C1/D1/H1	350	360	380	1~15(2)
GD35-400G-6-C1/D1/H1	400	411	426	1~15(2)

Model	Rated output power(kW)	Rated input current(A)	Rated output current(A)	Carrier frequency (kHz)
GD35-500G-6-C1/D1/H1	500	518	540	1~15(2)
GD35-560G-6-C1/D1/H1	560	578	600	1~15(2)
GD35-630G-6-C1/D1/H1	630	655	680	1~15(2)

Note:

1. The input current of inverters 22~350kW is detected when the input voltage is 660V and there is no DC reactors and input/output reactors.
2. The input current of inverters 400~630kW is detected when the input voltage is 660V and there are input reactors.
3. The rated output current is defined when the output voltage is 660V.
4. The output current can not exceed the rated output current and the output power can not exceed the rated output power in the voltage range.

3.7 I/O PG card selection

Model	Instruction	Specification
EC-PG301-05	5V I/O incremental PG card	5V incremental ABZ encoder, support differential input Max. 200kHz
EC-PG301-12	12V I/O incremental PG card	12V incremental ABZ encoder, support differential, OC and push-pull input, Max. 100kHz
EC-PG301-24	24V I/O incremental PG card	24V incremental ABZ encoder, support differential, OC and push-pull input, Max. 100kHz
EC-PG304-05	5V I/O rotary transformer PG card	Rotary transformer encoder, Max. 500kHz
EC-PG305-12	5V/12V I/O multi-function incremental PG card	5V/12V incremental ABZ encoder, support pulse/direction differential input and frequency-division output, Max. 300kHz
EC-PG304-00	I/O rotary transformer PG card	Rotary transformer encoder, support pulse/direction differential input and 5V differential frequency-division output(optional for D1), Max. 500kHz

3.8 Structure diagram

Below is the layout figure of the inverter (take the inverter of 380V 30kW as the example).

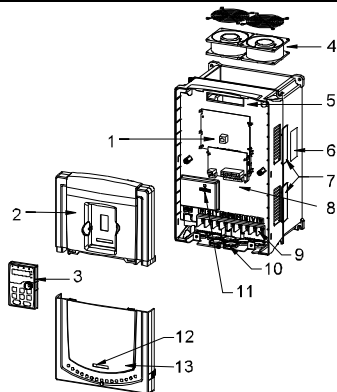

Fig 3-6 Product structure

Serial No.	Name	Illustration
1	Keypad port	Connect the keypad
2	Upper cover	Protect the internal parts and components
3	Keypad	See <i>Keypad Operation Procedure</i> for detailed information
4	Cooling fan	See <i>Maintenance and Hardware Fault Diagnose</i> for detailed information
5	Wiring port	Connect to the control board and the drive board
6	Name plate	See <i>Product Overview</i> for detailed information
7	Side cover	Optional. The side cover will increase the protective degree of the inverter. The internal temperature of the inverter will increase, too, so it is necessary to derate the inverter at the same time
8	Control terminals	See <i>Electric Installation</i> for detailed information
9	Main circuit terminals	See <i>Electric Installation</i> for detailed information
10	Main circuit cable port	Fix the main circuit cable
11	POWER light	Power indicator
12	Simple name plate	See <i>Model codes</i> for detailed information
13	Lower cover	Protect the internal parts and components

Installation guidelines

4

4.1 What this chapter contains

The chapter describes the mechanical installation and electric installation.

	<ul style="list-style-type: none"> ↪ Only qualified electricians are allowed to carry out what described in this chapter. Please operate as the instructions in Safety Precautions. Ignoring these may cause physical injury or death or damage to the devices. ↪ Ensure the power supply of the inverter is disconnected during the operation. Wait for at least the time designated until the POWER indicator is off after the disconnection if the power supply is applied. It is recommended to use the multimeter to monitor that the DC bus voltage of the drive is under 36V. ↪ The installation and design of the inverter should be complied with the requirement of the local laws and regulations in the installation site. If the installation infringes the requirement, our company will exempt from any responsibility. Additionally, if users do not comply with the suggestion, some damage beyond the assured maintenance range may occur.
---	--

4.2 Mechanical installation

4.2.1 Installation environment

The installation environment is the safeguard for a full performance and long-term stable functions of the inverter. Check the installation environment as followings:

Environment	Conditions
Installation site	Indoor
Environment temperature	<p>-10~+50℃</p> <p>If the ambient temperature of the inverter is above 40℃, derate 3% for every additional 1℃.</p> <p>It is not recommended to use the inverter if the ambient temperature is above 50℃.</p> <p>In order to improve the reliability of the device, do not use the inverter if the ambient temperature changes frequently.</p> <p>Please provide cooling fan or air conditioner to control the internal ambient temperature below the required one if the inverter is used in a close space such as in the control cabinet.</p> <p>When the temperature is too low, if the inverter needs to restart to</p>

Environment	Conditions
	run after a long stop, it is necessary to provide an external heating device to increase the internal temperature, otherwise damage to the devices may occur.
Humidity	RH≤90% No condensation is allowed. The maximum relative humidity should be equal to or less than 60% in corrosive air.
Storage temperature	-30~+60℃
Running environment condition	The installation site of the inverter should: keep away from the electromagnetic radiation source; keep away from contaminative air, such as corrosive gas, oil mist and flammable gas; ensure foreign objects, such as metal power, dust, oil, water can not enter into the inverter(do not install the inverter on the flammable materials such as wood); keep away from direct sunlight, oil mist, steam and vibration environment.
Altitude	<1000m If the sea level is above 1000m, please derate 1% for every additional 100m.
Vibration	≤ 5.88m/s ² (0.6g)
Installation direction	The inverter should be installed on an upright position to ensure sufficient cooling effect.

Note:

- ◆ Goodrive35 series inverters should be installed in a clean and ventilated environment according to enclosure classification.
- ◆ Cooling air must be clean, free from corrosive materials and electrically conductive dust.

4.2.2 Installation direction

The inverter may be installed on the wall or in a cabinet.

The inverter must be installed in an upright position. Check the installation site according to the requirements below. Refer to chapter *Dimension Drawings* in the appendix for frame details.

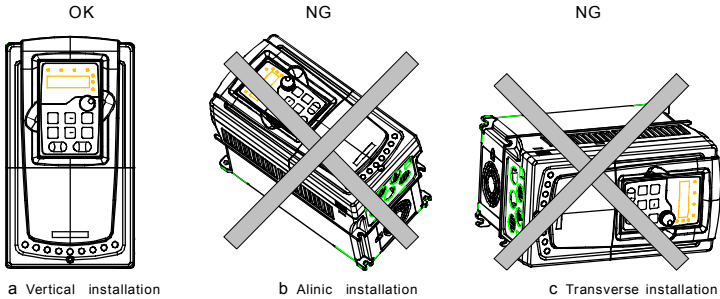

Fig 4-1 Installation direction of the inverter

4.2.3 Installation manner

The inverter can be installed in three different ways, depending on the frame size:

- a) Wall mounting (for the inverters of $380V \leq 315kW$ and the inverters of $660V \leq 350kW$)
- b) Flange mounting (for the inverters of $380V \leq 200kW$ and the inverters of $660V \leq 200kW$)
- c) Floor mounting (for the inverters of $380V$ 220~500kW and the inverters of $660V$ 250~630kW)

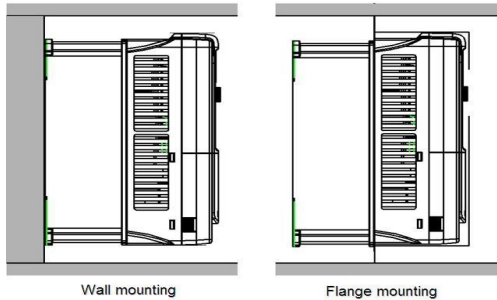

Fig 4-2 Installation manner

- (1) Mark the hole location. The location of the holes is shown in the dimension drawings in the appendix.
- (2) Fix the screws or bolts to the marked locations.
- (3) Put the inverter against the wall.
- (4) Tighten the screws in the wall securely.

Note: the flange installation of the inverters of $380V$ 1.5~30kW need flange board, while the flange installation of the inverters of $380V$ 37~200kW and $660V$ 22~220kW does not need.

The inverters of $380V$ 220~315kW and $660V$ 250~350 kW need optional bases and there is an input AC reactor (or DC reactor) and output AC reactor in the base.

4.2.4 Single installation

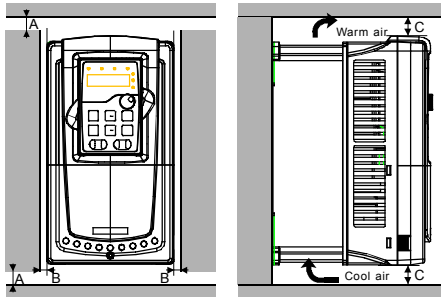

Fig 4-3 Single installation

Note: The minimum space of B and C is 100mm.

4.2.5 Multiple installations

Parallel installation

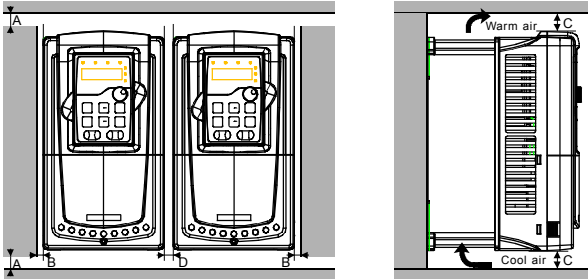

Fig 4-4 Parallel installation

Note: The minimum space of B, D and C is 100mm.

4.2.6 Vertical installation

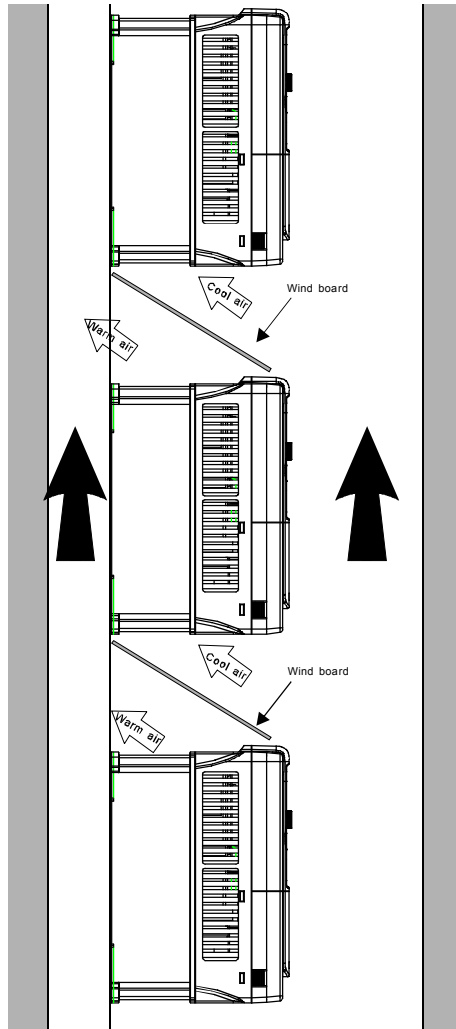

Fig 4-5 Vertical installation

Note: Windscreen should be installed in vertical installation for avoiding mutual impact and insufficient cooling.

4.2.7 Tilt installation

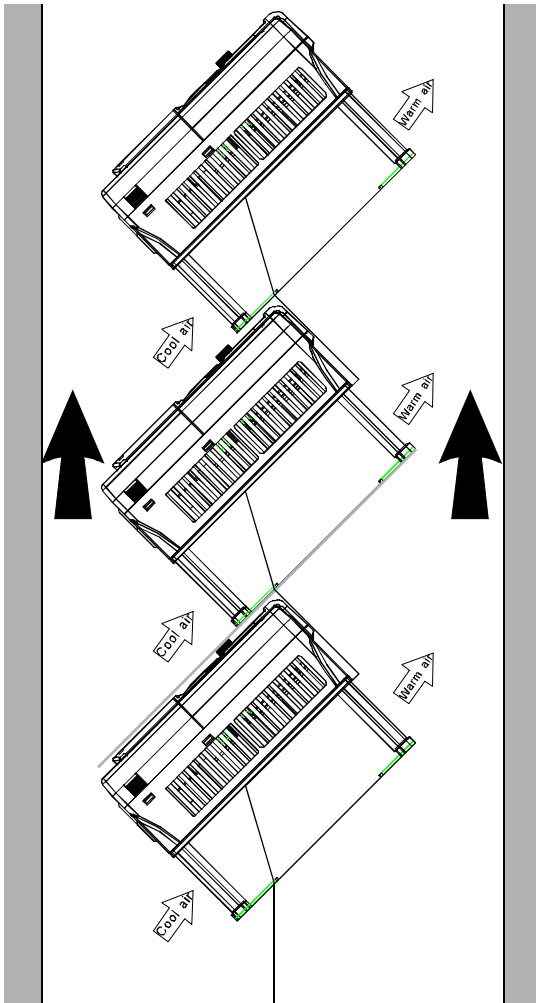

Fig 4-6 Tilt installation

Note: Ensure the separation of the wind input and output channels in tilt installation for avoiding mutual impact.

4.3 Standard wiring

4.3.1 Connection diagram of main circuit for the inverters of AC 3PH 380V(-15%)~440V(+10%)

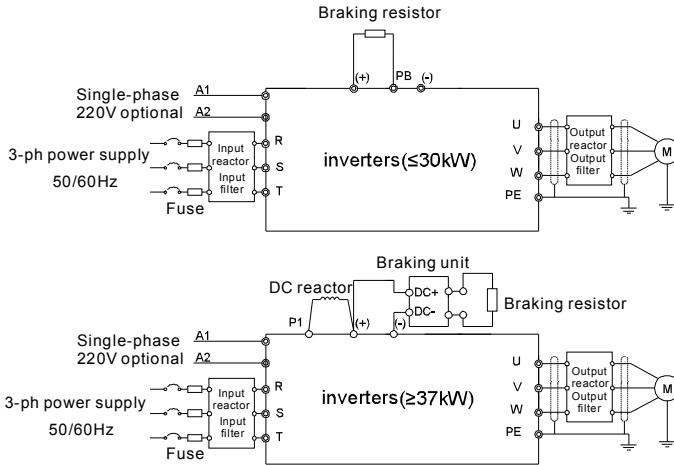

Fig 4-7 Connection diagram of main circuit for the inverters of 380V

Note:

- ◆ The fuse, DC reactor, braking unit, braking resistor, input reactor, input filter, output reactor, output filter are optional parts. Please refer to *Peripheral Optional Parts* for detailed information.
- ◆ A1 and A2 are optional parts.
- ◆ P1 and (+) are short circuited in factory for the inverters of 380V (≥37kW), if need to connect with the DC reactor, please remove the contact tag between P1 and (+).

4.3.1.2 Connection diagram of main circuit for the inverters of AC 3PH

520V(-15%)~690V(+10%)

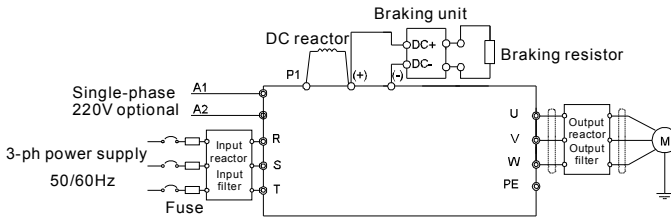

Fig 4-8 Connection diagram of main circuit for the inverters of 660V

Note:

1. The fuse, DC reactor, braking unit, braking resistor, input reactor, input filter, output reactor, output

filter are optional parts. Please refer to *Peripheral Optional Parts* for detailed information.

2. P1 and (+) are short circuited in factory, if need to connect with the DC rector, please remove the contact tag between P1 and (+).

4.3.2 Terminals figure of main circuit

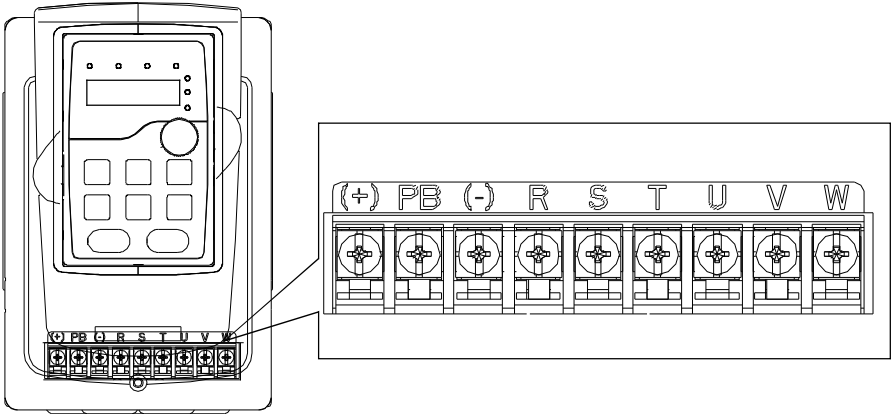

Fig 4-9 Terminals of main circuit for the inverters of 380V 1.5~2.2kW

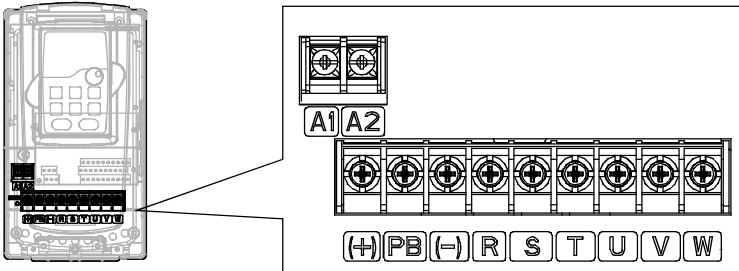

Fig 4-10 Terminals of main circuit for the inverters of 380V 4~5.5 kW

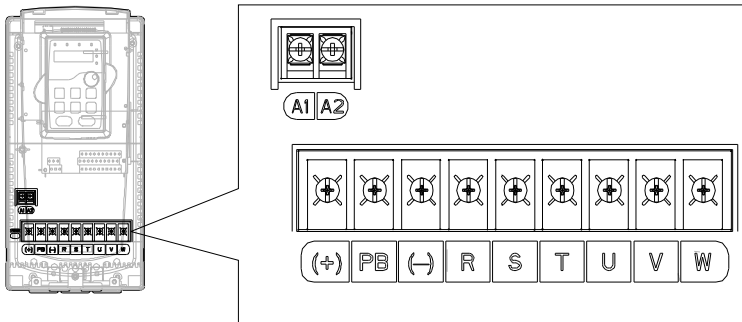

Fig 4-11 Terminals of main circuit for the inverters of 380V 7.5~11kW

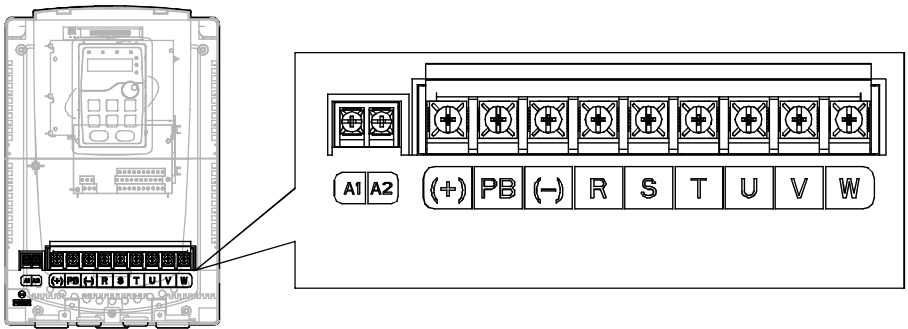

Fig 4-12 Terminals of main circuit for the inverters of 380V 15~18kW

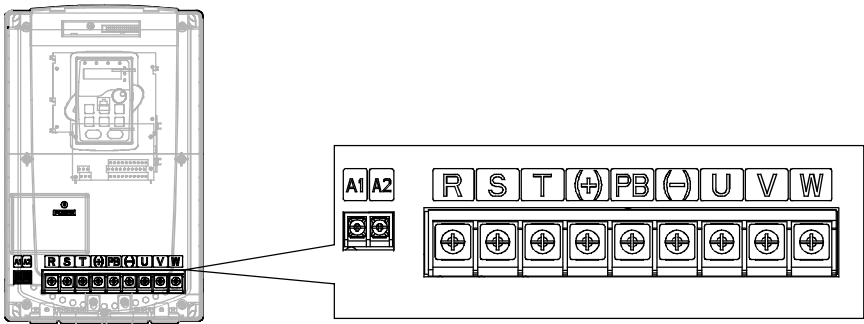

Fig 4-13 Terminals of main circuit for the inverters of 380V 22~30kW

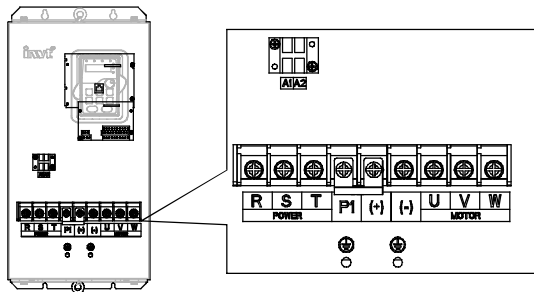

Fig 4-14 Terminals of main circuit for the inverters of 380V 37~55kW

Fig 4-14 Terminals of main circuit for the inverters of 660V 22~45kW

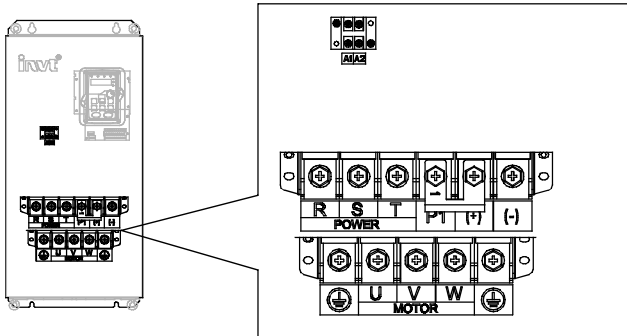

Fig 4-15 Terminals of main circuit for the inverters of 380V 75~110kW

Fig 4-15 Terminals of main circuit for the inverters of 660V 55~132kW

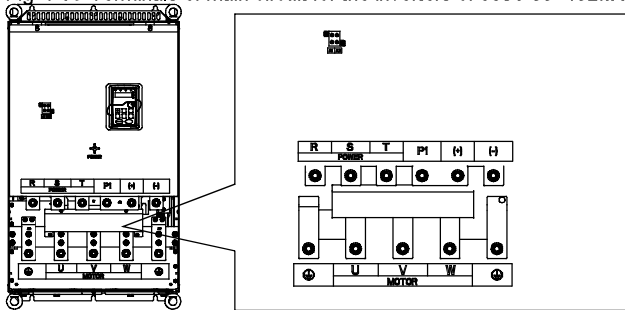

Fig 4-16 Terminals of main circuit for the inverters of 380V 132~200kW

Fig 4-16 Terminals of main circuit for the inverters of 660V 160~220kW

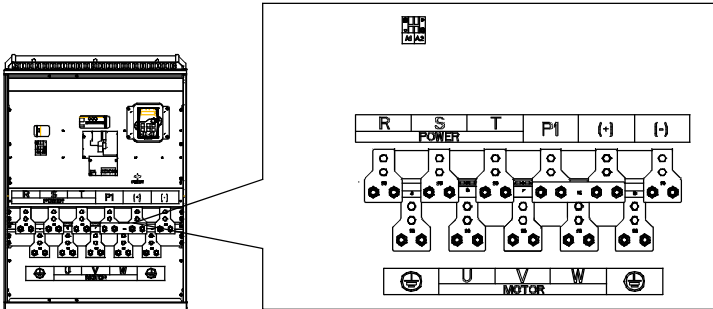

Fig 4-17 Terminals of main circuit for the inverters of 380V 220~315kW

Fig 4-17 Terminals of main circuit for the inverters of 660V 250~350kW

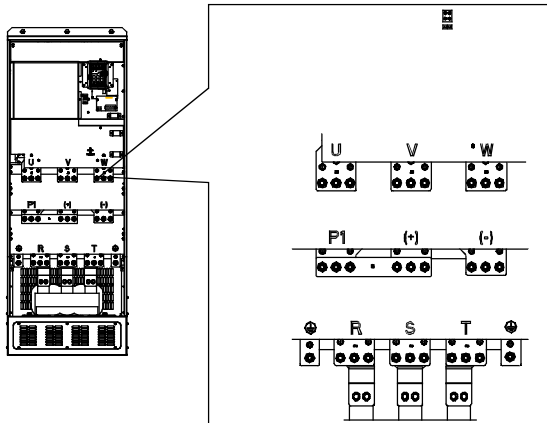

Fig Terminals of main circuit for the inverters of 4-18 380V 350~500kW

Fig Terminals of main circuit for the inverters of 4-18 660V 400~630kW

Terminal	Terminal name		Function
	380V	380V ≥37kW	
	≤30kW	660V	
R,S,T	Power input of the main circuit		3-phase AC input terminals which are generally connected with the power supply.
U,V,W	The inverter output		3-phase AC output terminals which are generally connected with the motor.
P1	/	DC reactor terminal 1	P1 and (+) are connected with the terminals of DC reactor. (+) and (-) are connected with the terminals of braking unit.
(+)	Braking resistor 1	DC reactor terminal 2, braking unit terminal 1	
(-)	/	Braking unit terminal 2	
PB	Braking resistor 2	/	
PE	380V: the grounding resistor is less than 10Ohm		Protective grounding terminals, every machine is provided 2 PE terminals as the standard configuration. These terminals should be grounded with proper techniques.
	660V: the grounding resistor is less than 10Ohm		
A1 and A2	Control power supply terminal		Optional for the inverters of 380V, standard for the inverters of 660V(with external 220V control power supply)

Terminal	Terminal name		Function
	380V	380V ≥37kW	
	≤30kW	660V	
			If no voltage is present on the main circuit, more convenient and safer commissioning is available through the auxiliary power supply.

Note:

- ◆ Do not use an asymmetrically constructed motor cable. If there is a symmetrically constructed grounding conductor in the motor cable in addition to the conductive shield, connect the grounding conductor to the grounding terminal at the inverter and motor ends.
- ◆ Braking resistor, braking unit and DC reactor are optional parts.
- ◆ Route the motor cable, input power cable and control cables separately.
- ◆ If the terminal description is "f", the machine does not provide the terminal as the external terminal.

4.3.3 Wiring of terminals in main circuit

1. Fasten the grounding conductor of the input power cable with the grounding terminal of the inverter (PE) by 360 degree grounding technique. Connect the phase conductors to R, S and T terminals and fasten.
2. Strip the motor cable and connect the shield to the grounding terminal of the inverter by 360 degree grounding technique. Connect the phase conductors to U, V and W terminals and fasten.
3. Connect the optional brake resistor with a shielded cable to the designated position by the same procedures in the previous step.
4. Secure the cables outside the inverter mechanically.

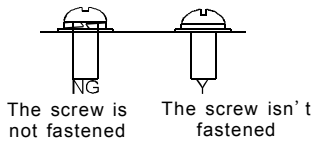

Fig 4-19 Correct installation of the screw

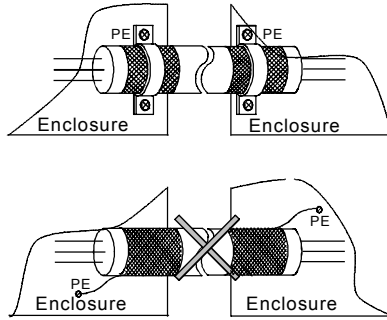

Fig 4-20 360 degree grounding technique

4.4 Standard wiring (control circuit)

4.4.1 Wiring diagram of control circuit

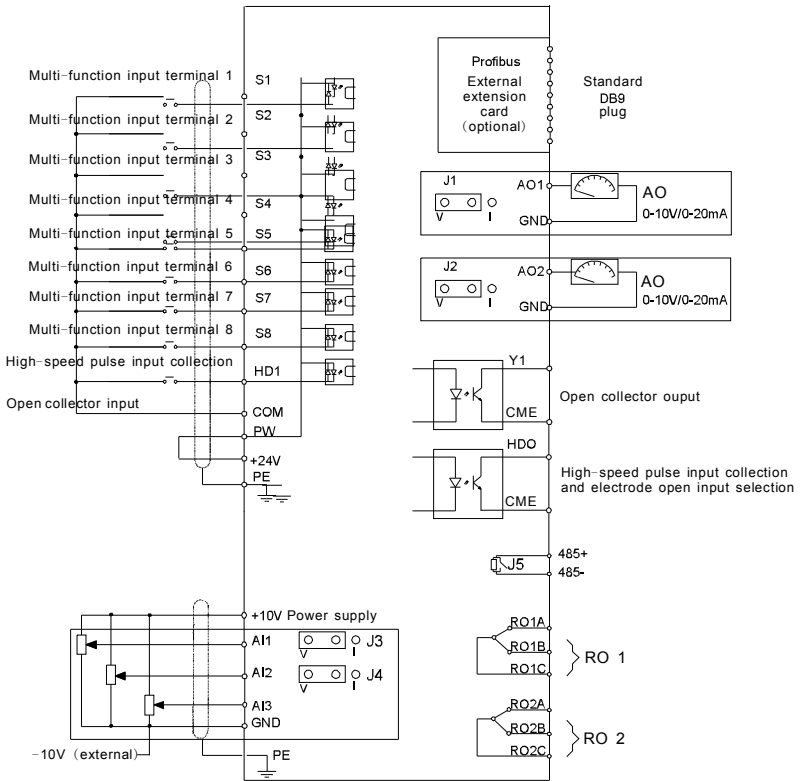
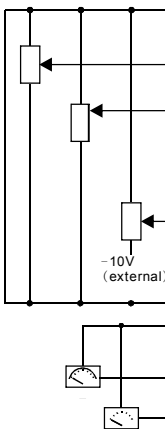

Fig 4-21 Wiring of control circuit



Terminal name	Description
+10V	Local power supply +10V
AI1	1. Input range: AI1/AI2 voltage and current can be chose: 0~10V/0~20mA; AI1 can be shifted by J1; AI2 can be shifted by J2 AI3: -10V~+10V 2. Input impedance: voltage input: 20kΩ; current input: 500Ω 3. Resolution: the minimum one is 5mV when 10V corresponds to 50Hz 4. Deviation $\pm 1\%$, 25°C
AI2	
AI3	
GND	+10V reference null potential
AO1	1. Output range: 0~10V or -20~20mA 2. The voltage or the current output is depended on the jumper. AO1 is switched by J1 and AO2 is switched by J2 3. Deviation $\pm 1\%$, 25°C
AO2	

Terminal name	Description
RO1A	RO1 relay output, RO1A NO, RO1B NC, RO1C common terminal Contactor capability: 3A/AC250V, 1A/DC30V
RO1B	
RO1C	
RO2A	RO2 relay output, RO2A NO, RO2B NC, RO2C common terminal Contactor capability: 3A/AC250V, 1A/DC30V
RO2B	
RO2C	

Terminal name	Description	
PE	Grounding terminal	
PW	Provide the input switch working power supply from external to internal. Voltage range: 12~24V	
24V	The inverter provides the power supply for users with a maximum output current of 200mA	
COM	+24V common terminal	
S1	Switch input 1	1. Internal impedance:3.3kΩ 2. 12~30V voltage input is available 3. The terminal is the dual-direction input terminal supporting both NPN and PNP 4. Max input frequency:1kHz 5. All are programmable digital input terminal. User can set the terminal function through function codes.
S2	Switch input 2	
S3	Switch input 3	
S4	Switch input 4	
S5	Switch input 5	
S6	Switch input 6	
S7	Switch input 7	
S8	Switch input 8	
HDI	Except for S1~S8, this terminal can be used as high frequency input channel. Max. input frequency:50kHz	
Terminal name	Description	
24V	The inverter provides the power supply for users with a maximum output current of 200mA	
HDO	1. Switch input: 200mA/30V 2. Output frequency range: 0~50kHz	
COM	+24V common terminal	
CME	Common terminal of the open collector pole output	
Y	1.Switch capability: 200mA/30V 2.Output frequency range: 0~1kHz	
485+	485 communication interface and 485 differential signal interface	
485-	If it is the standard 485 communication interface, please use twisted pairs or shield cable.	

4.4.2 C1 terminal (EC-PG301-24) and the wiring diagram

4.4.2.1 Terminal arrangement

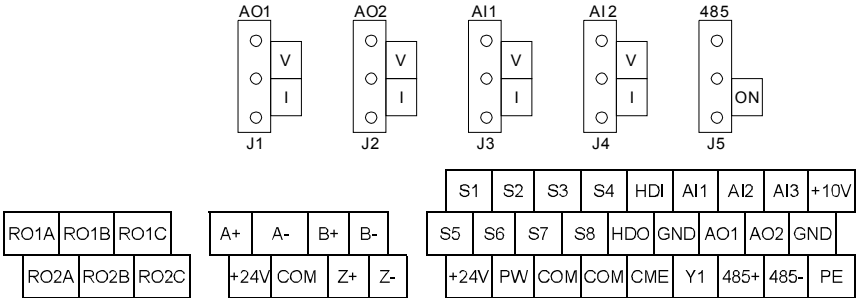

4.4.2.2 The terminal

Terminal	Instruction
+24V	Power supply, provide 24V, 200mA power supply
A+, A-, B+, B-, Z+, Z-	Signal input
COM1	Grounding terminal of the encoder

Note: refer to section 4.4.1 for detailed information of AO1, AO2, AI1, AI2, 485 and other terminals.

4.4.2.3 The wiring diagram

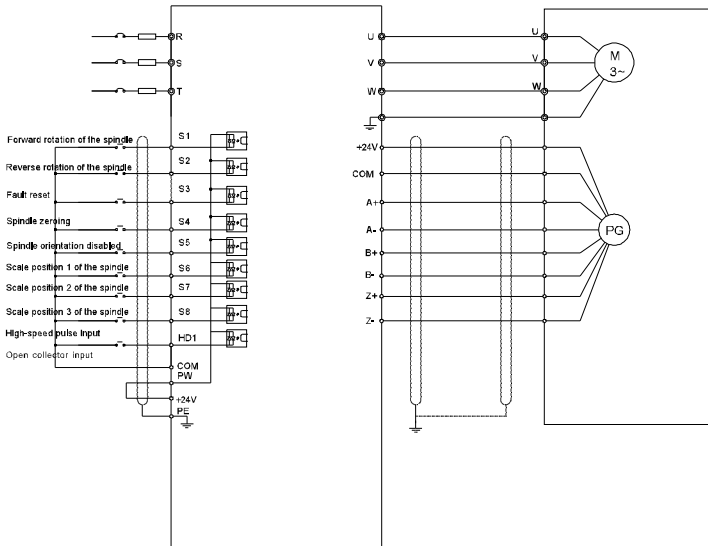

4.4.3 D1 terminal (EC-PG304-05) and the wiring diagram

4.4.3.1 Terminal arrangement

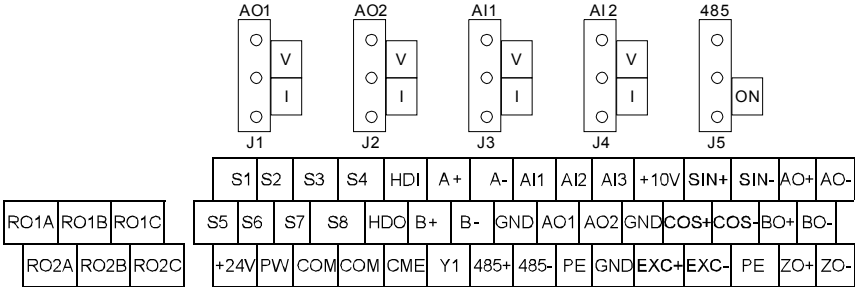

4.4.3.2 The terminal

Terminal	Instruction
EXC+EXC-	Exciting signal
SIN+, SIN-, COS+ and COS-	Signal input
A+, A-, B+, B-	Pulse reference signal, default as 5V input. External current-limiting resistor is needed when the input voltage is above 10V
AO+, AO-, BO+, BO-, ZO+, ZO-	Encoder signal output, 5V differential signal and the ratio of frequency-division is 1:1

Note: refer to section 4.4.1 for detailed information of AO1, AO2, AI1, AI2, 485 and other terminals.

4.4.3.3 The wiring diagram

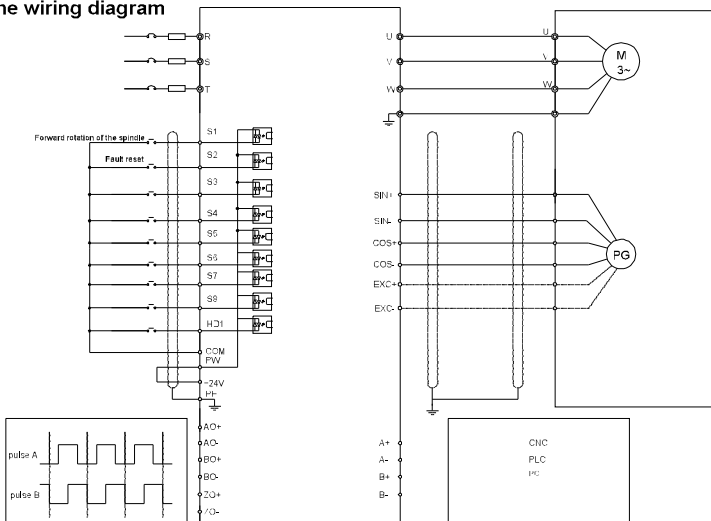

4.4.4 H1 terminal (EC-PG305-12) and the wiring diagram

4.4.4.1 Terminal arrangement

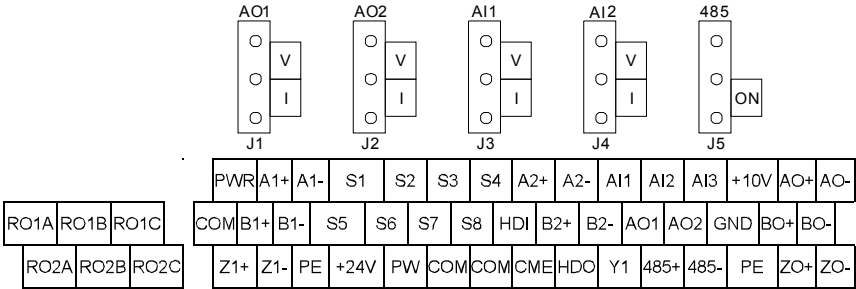

4.4.4.2 The terminal

Terminal	Instruction
PWR	Power supply, provide 5V/12V, 200mA power supply
A1+, A1-, B1+, B1-, Z1+, Z1-	Signal input
A2+, A2-, B2+, B2-,	Pulse reference signal, default as 5V input. External current-limiting resistor is needed when the input voltage is above 10V
AO+, AO-, BO+, BO-, ZO+ and ZO-	Encoder signal output, 5V differential signal and the ratio of frequency-division is 1:1
COM	Grounding terminal of the encoder

Note: refer to section 4.4.1 for detailed information of AO1, AO2, AI1, AI2, 485 and other terminals.

4.4.4.3 The wiring diagram

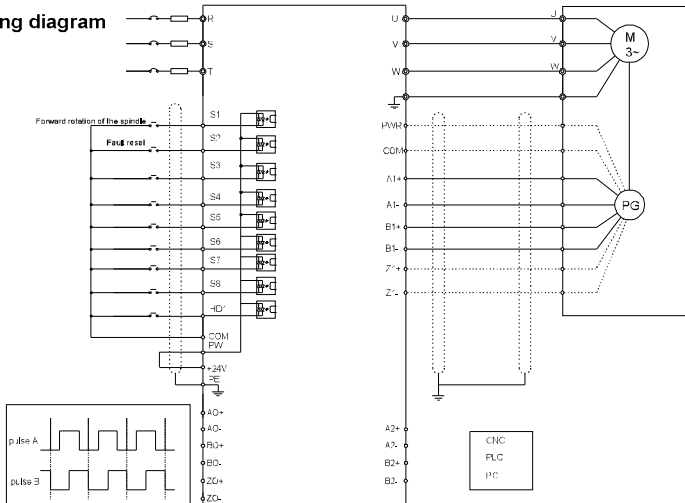

4.4.5 H2 terminal (EC-PG305-05) and the wiring diagram

4.4.5.1 Terminal arrangement

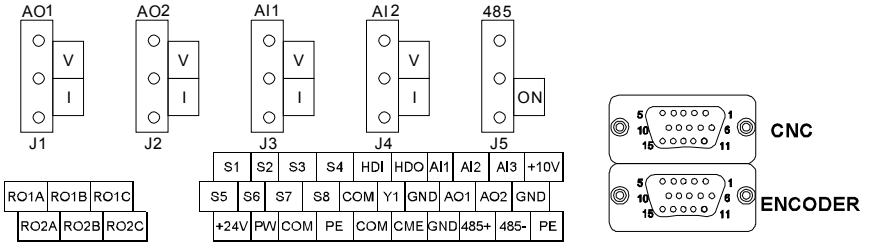

4.4.5.2 Interfaces

DB15(CNC)	CNC system interface	DB15(ENCODER)	Encoder interface
1	AO+	1	+5V
2	AO-	2	A1+
3	BO+	3	B1+
4	BO-	4	Z1+
5	ZO+	5	U+
6	ZO-	6	U-
7	CME	7	V+
8	COM	8	V-
9	S7	9	GND
10	S8	10	A1-
11	A2+	11	B1-
12	A2-	12	Z1-
13	B2+	13	W+
14	B2-	14	W-
15	COM	15	

4.4.5.3 The terminal

Terminal name (CNC)	Instruction
A2+, A2-, B2+, B2-	5V differential pulse+direction reference signal, Maximum supporting frequency 400 kHz
AO+, AO-, BO+, BO-, ZO+, ZO-	Encoder signal output, 5V differential signal and the ratio of frequency-division is 1:1
CME, COM	Alarm output(If use this function, it is necessary to short-connect Y terminal and +24V terminal, and remove the tag between CME and COM terminal)
S7, S8	Common switch input (be used as running and clear signal)
Terminal name (ENCODER)	Instruction
+5V, GND	Encoder power supply, to support 5V±5%, 200mA power
A1+, A1-, B1+, B1-, Z1+, Z1-	The encoder differential input signal, Maximum supporting frequency 400 kHz
U+, U-, V+, V-, W+, W-	Difference angle input signal input of UVW encoders (not for incremental encoders)

Note: refer to section 4.4.1 for detailed information of AO1, AO2, AI1, AI2, 485 and other terminals.

4.4.5.4 The wiring diagram

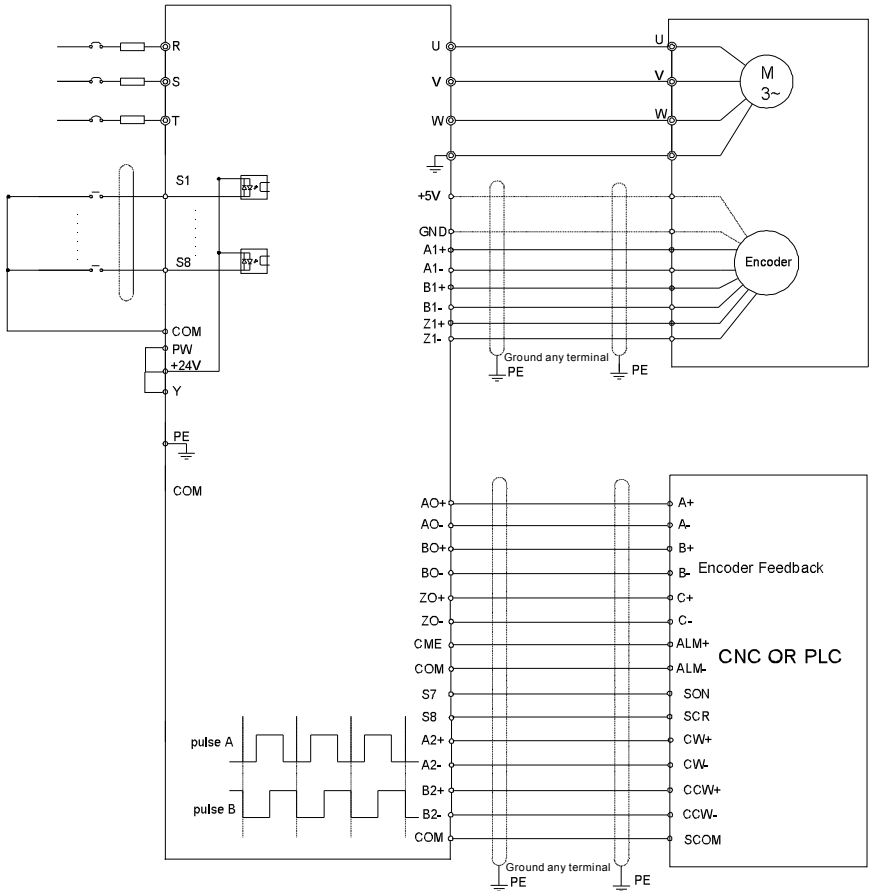

4.4.8 Input /Output signal connection figure

Please use U-shaped contact tag to set NPN mode or PNP mode and the internal or external power supply. The default setting is NPN internal mode.

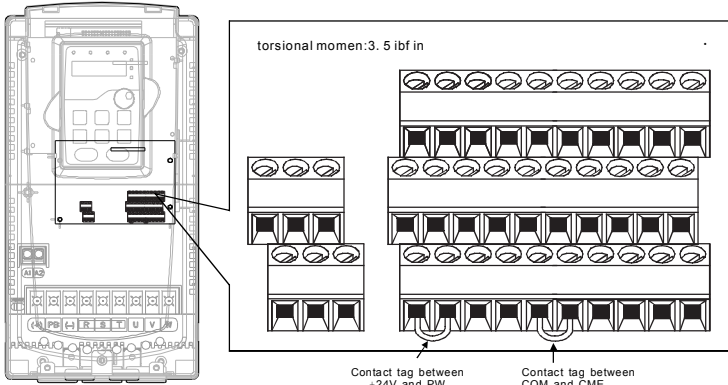

Fig 4-22 U-shaped contact tag

If the signal is from NPN transistor, please set the U-shaped contact tag between +24V and PW as below according to the used power supply.

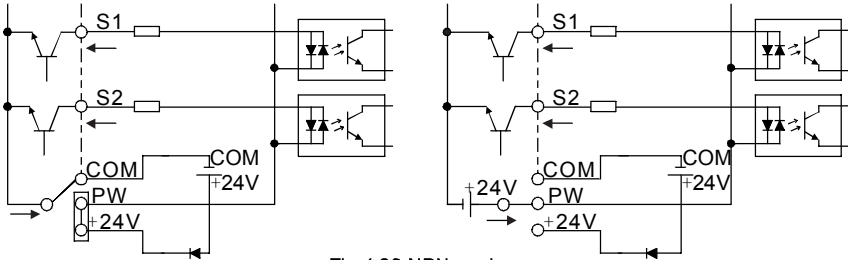

Fig 4-23 NPN modes

If the signal is from PNP transistor, please set the U-shaped contact tag as below according to the used power supply.

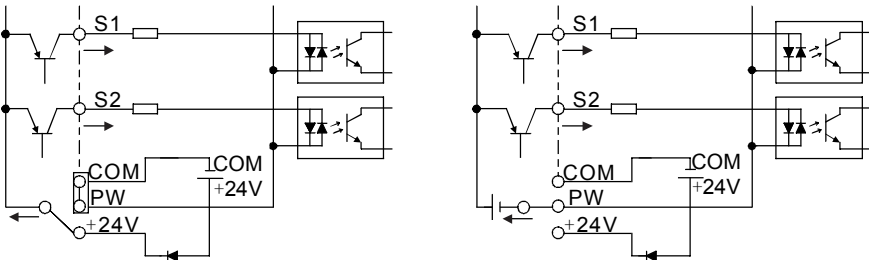

Fig 4-24 PNP modes

4.5 Layout protection

4.5.1 Protecting the inverter and input power cable in short-circuit situations

Protect the inverter and input power cable in short circuit situations and against thermal overload.

Arrange the protection according to the following guidelines.

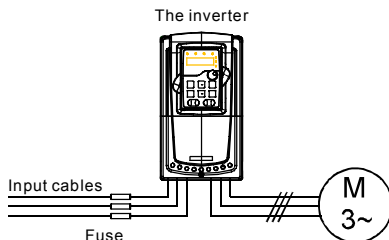

Fig 4-25 Fuse configuration

Note: Select the fuse as the manual indicated. The fuse will protect the input power cable from damage in short-circuit situations. It will protect the surrounding devices when the internal of the inverter is short circuited.

4.5.2 Protecting the motor and motor cable in short-circuit situations

The inverter protects the motor and motor cable in a short-circuit situation when the motor cable is dimensioned according to the rated current of the inverter. No additional protection devices are needed.



↪If the inverter is connected to multiple motors, a separate thermal overload switch or a circuit breaker must be used for protecting each cable and motor. These devices may require a separate fuse to cut off the short-circuit current.

4.5.3 Protecting the motor against thermal overload

According to regulations, the motor must be protected against thermal overload and the current must be switched off when overload is detected. The inverter includes a motor thermal protection function that protects the motor and closes the output to switch off the current when necessary.

4.5.4 Implementing a bypass connection

It is necessary to set power frequency and variable frequency conversion circuits for the assurance of continuous normal work of the inverter if faults occur in some significant situations.

In some special situations, for example, if it is only used in soft start, the inverter can be converted into power frequency running after starting and some corresponding bypass should be added.



↔ Never connect the supply power to the inverter output terminals U, V and W.
Power line voltage applied to the output can result in permanent damage to the inverter.

If frequent shifting is required, employ mechanically connected switches or contactors to ensure that the motor terminals are not connected to the AC power line and inverter output terminals simultaneously.

Keypad operation procedure

5

5.1 What this chapter contains

This chapter contains following operation:

- Buttons, indicating lights and the screen as well as the methods to inspect, modify and set function codes by keypad

5.2 Keypad

The keypad is used to control Goodrive35 series inverters, read the state data and adjust parameters.

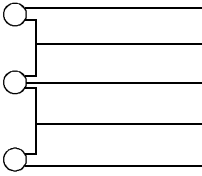































Fig 5-1 Keypad

Note:

1. The LED keypad is standard but the LCD keypad which can support various languages, parameters copy, 10-line displaying is optional and its installation dimension is compatible with the LED keypad.
2. It is necessary to use M3 screw or installation bracket to fix the external keypad. The installation bracket for inverters of 380V 1.5~30kW is optional but it is standard for the inverters of 380V 37~500kW and the inverters of 660V.

No.	Name	Description	
1	State LED	RUN/TUNE	LED off means that the inverter is in the stopping state; LED blinking means the inverter is in the parameter autotune state; LED on means the inverter is in the running state.
		FWD/REV	FED/REV LED LED off means the inverter is in the

No.	Name	Description					
			forward rotation state; LED on means the inverter is in the reverse rotation state				
		LOCAL/REMOT	LED for keypad operation, terminals operation and remote communication control LED off means that the inverter is in the keypad operation state; LED blinking means the inverter is in the terminals operation state; LED on means the inverter is in the remote communication control state.				
		TRIP	LED for faults LED on when the inverter is in the fault state; LED off in normal state; LED blinking means the inverter is in the pre-alarm state.				
2	Unit LED	Mean the unit displayed currently					
			Hz	Frequency unit			
			RPM	Rotating speed unit			
			A	Current unit			
			%	Percentage			
			V	Voltage unit			
3	Code displaying zone	5-figure LED display displays various monitoring data and alarm code such as set frequency and output frequency.					
		Displayed word	Corresponding word	Displayed word	Corresponding word	Displayed word	Corresponding word
		0	1	1	2	2	
		3	4	4	5	5	
		6	7	7	8	8	

No.	Name	Description					
			9		A		B
			C		d		E
			F		H		I
			L		N		n
			o		P		r
			S		t		U
			v		.		-
4	Digital potentiometer	Tuning frequency. Please refer to P08.41.					
5	Buttons		Programming key	Enter or escape from the first level menu and remove the parameter quickly			
			Entry key	Enter the menu step-by-step Confirm parameters			
			UP key	Increase data or function code progressively			
			DOWN key	Decrease data or function code progressively			
			Right-shift key	Move right to select the displaying parameter circularly in stopping and running mode. Select the parameter modifying digit during the parameter modification			
			Run key	This key is used to operate on the inverter in key operation mode			
			Stop/ Reset key	This key is used to stop in running state and it is limited by function code P07.04 This key is used to reset all control modes in the fault alarm state			
			Quick key	The function of this key is confirmed by function code P07.02.			

5.3 Keypad displaying

The keypad displaying state of Goodrive35 series inverters is divided into stopping state parameter, running state parameter, function code parameter editing state and fault alarm state and so on.

5.3.1 Displayed state of stopping parameter

When the inverter is in the stopping state, the keypad will display stopping parameters which is shown in figure 5-2.

In the stopping state, various kinds of parameters can be displayed. Select the parameters to be displayed or not by P07.07. See the instructions of P07.07 for the detailed definition of each bit.

In the stopping state, there are 14 stopping parameters can be selected to be displayed or not. They are: set frequency, bus voltage, input terminals state, output terminals state, PID given value, PID feedback value, torque set value, AI1, AI2, AI3, HDI, PLC and the current stage of multi-step speeds, pulse counting value, length value. P07.07 can select the parameter to be displayed or not by bit and **»/SHIFT** can shift the parameters from left to right, **QUICK/JOG**(P07.02=2) can shift the parameters from right to left.

5.3.2 Displayed state of running parameters

After the inverter receives valid running commands, the inverter will enter into the running state and the keypad will display the running parameters. **RUN/TUNE** LED on the keypad is on, while the **FWD/REV** is determined by the current running direction which is shown as figure 5-2.

In the running state, there are 24 parameters can be selected to be displayed or not. They are: running frequency, set frequency, bus voltage, output voltage, output torque, PID given value, PID feedback value, input terminals state, output terminals state, torque set value, length value, PLC and the current stage of multi-step speeds, pulse counting value, AI1, AI2, AI3, HDI, percentage of motor overload, percentage of inverter overload, ramp given value, linear speed, AC input current. P07.05 and P07.06 can select the parameter to be displayed or not by bit and **»/SHIFT** can shift the parameters from left to right, **QUICK/JOG**(P07.02=2) can shift the parameters from right to left.

5.3.3 Displayed state of fault

If the inverter detects the fault signal, it will enter into the fault pre-alarm displaying state. The keypad will display the fault code by flicking. The **TRIP** LED on the keypad is on, and the fault reset can be operated by the **STOP/RST** on the keypad, control terminals or

communication commands.

5.3.4 Displayed state of function codes editing

In the state of stopping, running or fault, press **PRG/ESC** to enter into the editing state (if there is a password, see P07.00). The editing state is displayed on two classes of menu, and the order is: function code group/function code number→function code parameter, press **DATA/ENT** into the displayed state of function parameter. On this state, you can press **DATA/ENT** to save the parameters or press **PRG/ESC** to retreat.

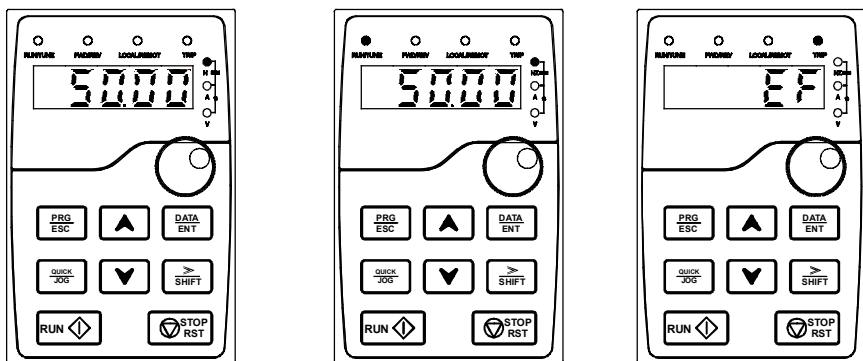

Fig 5-2 Displayed state

5.4 Keypad operation

Operate the inverter via operation panel. See the detailed structure description of function codes in the brief diagram of function codes.

5.4.1 How to modify the function codes of the inverter

The inverter has three levels menu, which are:

1. Group number of function code (first-level menu)
2. Tab of function code (second-level menu)
3. Set value of function code (third-level menu)

Remarks: Press both the **PRG/ESC** and the **DATA/ENT** can return to the second-level menu from the third-level menu. The difference is: pressing **DATA/ENT** will save the set parameters into the control panel, and then return to the second-level menu with shifting to the next function code automatically; while pressing **PRG/ESC** will directly return to the second-level menu without saving the parameters, and keep staying at the current function code.

Under the third-level menu, if the parameter has no flickering bit, it means the function code

cannot be modified. The possible reasons could be:

- 1) This function code is not modifiable parameter, such as actual detected parameter, operation records and so on;
- 2) This function code is not modifiable in running state, but modifiable in stop state.

Example: Set function code P00.01 from 0 to 1.

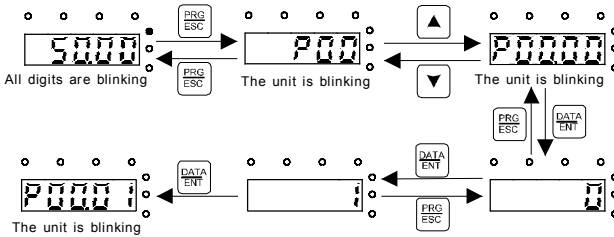

Fig 5-3 Sketch map of modifying parameters

5.4.2 How to set the password of the inverter

Goodrive35 series inverters provide password protection function to users. Set P7.00 to gain the password and the password protection becomes valid instantly after quitting from the function code editing state. Press **PRG/ESC** again to the function code editing state, “0.0.0.0.0” will be displayed. Unless using the correct password, the operators cannot enter it.

Set P7.00 to 0 to cancel password protection function.

The password protection becomes effective instantly after retreating from the function code editing state. Press **PRG/ESC** again to the function code editing state, “0.0.0.0.0” will be displayed. Unless using the correct password, the operators cannot enter it.

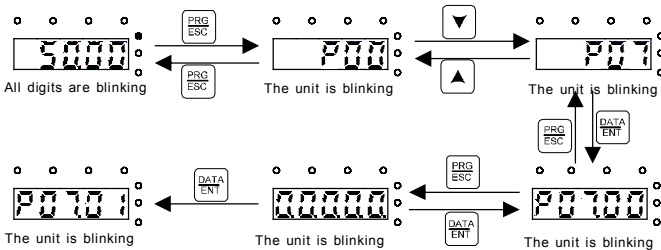

Fig 5-4 Sketch map of password setting

5.4.3 How to watch the inverter state through function codes

Goodrive35 series inverters provide group P17 as the state inspection group. Users can enter into P17 directly to watch the state.

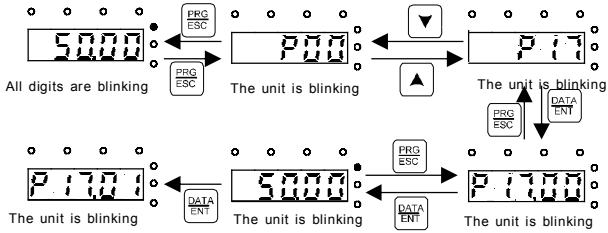

Fig 5-5 Sketch map of state watching

Function parameters

6

6.1 What this chapter contains

This chapter lists and describes the function parameters.

6.2 Goodrive35 general series function parameters

The function parameters of Goodrive35 series inverters have been divided into 30 groups (P00~P29) according to the function, of which P18~P28 are reserved. Each function group contains certain function codes applying 3-level menus. For example, "P08.08" means the eighth function code in the P8 group function, P29 group is factory reserved, and users are forbidden to access these parameters.

For the convenience of function codes setting, the function group number corresponds to the first level menu, the function code corresponds to the second level menu and the function code corresponds to the third level menu.

1. Below is the instruction of the function lists:

The first line "Function code": codes of function parameter group and parameters;

The second line "Name": full name of function parameters;

The third line "Detailed illustration of parameters": detailed illustration of the function parameters

The fourth line "Default value": the original factory values of the function parameter;

The fifth line "Modify": the modifying character of function codes (the parameters can be modified or not and the modifying conditions), below is the instruction:

“○”: means the set value of the parameter can be modified on stop and running state;

“⊙”: means the set value of the parameter can not be modified on the running state;

“●”: means the value of the parameter is the real detection value which can not be modified.

(The inverter has limited the automatic inspection of the modifying character of the parameters to help users avoid mismodifying)

2. "Parameter radix" is decimal (DEC), if the parameter is expressed by hex, then the parameter is separated from each other when editing. The setting range of certain bits are 0~F (hex).

3."The default value" means the function parameter will restore to the default value during default parameters restoring. But the detected parameter or recorded value won't be

restored.

4. For a better parameter protection, the inverter provides password protection to the parameters. After setting the password (set P07.00 to any non-zero number), the system will come into the state of password verification firstly after the user press **PRG/ESC** to come into the function code editing state. And then "0.0.0.0.0." will be displayed. Unless the user input right password, they cannot enter into the system. For the factory setting parameter zone, it needs correct factory password (remind that the users can not modify the factory parameters by themselves, otherwise, if the parameter setting is incorrect, damage to the inverter may occur). If the password protection is unlocked, the user can modify the password freely and the inverter will work as the last setting one. When P07.00 is set to 0, the password can be canceled. If P07.00 is not 0 during powering on, then the parameter is protected by the password. When modify the parameters by serial communication, the function of the password follows the above rules, too.

Function code	Name	Detailed instruction of parameters	Default value	Modify
P00 Group Basic function group				
P00.00	Speed control mode	0: Sensorless vector control mode 0 (apply to AM and SM) No need to install encoders. It is suitable in cases with low frequency, big torque and high speed control accuracy for accurate speed and torque control. Relative to mode 1, this mode is more suitable for medium and small power. 1: Sensorless vector control mode 1 (applying to AM) No need to install encoders. It is suitable in cases with high speed control accuracy for accurate speed and torque control at all power ratings. 2:SVPWM control No need to install encoders. It can improve the control accuracy with the advantages of stable operation, valid low-frequency torque boost and current vibration suppression and the functions of slip compensation and voltage adjustment. 3: Close loop vector control	2	⊙

Function code	Name	Detailed instruction of parameters	Default value	Modify
		<p>Need to install encoders. It is suitable in cases with low frequency, high speed control accuracy for accurate speed and torque control.</p> <p>Note: AM-Asynchronous motor SM-Synchronous motor</p>		
P00.01	Run command channel	<p>Select the run command channel of the inverter. The control command of the inverter includes: start-up, stop, forward, reverse, jogging and fault reset.</p> <p>0:Keypad running command channel("LOCAL/REMOT" light off) Carry out the command control by RUN, STOP/RST on the keypad.</p> <p>Set the multi-function key QUICK/JOG to FWD/REVC shifting function (P07.02=3) to change the running direction; press RUN and STOP/RST simultaneously in running state to make the inverter coast to stop.</p> <p>1:Terminal running command channel ("LOCAL/REMOT" flickering) Carry out the running command control by the forward rotation, reverse rotation and forward jogging and reverse jogging of the multi-function terminals</p> <p>2:Communication running command channel ("LOCAL/REMOT" on); The running command is controlled by the upper monitor via communication</p>	0	○
P00.02	Communication running commands	<p>Select the controlling communication command channel of the inverter.</p> <p>0: MODBUS communication channel 1: PROFIBUSICANopen communication channel 2: Ethernet communication channel 3: Reserved</p>	0	○

Function code	Name	Detailed instruction of parameters	Default value	Modify
		Note: 1, 2 and 3 are extension functions which need corresponding extension cards.		
P00.03	Max. output frequency	This parameter is used to set the maximum output frequency of the inverter. Users should pay attention to this parameter because it is the foundation of the frequency setting and the speed of acceleration and deceleration. Setting range: P00.04~400.00Hz	50.00 Hz	⊙
P00.04	Upper limit of the running frequency	The upper limit of the running frequency is the upper limit of the output frequency of the inverter which is lower than or equal to the maximum frequency. Setting range:P00.05~P00.03 (Max. output frequency)	50.00 Hz	⊙
P00.05	Lower limit of the running frequency	The lower limit of the running frequency is that of the output frequency of the inverter. The inverter runs at the lower limit frequency if the set frequency is lower than the lower limit one. Note: Max. output frequency ≥ Upper limit frequency ≥ Lower limit frequency Setting range:0.00Hz~P00.04 (Upper limit of the running frequency)	0.00 Hz	⊙
P00.06	A frequency command	0:Keypad Modify the value P00.10 (set the frequency by keypad) to modify the frequency by the keypad.	0	○
P00.07	B frequency command	1: AI1 2: AI2 3: AI3 Set the frequency by analog input terminals. Goodrive35 series inverters provide 3 analog input terminals as the standard configuration, of which AI1/AI2 are the voltage/current option (0~10V/0~20mA) which can be shifted by jumpers; while AI3 is voltage input (-10V~+10V). Note: when analog AI1/AI2 select 0~20mA input, the	2	○

Function code	Name	Detailed instruction of parameters	Default value	Modify
		<p>corresponding voltage of 20mA is 10V.</p> <p>100.0% of the analog input setting corresponds to the maximum frequency (function code P00.03) in forward direction and -100.0% corresponds to the maximum frequency in reverse direction (function code P00.03)</p> <p>4:High-speed pulse HDI setting The frequency is set by high-speed pulse terminals. Goodrive35 series inverters provide 1 high speed pulse input as the standard configuration. The pulse frequency range is 0.00~50.00kHz.</p> <p>100.0% of the high speed pulse input setting corresponds to the maximum frequency in forward direction (P00.03) and -100.0% corresponds to the maximum frequency in reverse direction (P00.03). Note: The pulse setting can only be input by multi-function terminals HDI. Set P05.00 (HDI input selection) to high speed pulse input, and set P05.49 (HDI high speed pulse input function selection) to frequency setting input.</p> <p>5:Simple PLC program setting The inverter runs at simple PLC program mode when P00.06=5 or P00.07=5. Set P10 (simple PLC and multi-step speed control) to select the running frequency, running direction, ACC/DEC time and the keeping time of corresponding stage. See the function description of P10 for detailed information.</p> <p>6: Multi-step speed running setting The inverter runs at multi-step speed mode when P00.06=6 or P00.07=6. Set P05 to select the current running stage, and set P10 to select the current running frequency.</p> <p>The multi-step speed has the priority when P00.06 or P00.07 does not equal to 6, but the setting stage</p>		

Function code	Name	Detailed instruction of parameters	Default value	Modify
		<p>can only be the 1~15 stage. The setting stage is 0~15 if P00.06 or P00.07 equals to 6.</p> <p>7: PID control setting The running mode of the inverter is process PID control when P00.06=7 or P00.07=7. It is necessary to set P09. The running frequency of the inverter is the value after PID effect. See P09 for the detailed information of the given source, given value, feedback source of PID.</p> <p>8:MODBUS communication setting The frequency is set by MODBUS communication. See P14 for detailed information.</p> <p>9:PROFIBUS/CANopen communication setting The frequency is set by PROFIBUS/ CANopen communication. See P15 for the detailed information.</p> <p>10:Ethernet communication setting(reserved) See P16 for the detailed information.</p> <p>11:Reserved</p> <p>12:Pulse string AB setting</p> <p>Note:A frequency and B frequency can not set as the same frequency given method.</p>		
P00.08	B frequency command reference	<p>0:Maximum output frequency, 100% of B frequency setting corresponds to the maximum output frequency</p> <p>1: A frequency command, 100% of B frequency setting corresponds to the maximum output frequency. Select this setting if it needs to adjust on the base of A frequency command</p>	0	○
P00.09	Combination of the setting source	<p>0: A, the current frequency setting is A frequency command</p> <p>1: B, the current frequency setting is B frequency command</p> <p>2: A+B, the current frequency setting is A frequency</p>	0	○

Function code	Name	Detailed instruction of parameters	Default value	Modify
		command + B frequency command 3: A-B, the current frequency setting is A frequency command - B frequency command 4: Max (A, B): The bigger one between A frequency command and B frequency is the set frequency. 5: Min (A, B): The lower one between A frequency command and B frequency is the set frequency. Note: The combination manner can be shifted by P5 (terminal function)		
P00.10	Keypad set frequency	When A and B frequency commands are selected as "keypad setting", the value of the function code is the original setting one of the frequency data of the inverter. Setting range: 0.00 Hz~P00.03 (the Max. frequency)	50.00 Hz	<input type="radio"/>
P00.11	ACC time 1	ACC time means the time needed if the inverter speeds up from 0Hz to the Max. One (P00.03). DEC time means the time needed if the inverter speeds down from the Max. Output frequency to 0Hz (P00.03).	Depend on model	<input type="radio"/>
P00.12	DEC time 1	Goodrive35 series inverters define four groups of ACC/DEC time which can be selected by P05. The factory default ACC/DEC time of the inverter is the first group. Setting range of P00.11 and P00.12: 0.0~3600.0s	Depend on model	<input type="radio"/>
P00.13	Running direction	0: Runs at the default direction, the inverter runs in the forward direction. FWD/REV indicator is off. 1: Runs at the reverse direction, the inverter runs in the reverse direction. FWD/REV indicator is on. Modify the function code to shift the rotation direction of the motor. This effect equals to the shifting the rotation direction by adjusting either two of the motor lines (U, V and W). The motor rotation direction can be changed by QUICK/JOG on the keypad. Refer to	0	<input type="radio"/>

Function code	Name	Detailed instruction of parameters	Default value	Modify																									
		<p>parameter P07.02.</p> <p>Note: When the function parameter comes back to the default value, the motor's running direction will come back to the factory default state, too. In some cases it should be used with caution after commissioning if the change of rotation direction is disabled.</p> <p>2: Forbid to run in reverse direction: It can be used in some special cases if the reverse running is disabled.</p>																											
P00.14	Carrier frequency setting	<table border="1" data-bbox="341 608 767 807"> <thead> <tr> <th>Carrier frequency</th> <th>Electromagnetic noise</th> <th>Noise and leakage current</th> <th>Heating eliminating</th> </tr> </thead> <tbody> <tr> <td>1kHz</td> <td rowspan="3" style="text-align: center;">↑ High ↓ Low</td> <td rowspan="3" style="text-align: center;">↑ Low ↓ High</td> <td rowspan="3" style="text-align: center;">↑ Low ↓ High</td> </tr> <tr> <td>10kHz</td> </tr> <tr> <td>15kHz</td> </tr> </tbody> </table> <p>The relationship table of the motor type and carrier frequency:</p> <table border="1" data-bbox="341 879 767 1190"> <thead> <tr> <th colspan="2">Model</th> <th>The factory value of carrier frequency</th> </tr> </thead> <tbody> <tr> <td rowspan="3">380V</td> <td>1.5~11kW</td> <td>8kHz</td> </tr> <tr> <td>15~55kW</td> <td>4kHz</td> </tr> <tr> <td>Above 75kW</td> <td>2kHz</td> </tr> <tr> <td rowspan="2">660V</td> <td>22~55kW</td> <td>4kHz</td> </tr> <tr> <td>Above 75kW</td> <td>2kHz</td> </tr> </tbody> </table> <p>The advantage of high carrier frequency: ideal current waveform, little current harmonic wave and motor noise.</p> <p>The disadvantage of high carrier frequency: increasing the switch loss, increasing inverter temperature and the impact to the output capacity.</p> <p>The inverter needs to derate on high carrier</p>	Carrier frequency	Electromagnetic noise	Noise and leakage current	Heating eliminating	1kHz	↑ High ↓ Low	↑ Low ↓ High	↑ Low ↓ High	10kHz	15kHz	Model		The factory value of carrier frequency	380V	1.5~11kW	8kHz	15~55kW	4kHz	Above 75kW	2kHz	660V	22~55kW	4kHz	Above 75kW	2kHz	Depend on model	○
Carrier frequency	Electromagnetic noise	Noise and leakage current	Heating eliminating																										
1kHz	↑ High ↓ Low	↑ Low ↓ High	↑ Low ↓ High																										
10kHz																													
15kHz																													
Model		The factory value of carrier frequency																											
380V	1.5~11kW	8kHz																											
	15~55kW	4kHz																											
	Above 75kW	2kHz																											
660V	22~55kW	4kHz																											
	Above 75kW	2kHz																											

Function code	Name	Detailed instruction of parameters	Default value	Modify
		<p>frequency. At the same time, the leakage and electrical magnetic interference will increase.</p> <p>Applying low carrier frequency is contrary to the above, too low carrier frequency will cause unstable running, torque decreasing and surge.</p> <p>The manufacturer has set a reasonable carrier frequency when the inverter is in factory. In general, users do not need to change the parameter.</p> <p>When the frequency used exceeds the default carrier frequency, the inverter needs to derate 20% for each additional 1k carrier frequency.</p> <p>Setting range: 1.2~15.0kHz</p>		
P00.15	Motor parameter autotuning	<p>0:No operation</p> <p>1:Rotation autotuning</p> <p>Comprehensive motor parameter autotune</p> <p>It is recommended to use rotation autotuning when high control accuracy is needed.</p> <p>2: Static autotuning 1(autotune totally); It is suitable in the cases when the motor can not de-couple form the load. The autotuning for the motor parameter will impact the control accuracy.</p> <p>3: Static autotuning 2(autotune part parameters); when the current motor is motor 1, autotune P02.06, P02.07, P02.08; and when the current motor is motor 2, autotune P12.06, P12.07, P12.08.</p>	0	☉
P00.16	AVR function selection	<p>0:Invalid</p> <p>1:Valid during the whole procedure</p> <p>The auto-adjusting function of the inverter can cancel the impact on the output voltage of the inverter because of the bus voltage fluctuation.</p>	1	○
P00.17	Reserved	Reserved	0	☉
P00.18	Function restore	<p>0:No operation</p> <p>1:Restore the default value</p>	0	☉

Function code	Name	Detailed instruction of parameters	Default value	Modify
	parameter	2:Cancel the fault record Note: The function code will restore to 0 after finishing the operation of the selected function code. Restoring to the default value will cancel the user password, please use this function with caution.		
P01 Group Start-up and stop control				
P01.00	Start mode	0:Start-up directly:start from the starting frequency P01.01 1:Start-up after DC braking: start the motor from the starting frequency after DC braking (set the parameter P01.03 and P01.04). It is suitable in the cases where reverse rotation may occur to the low inertia load during starting. 2: Start-up after speed tracing: start the rotating motor smoothly after tracking the rotation speed and direction automatically. It is suitable in the cases where reverse rotation may occur to the big inertia load during starting. Note: The inverters above 4kW have the function.	0	⊙
P01.01	Starting frequency of direct start	Starting frequency of direct start-up means the original frequency during the inverter starting. See P01.02 for detailed information. Setting range: 0.00~50.00Hz	0.00 Hz	⊙
P01.02	Retention time of the starting frequency	Set a proper starting frequency to increase the torque of the inverter during starting. During the retention time of the starting frequency, the output frequency of the inverter is the starting frequency. And then, the inverter will run from the starting frequency to the set frequency. If the set frequency is lower than the starting frequency, the inverter will stop running and keep in the stand-by state. The starting frequency is not limited in the lower limit frequency.	0.0s	⊙

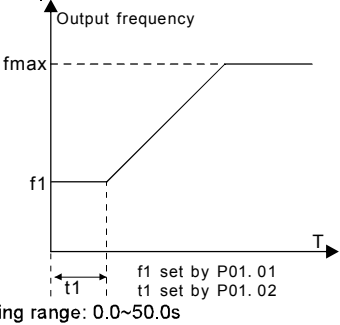
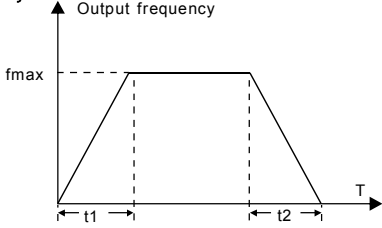
Function code	Name	Detailed instruction of parameters	Default value	Modify
		 <p>Setting range: 0.0~50.0s</p>		
P01.03	The braking current before starting	<p>The inverter will carry out DC braking at the braking current set before starting and it will speed up after the DC braking time. If the DC braking time is set to 0, the DC braking is invalid.</p> <p>The stronger the braking current, the bigger the</p>	0.0%	⊙
P01.04	The braking time before starting	<p>braking power. The DC braking current before starting means the percentage of the rated current of the inverter.</p> <p>The setting range of P01.03: 0.0~100.0%</p> <p>The setting range of P01.04: 0.0~30.0s</p>	0.0s	⊙
P01.05	ACC/DEC selection	<p>The changing mode of the frequency during start-up and running.</p> <p>0: Linear type</p> <p>The output frequency increases or decreases linearly.</p>  <p>1: S curve</p>	0	⊙
P01.06	ACC time of the	0.0~50.0s	0.1s	⊙

Function code	Name	Detailed instruction of parameters	Default value	Modify
	starting step of S curve	<p>t1=P01.06 t2=P01.07 t3=P01.06 t4=P01.07</p>		
P01.07	DEC time of the ending step of S curve		0.1s	⊙
P01.08	Stop mode	<p>0: Decelerate to stop: after the stop command becomes valid, the inverter decelerates to decrease the output frequency during the set time. When the frequency decreases to P01.15, the inverter stops.</p> <p>1: Coast to stop: after the stop command becomes valid, the inverter ceases the output immediately. And the load coasts to stop at the mechanical inertia.</p>	0	○
P01.09	Starting frequency of DC braking	The starting frequency of stop braking: the inverter will carry on stop DC braking when the frequency is arrived during the procedure of decelerating to stop. Demagnetizing time: before the stop DC braking, the	0.00 Hz	○
P01.10	Demagnetizing time	inverter will close output and begin to carry on the DC braking after the waiting time. This function is	0.00s	○
P01.11	DC braking current	used to avoid the overcurrent fault caused by DC braking when the speed is too high.	0.0%	○
P01.12	DC braking time	<p>Stop DC braking current: the DC brake added. The stronger the current, the bigger the DC braking effect.</p> <p>The braking time of stop braking: the retention time of DC brake. If the time is 0, the DC brake is invalid.</p> <p>The inverter will stop at the set deceleration time.</p>	0.0s	○

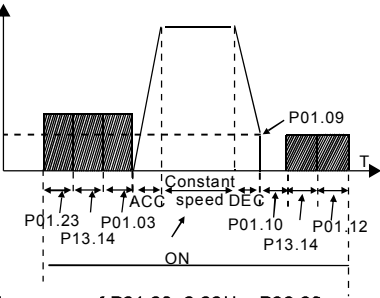
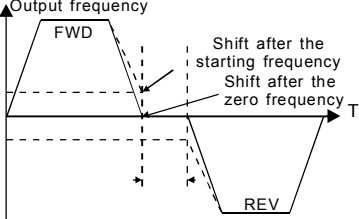
Function code	Name	Detailed instruction of parameters	Default value	Modify
		 <p>Setting range of P01.09: 0.00Hz~P00.03 Setting range of P01.10: 0.00~30.00s Setting range of P01.11: 0.0~100.0% Setting range of P01.12: 0.0~50.0s</p>		
P01.13	Dead time of FWD/REV rotation	During the procedure of switching for/rev rotation, set the threshold by P01.14, which is as the table below:  <p>Setting range: 0.0~3600.0s</p>	0.0s	○
P01.14	Shifting between FWD/REV rotation	Set the threshold point of the inverter: 0: Switch after zero frequency 1: Switch after the starting frequency	0	◎
P01.15	Stopping speed	0.00~100.00Hz	0.20 Hz	◎
P01.16	Detection of stopping speed	0: Detect according to speed setting (no stopping delay) 1: Detect according to speed feedback (only valid for vector control)	0	◎

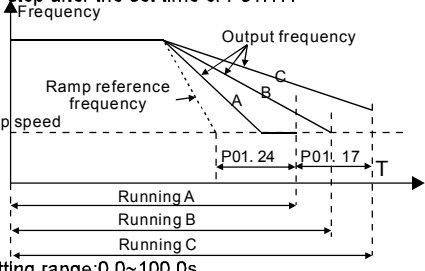
Function code	Name	Detailed instruction of parameters	Default value	Modify
P01.17	Detection time of the feedback speed	<p>If set P01.16 to 1, the feedback frequency is less than or equal to P01.15 and detect in the set time of P01.17, the inverter will stop; otherwise the inverter will stop after the set time of P01.17.</p>  <p>Setting range:0.0~100.0s (only valid when P01.16=1)</p>	0.5s	☉
P01.18	Terminal running protection when powering on	<p>When the running commands are controlled by the terminal, the system will detect the state of the running terminal during powering on.</p> <p>0: The terminal running command is invalid when powering on. Even the running command is detected to be valid during powering on, the inverter won't run and the system keeps in the protection state until the running command is canceled and enabled again.</p> <p>1: The terminal running command is valid when powering on. If the running command is detected to be valid during powering on, the system will start the inverter automatically after the initialization.</p> <p>Note: this function should be selected with cautions, or serious result may follow.</p>	0	○
P01.19	Action if running frequency < lower limit frequency	<p>This function code determines the running state of the inverter when the set frequency is lower than the lower-limit one.</p> <p>0: Run at the lower-limit frequency</p> <p>1: Stop</p>	0	☉

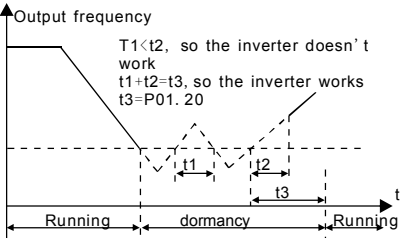
Function code	Name	Detailed instruction of parameters	Default value	Modify
	(valid >0)	<p>2: Hibernation</p> <p>3: Run at zero frequency</p> <p>The inverter will coast to stop when the set frequency is lower than the lower-limit one. If the set frequency is above the lower limit one again and it lasts for the time set by P01.20, the inverter will come back to the running state automatically.</p>		
P01.20	Hibernation restore delay time	<p>This function code determines the hibernation delay time. When the running frequency of the inverter is lower than the lower limit one, the inverter will pause to stand by.</p> <p>When the set frequency is above the lower limit one again and it lasts for the time set by P01.20, the inverter will run automatically.</p> <p>Note: The time is the total value when the set frequency is above the lower limit one.</p>  <p>Setting range: 0.0~3600.0s (valid when P01.19=2)</p>	0.0s	○
P01.21	Restart after power off	<p>This function can enable the inverter start or not after the power off and then power on.</p> <p>0: Disable</p> <p>1: Enable, if the starting need is met, the inverter will run automatically after waiting for the time defined by P01.22.</p>	0	○
P01.22	The waiting	<p>The function determines the waiting time before the automatic running of the inverter when powering off</p>	1.0s	○

Function code	Name	Detailed instruction of parameters	Default value	Modify
	time of restart after power off	<p>and then powering on.</p> <p>Setting range: 0.0~3600.0s (valid when P01.21=1)</p>		
P01.23	Start delay time	<p>The function determines the brake release after the running command is given, and the inverter is in a stand-by state and wait for the delay time set by P01.23</p> <p>Setting range: 0.00~60.00s</p>	0.00s	○
P01.24	Delay time of the stop speed	<p>Setting range: 0.00~60.00s</p>	0.00s	○
P01.25	DEC time of E-stop	<p>DEC time of E-stop.</p> <p>Setting range: 0.00~60.00s</p>	2.00s	○
P02 Group Motor 1				
P02.00	Motor type 1	<p>0:Asynchronous motor 1:Synchronous motor</p> <p>Note: Switch the current motor by the switching channel of P08.31.</p>	0	◎
P02.01	Rated power of asynchronous motor 1	<p>0.1~3000.0kW</p>	Depend on model	◎
P02.02	Rated frequency of asynchronous motor	<p>0.01Hz~P00.03(the Max. frequency)</p>	50.00 Hz	◎

Function code	Name	Detailed instruction of parameters	Default value	Modify
	1			
P02.03	Rated speed of asynchronous motor 1	1~36000rpm	Depend on model	☉
P02.04	Rated voltage of asynchronous motor 1	0~1200V	Depend on model	☉
P02.05	Rated current of asynchronous motor 1	0.8~6000.0A	Depend on model	☉
P02.06	Stator resistor of asynchronous motor 1	0.001~65.535Ω	Depend on model	○
P02.07	Rotor resistor of asynchronous motor 1	0.001~65.535Ω	Depend on model	○
P02.08	Leakage inductance of asynchronous motor 1	0.1~6553.5mH	Depend on model	○
P02.09	Mutual inductance	0.1~6553.5mH	Depend on	○

Function code	Name	Detailed instruction of parameters	Default value	Modify
	of asynchronous motor 1		model	
P02.10	Non-load current of asynchronous motor 1	0.1~6553.5A	Depend on model	○
P02.11	Magnetic saturation coefficient 1 for the iron core of AM1	0.0~100.0%	88.0%	◎
P02.12	Magnetic saturation coefficient 2 for the iron core of AM1	0.0~100.0%	81.0%	◎
P02.13	Magnetic saturation coefficient 3 for the iron core of AM1	0.0~100.0%	75.0%	◎
P02.14	Magnetic saturation coefficient 4 for the iron core of AM1	0.0~100.0%	50.0%	◎

Function code	Name	Detailed instruction of parameters	Default value	Modify
P02.15	Rated power of synchronous motor 1	0.1~3000.0kW	Depend on model	⊙
P02.16	Rated frequency of synchronous motor 1	0.01Hz~P00.03(the Max. frequency)	50.00 Hz	⊙
P02.17	Number of poles pairs for synchronous motor 1	1~128	2	⊙
P02.18	Rated voltage of synchronous motor 1	0~1200V	Depend on model	⊙
P02.19	Rated current of synchronous motor 1	0.8~6000.0A	Depend on model	⊙
P02.20	Stator resistor of synchronous motor 1	0.001~65.535Ω	Depend on model	○
P02.21	Direct axis inductance of synchronous motor 1	0.01~6553.5mH	Depend on model	○
P02.22	Quadrature axis inductance	0.01~655.35mH	Depend on model	○

Function code	Name	Detailed instruction of parameters	Default value	Modify
	of synchronous motor 1			
P02.23	Back EMF constant of synchronous motor 1	<p>When P00.15=2, the set value of P02.23 cannot be updated by autotuning, please count according to the following method.</p> <p>The counter-electromotive force constant can be counted according to the parameters on the name plate of the motor. There are three ways to count:</p> <p>1. If the name plate designate the counter-electromotive force constant K_e, then: $E = (K_e * n_N * 2 \pi) / 60$</p> <p>2. If the name plate designate the counter-electromotive force constant $E'(\text{V}/1000\text{r}/\text{min})$, then: $E = E' * n_N / 1000$</p> <p>3. If the name plate does not designate the above parameters, then: $E = P / \sqrt{3} * I$</p> <p>In the above formulas: n_N is the rated rotation speed, P is the rated power and I is the rated current.</p> <p>Setting range: 0~10000</p>	320	○
P02.24	Initial pole position of synchronous motor 1 (reserved)	0x0000~0xFFFF	0	●
P02.25	Identification current of synchronous motor 1 (reserved)	0%~50% (rated current of the motor)	10%	●

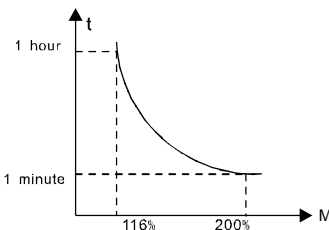
Function code	Name	Detailed instruction of parameters	Default value	Modify
P02.26	Motor 1 overload protection	<p>0:No protection</p> <p>1: Common motor (with low speed compensation). Because the heat-releasing effect of the common motors will be weakened, the corresponding electric heat protection will be adjusted properly. The low speed compensation characteristic mentioned here means reducing the threshold of the overload protection of the motor whose running frequency is below 30Hz.</p> <p>2: Variable frequency motor (without low speed compensation) Because the heat-releasing effect of the specific motors won't be impacted by the rotation speed, it is not necessary to adjust the protection value during low-speed running.</p>	2	⊙
P02.27	Motor 1 overload protection coefficient	<p>Times of motor overload $M = I_{out}/(I_n \cdot K)$</p> <p>$I_n$ is the rated current of the motor, I_{out} is the output current of the inverter and K is the motor protection coefficient.</p> <p>So, the bigger the value of K is, the smaller the value of M is. When $M = 116\%$, the fault will be reported after 1 hour, when $M = 200\%$, the fault will be reported after 1 minute, when $M \geq 400\%$, the fault will be reported instantly.</p>  <p>Setting range: 20.0%~120.0%</p>	100.0 %	○
P02.28	Reserved			○

Function code	Name	Detailed instruction of parameters	Default value	Modify
P02.29	Parameter display of motor 1	0: Display according to the motor type 1: Display all	0	●
P03 Group Vector control				
P03.00	Speed loop proportion al gain1	<p>The parameters P03.00~P03.05 only apply to vector control mode. Below the switching frequency 1(P03.02), the speed loop PI parameters are: P03.00 and P03.01. Above the switching frequency 2(P03.05), the speed loop PI parameters are: P03.03 and P03.04. PI parameters are gained according to the linear change of two groups of parameters. It is shown as below:</p>	16.0	○
P03.01	Speed loop integral time1		0.200s	○
P03.02	Low switching frequency		5.00 Hz	○
P03.03	Speed loop proportion al gain 2		10.0	○
P03.04	Speed loop integral time 2		0.200s	○
P03.05	High switching frequency	<p>Setting the proportional coefficient and integral time of the adjustor can change the dynamic response performance of vector control speed loop. Increasing the proportional gain and decreasing the integral time can speed up the dynamic response of the speed loop. But too high proportional gain and too low integral time may cause system vibration and overshoot. Too low proportional gain may cause system vibration and speed static deviation. PI has a close relationship with the inertia of the system. Adjust on the base of PI according to different loads to meet various demands.</p> <p>The setting range of P03.00: 0.0~200.0</p>	10.00 Hz	○

Function code	Name	Detailed instruction of parameters	Default value	Modify
		The setting range of P03.01: 0.000~10.000s The setting range of P03.02: 0.00Hz~P03.05 The setting range of P03.03: 0.0~200.0 The setting range of P03.04:0.000~10.000s The setting range of P03.05:P03.02~P00.03(the Max. output frequency)		
P03.06	Speed loop output filter	0~8 (corresponds to 0~2 ⁸ /10ms)	0	<input type="radio"/>
P03.07	Compensation coefficient of electromotion slip	Slip compensation coefficient is used to adjust the slip frequency of the vector control and improve the speed control accuracy of the system. Adjusting the parameter properly can control the speed steady-state error.	100%	<input type="radio"/>
P03.08	Compensation coefficient of braking slip	Setting range:50%~200%	100%	<input type="radio"/>
P03.09	Current loop percentage coefficient P	Note: 1 These two parameters adjust the PI adjustment parameter of the current loop which affects the dynamic response speed and control accuracy directly. Generally, users do not need to change the default value.	1000	<input type="radio"/>
P03.10	Current loop integral coefficient 1	2 Only apply to the vector control mode without PG 0(P00.00=0). Setting range: 0~20000	1000	<input type="radio"/>
P03.11	Torque setting	This parameter is used to enable the torque control mode, and set the torque.	0	<input type="radio"/>

Function code	Name	Detailed instruction of parameters	Default value	Modify
	method	0: Torque control is invalid 1: Keypad setting torque(P03.12) 2: Analog AI1 setting torque 3: Analog AI2 setting torque 4: Analog AI3 setting torque 5: Pulse frequency HDI setting torque 6: Multi-step torque setting 7: MODBUS communication setting torque 8: PROFIBUS\CANopen communication setting torque 9: Ethernet communication setting torque 10: Reserved Note: Setting modes 2~10, 100% corresponds to three times of the rated current of the motor.		
P03.12	Keypad setting torque	Setting range: -300.0%~300.0%(rated current of the motor)	10.0%	○
P03.13	Torque reference filter time	0.000~10.000s	0.100s	○
P03.14	Upper frequency of forward rotation in vector control	0: Keypad (P03.16 sets P03.14,P03.17 sets P03.15) 1: AI1 2: AI2 3: AI3 4: Pulse frequency HDI setting upper-limit frequency	0	○
P03.15	Upper frequency of reverse rotation in vector control	5: Multi-step setting upper-limit frequency 6: MODBUS communication setting upper-limit frequency 7: PROFIBUS/CANopen communication setting upper-limit frequency 8: Ethernet communication setting upper-limit frequency Note: Setting method 1~8, 100% corresponds to the	0	○

Function code	Name	Detailed instruction of parameters	Default value	Modify
		maximum frequency		
P03.16	Keypad setting for upper frequency of forward rotation	This function is used to set the upper limit of the of forward frequency. P03.16 determines the setting when P03.14=1; P03.17 determines the setting when P03.15=1.	50.00 Hz	<input type="radio"/>
P03.17	Keypad setting for upper frequency of reverse rotation	Setting range:0.00 Hz~P00.03 (the Max. output frequency)	50.00 Hz	<input type="radio"/>
P03.18	Upper electromotion torque source	This function code is used to select the electromotion and braking torque upper-limit setting source selection. 0:Keypad setting upper-limit frequency(P03.20 sets P03.18, P03.21 sets P03.19)	0	<input type="radio"/>
P03.19	Upper braking torque source	1: AI1 2: AI2 3: AI3 4: HDI 5:MODBUS communication 6:PROFIBUS/CANopen communication 7:Ethernet communication Note: setting mode 1~7,100% corresponds to three times of the motor current.	0	<input type="radio"/>
P03.20	Keypad setting of electromotion	The function code is used to set the limit of the torque. Setting range:0.0~300.0%(motor rated current)	180.0 %	<input type="radio"/>

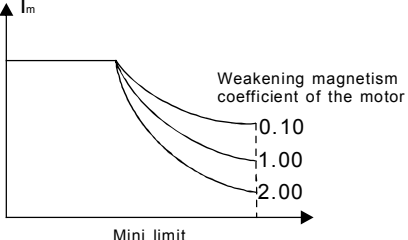
Function code	Name	Detailed instruction of parameters	Default value	Modify
	torque			
P03.21	Keypad setting of braking torque		180.0 %	<input type="radio"/>
P03.22	Weakening coefficient in constant power zone	<p>The usage of motor in weakening control.</p> 	1.00	<input type="radio"/>
P03.23	Lowest weakening point in constant power zone	<p>Function code P03.22 and P03.23 are effective at constant power. The motor will enter into the weakening state when the motor runs at rated speed. Change the weakening curve by modifying the weakening control coefficient. The bigger the weakening control coefficient is, the steeper the weak curve is.</p> <p>The setting range of P03.22: 0.10~2.00 The setting range of P03.23: 5%~50%</p>	20%	<input type="radio"/>
P03.24	Max. voltage limit	<p>P03.24 set the Max. Voltage of the inverter, which is dependent on the site situation.</p> <p>The setting range:0.0~120.0%</p>	100.0 %	<input checked="" type="radio"/>
P03.25	Pre-exciting time	<p>Preactivate the motor when the inverter starts up. Build up a magnetic field inside the inverter to improve the torque performance during the starting process.</p> <p>The setting time:0.000~10.000s</p>	0.000s	<input type="radio"/>
P03.26	Weak proportion	<p>0~8000</p> <p>Note: P03.24~P03.26 are invalid for vector mode.</p>	1200	<input type="radio"/>

Function code	Name	Detailed instruction of parameters	Default value	Modify
	al gain			
P03.27	Integral gain of the weak magnetic	The response is relative to P03.26 and P03.27. It can be adjusted. Setting range: 0~8000	1200	○
P03.28	Control mode of the weak magnetic	0x000~0x112 Ones: Control mode selection 0: Mode 0 1: Mode 1 2: Mode 2 Tens: Inducence compensation selection 0: Compensate 1: Not compensate Hundreds: High speed control mode 0: Mode 0 1: Mode 1	0x000	○
P03.29	Torque control mode	0x0000~0x7111 Ones: Torque command seelction 0: Torque reference 1: Torque current reference Tens: Torque compensation direction at 0 speed 0: Positive 1: Negative Hundreds: speed loop integral seperation 0: Disabled 1: Enabled Thousands: Torque command filter Bit0: Filter mode 0: Inertis filter 1: Linear ACC/DEC filter Bit1~2: ACC/DEC time 0: No ACC/DEC time 1: ACC/DEC time 1 2: ACC/DEC time 2 3: ACC/DEC time 3	0x0001	○

Function code	Name	Detailed instruction of parameters	Default value	Modify
P03.30	Low-speed friction torque	P03.30 is the compensation value of low-speed (<1.0Hz) friction torque.	0.0%	○
P03.31	High-speed friction torque	P03.31 is the compensation value of high-speed (>P03.32) friction torque. The friction torque between low and high speed is the liner scale of	0.0%	○
P03.32	Corresponding frequency of high-speed friction torque	P03.30 and P03.31. Torque compensation is valid in the torque control mode (P03.11≠0). Setting range of P03.30:0.0~50.0% Setting range of P03.31:0.0~50.0% Setting range of P03.32:1.00 Hz~400.00Hz	50.00Hz	○
P04 Group SVPWM control				
P04.00	Motor 1V/F curve setting	These function codes define the V/F curve of Goodrive35 motor 1 to meet the need of different loads. 0: Straight line V/F curve; applying to the constant torque load 1: Multi-dots V/F curve 2: 1.3 th power low torque V/F curve 3: 1.7 th power low torque V/F curve 4: 2.0 th power low torque V/F curve Curves 2~4 apply to the torque loads such as fans and water pumps. Users can adjust according to the features of the loads to achieve a best energy-consuming effect. 5: Customized V/F(V/F separation); on this mode, V and F can be separated from f and f can be adjusted through the frequency given channel set by P00.06 or the voltage given channel set by P04.27 to change the feature of the curve.	0	◎

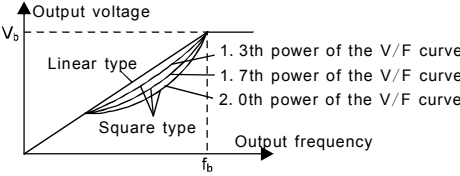
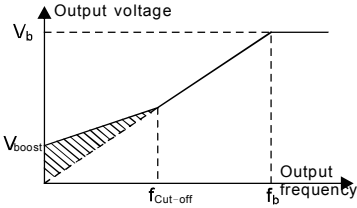
Function code	Name	Detailed instruction of parameters	Default value	Modify
		<p>Note: V_b in the below picture is the motor rated voltage and f_b is the motor rated frequency.</p> 		
P04.01	Torque boost of motor 1	Torque boost to the output voltage for the features of low frequency torque. P04.01 is for the Max. Output voltage V_b .	0.0%	○
P04.02	Torque boost close of motor 1	<p>P04.02 defines the percentage of closing frequency of manual torque to f_b.</p> <p>Torque boost should be selected according to the load. The bigger the load is, the bigger the boost is.</p> <p>Too big torque boost is inappropriate because the motor will run with over-magnetic, and the current of the inverter will increase to raise the temperature of the inverter and decrease the efficiency.</p> <p>When the torque boost is set to 0.0%, the inverter is automatic torque boost.</p> <p>Torque boost threshold: under the threshold, the torque boost is valid, but over the threshold, the torque boost is invalid.</p> 	20.0%	○

Function code	Name	Detailed instruction of parameters	Default value	Modify	
		The setting range of P04.01:0.0%:(automatic)0.1%~10.0% The setting range of P04.02:0.0%~50.0%			
P04.03	V/F frequency 1 of motor 1		0.00 Hz	<input type="radio"/>	
P04.04	V/F voltage 1 of motor 1		0.0%	<input type="radio"/>	
P04.05	V/F frequency 2 of motor 1		When P04.00 =1, the user can set V/F curve through P04.03~P04.08. V/F is generally set according to the load of the motor.	0.00 Hz	<input type="radio"/>
P04.06	V/F voltage 2 of motor 1		Note: $V1 < V2 < V3, f1 < f2 < f3$. Too high low frequency voltage will heat the motor excessively or cause damage. The inverter may stall when overcurrent or overcurrent protection.	0.0%	<input type="radio"/>
P04.07	V/F frequency 3 of motor 1	The setting range of P04.03: 0.00Hz~P04.05 The setting range of P04.04:0.0%~110.0% The setting range of P04.05:P04.03~ P04.07	0.00 Hz	<input type="radio"/>	
P04.08	V/F voltage 3 of motor 1	The setting range of P04.06:0.0%~110.0%(the rated voltage of motor 1) The setting range of P04.07:P04.05~ P02.02(the rated frequency of motor 1) or P04.05~ P02.16(the rated frequency of motor 1) The setting range of P04.08:0.0%~110.0%(the rated voltage of motor 1)	0.0%	<input type="radio"/>	
P04.09	V/F slip compensation gain of motor 1	This function code is used to compensate the change of the rotation speed caused by load during compensation SVPWM control to improve the rigidity of the motor. It can be set to the rated slip frequency	100.0 %	<input type="radio"/>	

Function code	Name	Detailed instruction of parameters	Default value	Modify
		of the motor which is counted as below: $\Delta f = f_b - n * p / 60$ Of which, f_b is the rated frequency of the motor, its function code is P02.01; n is the rated rotating speed of the motor and its function code is P02.02; p is the pole pair of the motor. 100.0% corresponds to the rated slip frequency Δf . Setting range: 0.0~200.0%		
P04.10	Vibration control factor at low frequency of motor 1	In SVPWM control mode, current fluctuation may occur to the motor at some frequency, especially the motor with big power. The motor can not run stably or overcurrent may occur. These phenomena can be canceled by adjusting this parameter. The setting range of P04.10: 0~100 The setting range of P04.11: 0~100 The setting range of P04.12: 0.00Hz~P00.03 (the Max. frequency)	10	○
P04.11	Vibration control factor at high frequency of motor 1		10	○
P04.12	Vibration control threshold of motor 1		30.00 Hz	○
P04.13	Motor 2 V/F curve setting	This group of parameters defines the V/F setting means of Goodrive35 motor 2 to meet various requirements of different loads. See P04.00~P04.12 for the detailed function code instruction.	0	◎
P04.14	Torque boost of motor 2	Note: P04 group includes two sets of V/F parameters of the motor which cannot display simultaneously.	0.0%	○
P04.15	Torque boost close of motor 2	Only the selected V/F parameter can be shown. The motor selection can be defined by terminals function "the shift between motor 1 and motor 2"	20.0%	○

Function code	Name	Detailed instruction of parameters	Default value	Modify
P04.16	V/F frequency 1 of motor 2		0.00 Hz	<input type="radio"/>
P04.17	V/F voltage 1 of motor 2		0.0%	<input type="radio"/>
P04.18	V/F frequency 2 of motor 2		0.00Hz	<input type="radio"/>
P04.19	V/F voltage 2 of motor 2		0.0%	<input type="radio"/>
P04.20	V/F frequency 3 of motor 2		0.00 Hz	<input type="radio"/>
P04.21	V/F voltage 3 of motor 2		0.0%	<input type="radio"/>
P04.22	V/F slip compensation gain of motor 2		100.0 %	<input type="radio"/>
P04.23	Vibration control factor at low frequency of motor 2		In SVPWM control mode, current fluctuation may occur to the motor on some frequency, especially the motor with big power. The motor can not run stably or overcurrent may occur. These phenomena can be canceled by adjusting this parameter. The setting range of P04.23:0~100	10
P04.24	Vibration control	The setting range of P04.24:0~100 The setting range of P04.25:0.00Hz~P00.03	10	<input type="radio"/>

Function code	Name	Detailed instruction of parameters	Default value	Modify
	factor at high frequency of motor 2	(the Max. frequency)		
P04.25	Vibration control threshold of motor 2		30.00 Hz	<input type="radio"/>
P04.26	Energy-saving operation	0:No operation 1:Automatic energy-saving operation (reserved) Motors will automatically adjust the output voltage to save energy when light loads.	0	<input checked="" type="radio"/>
P04.27	Voltage setting	Select the output setting channel at V/F curve separation. 0: Keypad: the output voltage is determined by P04.28. 1:A11 ; 2:A12; 3:A13; 4:HD11; 5:Multi-step speed; 6:PID; 7:MODBUS communication; 8:PROFIBUS/CANopen communication; 9:Ethernet communication; 10: Reserved Note: 100% corresponds to the rated voltage of the motor.	0	<input type="radio"/>
P04.28	Keypad setting voltage	The function code is the voltage displaying when the voltage is set through keypad. The setting range:0.0%~100.0%	100.0 %	<input type="radio"/>
P04.29	Voltage increasing time	Voltage increasing time is the time when the inverter accelerates from the output minimum voltage to the output maximum voltage.	5.0s	<input type="radio"/>

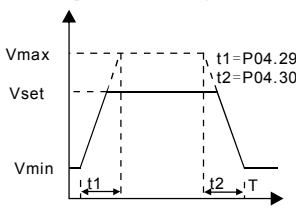
Function code	Name	Detailed instruction of parameters	Default value	Modify
P04.30	Voltage decreasing time	Voltage decreasing time is the time when the inverter decelerates from the output maximum voltage to the output minimum voltage. The setting range:0.0~3600.0s	5.0s	<input type="radio"/>
P04.31	Maximum output voltage	Set the upper and low limit of the output voltage. The setting range of P04.31:P04.32~100.0% (the rated voltage of the motor)	100.0 %	<input checked="" type="radio"/>
P04.32	Minimum output voltage	The setting range of P04.32:0.0%~ P04.31 (the rated voltage of the motor) 	0.0%	<input checked="" type="radio"/>
P05 Group Input terminals				
P05.00	HDI input selection	0: High pulse input. See P05.49~P05.54 1: Digital input. See P05.09	0	<input checked="" type="radio"/>
P05.01	S1 terminals function selection	0: No function 1: Forward rotation operation 2: Reverse rotation operation 3: 3-wire control operation	1	<input checked="" type="radio"/>
P05.02	S2 terminals function selection	4: Forward jogging 5: Reverse jogging 6: Coast to stop 7: Fault reset	4	<input checked="" type="radio"/>
P05.03	S3 terminals function selection	8: Operation pause 9: External fault input 10:Increasing frequency setting(UP) 11:Decreasing frequency setting(DOWN)	7	<input checked="" type="radio"/>
P05.04	S4 terminals function selection	12:Frequency setting clear 13:Shift between A setting and B setting 14:Shift between combination setting and A setting 15:Shift between combination setting and B setting	0	<input checked="" type="radio"/>

Function code	Name	Detailed instruction of parameters	Default value	Modify
P05.05	S5 terminals function selection	16:Multi-step speed terminal 1 17:Multi-step speed terminal 2 18:Multi-step speed terminal 3 19:Multi- step speed terminal 4	0	☉
P05.06	S6 terminals function selection	20:Multi- step speed pause 21:ACC/DEC time 1 22:ACC/DEC time 2 23:Simple PLC stop reset	0	☉
P05.07	S7 terminals function selection	24:Simple PLC pause 25:PID control pause 26: Forward rotation limit 27: Reverse rotation limit	0	☉
P05.08	S8 terminals function selection	28: Counting clear 29:Torque control disabling 30:ACC/DEC disabling 31:Counter triggering	0	☉
P05.09	HDI terminal function selection	32:Length reset 33:Cancel the frequency change setting temporarily 34:DC brake 35:Shift the motor 1 into motor 2 36:Shift the command to the keypad 37:Shift the command to the terminals 38:Shift the command to the communication 39:Pre-magnetized command 40:Consumption power clear 41: Consumption power holding 42: Keypad setting of the torque upper limit 43: Position reference input (only S8 valid) 44: Spindle direction prohibit 45: Spindle returning /Local position returning 46: Zero position selection 1 47: Zero position selection 2 48: Spindle scaling selection 1 49: Spindle scaling selection 2	0	☉

Function code	Name	Detailed instruction of parameters	Default value	Modify																				
		50: Spindle scaling selection 3 51: Switching terminal of position control and speed control 52: Pulse input disabled 53: Position deviation clear 54: Position proportional gain switch 55: Digital position cycle positioning enabled 56: E-stop 57: Motor overtemperature fault input 58: Rigid tapping enable 59: Switch to SVPWMcontrol 60: Switch to FVC control 61:PID pole switching 62: Undervoltage stopping input 63: Reserved																						
P05.10	Polarity selection of the input terminals	The function code is used to set the polarity of the input terminals. Set the bit to 0, the input terminal is anode. Set the bit to 1, the input terminal is cathode. <table border="1" style="margin-left: 20px;"> <tr> <td></td> <td>BIT8</td> <td>BIT7</td> <td>BIT6</td> <td>BIT5</td> </tr> <tr> <td></td> <td>HDI</td> <td>S8</td> <td>S7</td> <td>S6</td> </tr> <tr> <td>BIT4</td> <td>BIT3</td> <td>BIT2</td> <td>BIT1</td> <td>BIT0</td> </tr> <tr> <td>S5</td> <td>S4</td> <td>S3</td> <td>S2</td> <td>S1</td> </tr> </table> The setting range:0x000~0x1FF		BIT8	BIT7	BIT6	BIT5		HDI	S8	S7	S6	BIT4	BIT3	BIT2	BIT1	BIT0	S5	S4	S3	S2	S1	0x000	○
	BIT8	BIT7	BIT6	BIT5																				
	HDI	S8	S7	S6																				
BIT4	BIT3	BIT2	BIT1	BIT0																				
S5	S4	S3	S2	S1																				
P05.11	ON-OFF filter time	Set the sample filter time of S1~S8 and HDI terminals. If the interference is strong, increase the parameter to avoid the disoperation. 0.000~1.000s	0.010s	○																				
P05.12	Virtual terminals setting	0x000~0x1FF(0: Disabled, 1:Enabled) BIT0:S1 virtual terminal BIT1:S2 virtual terminal BIT2:S3 virtual terminal BIT3:S4 virtual terminal BIT4:S5 virtual terminal	0x000	◎																				

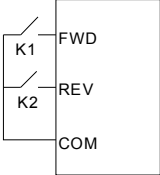
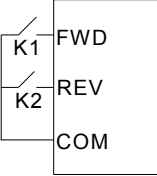
Function code	Name	Detailed instruction of parameters	Default value	Modify																														
		BIT5:S6 virtual terminal BIT6:S7 virtual terminal BIT7:S8 virtual terminal BIT8:HDI virtual terminal																																
P05.13	Terminals control running mode	<p>Set the operation mode of the terminals control</p> <p>0:2-wire control 1, comply the enable with the direction. This mode is widely used. It determines the rotation direction by the defined FWD and REV terminals command.</p> <div style="display: flex; align-items: center; justify-content: center;">  <table border="1" style="margin-left: 20px;"> <thead> <tr> <th>K1</th> <th>K2</th> <th>Running command</th> </tr> </thead> <tbody> <tr> <td>OFF</td> <td>OFF</td> <td>Stopping</td> </tr> <tr> <td>ON</td> <td>OFF</td> <td>Forward running</td> </tr> <tr> <td>OFF</td> <td>ON</td> <td>Reverse running</td> </tr> <tr> <td>ON</td> <td>ON</td> <td>Hold on</td> </tr> </tbody> </table> </div> <p>1:2-wire control 2; Separate the enable from the direction. FWD defined by this mode is the enabling ones. The direction depends on the state of the defined REV.</p> <div style="display: flex; align-items: center; justify-content: center;">  <table border="1" style="margin-left: 20px;"> <thead> <tr> <th>K1</th> <th>K2</th> <th>Running command</th> </tr> </thead> <tbody> <tr> <td>OFF</td> <td>OFF</td> <td>Stopping</td> </tr> <tr> <td>ON</td> <td>OFF</td> <td>Forward running</td> </tr> <tr> <td>OFF</td> <td>ON</td> <td>Hold on</td> </tr> <tr> <td>ON</td> <td>ON</td> <td>Reverse running</td> </tr> </tbody> </table> </div> <p>2:3-wire control 1; Sin is the enabling terminal on this mode, and the running command is caused by FWD and the direction is controlled by REV. Sin is natural closed.</p>	K1	K2	Running command	OFF	OFF	Stopping	ON	OFF	Forward running	OFF	ON	Reverse running	ON	ON	Hold on	K1	K2	Running command	OFF	OFF	Stopping	ON	OFF	Forward running	OFF	ON	Hold on	ON	ON	Reverse running	0	©
K1	K2	Running command																																
OFF	OFF	Stopping																																
ON	OFF	Forward running																																
OFF	ON	Reverse running																																
ON	ON	Hold on																																
K1	K2	Running command																																
OFF	OFF	Stopping																																
ON	OFF	Forward running																																
OFF	ON	Hold on																																
ON	ON	Reverse running																																

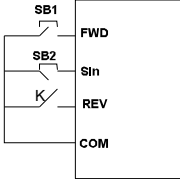
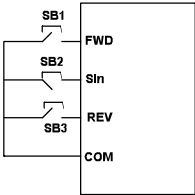
Function code	Name	Detailed instruction of parameters	Default value	Modify																																											
		 <p>The direction control is as below during operation:</p> <table border="1"> <thead> <tr> <th>SIn</th> <th>REV</th> <th>Previous direction</th> <th>Current direction</th> </tr> </thead> <tbody> <tr> <td rowspan="2">ON</td> <td rowspan="2">OFF→ON</td> <td>Forward</td> <td>Reverse</td> </tr> <tr> <td>Reverse</td> <td>Forward</td> </tr> <tr> <td rowspan="2">ON</td> <td rowspan="2">ON→OFF</td> <td>Reverse</td> <td>Forward</td> </tr> <tr> <td>Forward</td> <td>Reverse</td> </tr> <tr> <td rowspan="2">ON→OFF</td> <td>ON</td> <td colspan="2" rowspan="2">Decelerate to stop</td> </tr> <tr> <td>OFF</td> </tr> </tbody> </table> <p>3:3-wire control 2; Sin is the enabling terminal on this mode, and the running command is caused by SB1 or SB3 and both of them control the running direction. NC SB2 generates the stop command.</p>  <table border="1"> <thead> <tr> <th>SIn</th> <th>FWD</th> <th>REV</th> <th>Direction</th> </tr> </thead> <tbody> <tr> <td rowspan="2">ON</td> <td>OFF→O</td> <td>ON</td> <td>Forward</td> </tr> <tr> <td>N</td> <td>OFF</td> <td>Reverse</td> </tr> <tr> <td rowspan="2">ON</td> <td>ON</td> <td>OFF→O</td> <td>Forward</td> </tr> <tr> <td>OFF</td> <td>N</td> <td>Reverse</td> </tr> <tr> <td>ON→OFF</td> <td></td> <td></td> <td>Decelerate</td> </tr> </tbody> </table>	SIn	REV	Previous direction	Current direction	ON	OFF→ON	Forward	Reverse	Reverse	Forward	ON	ON→OFF	Reverse	Forward	Forward	Reverse	ON→OFF	ON	Decelerate to stop		OFF	SIn	FWD	REV	Direction	ON	OFF→O	ON	Forward	N	OFF	Reverse	ON	ON	OFF→O	Forward	OFF	N	Reverse	ON→OFF			Decelerate		
SIn	REV	Previous direction	Current direction																																												
ON	OFF→ON	Forward	Reverse																																												
		Reverse	Forward																																												
ON	ON→OFF	Reverse	Forward																																												
		Forward	Reverse																																												
ON→OFF	ON	Decelerate to stop																																													
	OFF																																														
SIn	FWD	REV	Direction																																												
ON	OFF→O	ON	Forward																																												
	N	OFF	Reverse																																												
ON	ON	OFF→O	Forward																																												
	OFF	N	Reverse																																												
ON→OFF			Decelerate																																												

Function code	Name	Detailed instruction of parameters	Default value	Modify
P05.21	Switch-off delay of S4 terminal	Setting range:0.000~50.000s	0.000s	<input type="radio"/>
P05.22	Switch-on delay of S5 terminal		0.000s	<input type="radio"/>
P05.23	Switch-off delay of S5 terminal		0.000s	<input type="radio"/>
P05.24	Switch-on delay of S6 terminal		0.000s	<input type="radio"/>
P05.25	Switch-off delay of S6 terminal		0.000s	<input type="radio"/>
P05.26	Switch-on delay of S7 terminal		0.000s	<input type="radio"/>
P05.27	Switch-off delay of S7 terminal		0.000s	<input type="radio"/>
P05.28	Switch-on delay of S8 terminal		0.000s	<input type="radio"/>
P05.29	Switch-off delay of S8 terminal		0.000s	<input type="radio"/>
P05.30	Switch-on delay of HDI terminal		0.000s	<input type="radio"/>

Function code	Name	Detailed instruction of parameters	Default value	Modify				
		<table border="1" style="width: 100%; border-collapse: collapse;"> <tr> <td style="width: 25%;"></td> <td style="width: 25%;"></td> <td style="width: 25%;"></td> <td style="width: 25%; text-align: right;">to stop</td> </tr> </table> <p>Note: for the 2-wire running mode, when FWD/REV terminal is valid, the inverter stop because of the stopping command from other sources, even the control terminal FWD/REV keeps valid; the inverter won't work when the stopping command is canceled. Only when FWD/REV is relaunched, the inverter can start again. For example, the valid STOP/RST stop when PLC signal cycles stop, fixed-length stop and terminal control (see P07.04).</p>				to stop		
			to stop					
P05.14	Switch-on delay of S1 terminal	The function code defines the corresponding delay time of electrical level of the programmable terminals from switching on to switching off.	0.000s	○				
P05.15	Switch-off delay of S1 terminal	<p>Note: P05.30 and P05.31 are valid when P05.00=1.</p>	0.000s	○				
P05.16	Switch-on delay of S2 terminal		0.000s	○				
P05.17	Switch-off delay of S2 terminal		0.000s	○				
P05.18	Switch-on delay of S3 terminal		0.000s	○				
P05.19	Switch-off delay of S3 terminal		0.000s	○				
P05.20	Switch-on delay of S4 terminal		0.000s	○				

Function code	Name	Detailed instruction of parameters	Default value	Modify	
P05.31	Switch-off delay of HDI terminal		0.000s	<input type="radio"/>	
P05.32	Lower limit of AI1	The function code defines the relationship between the analog input voltage and its corresponding set value. If the analog input voltage beyond the set minimum or maximum input value, the inverter will count at the minimum or maximum one.	0.00V	<input type="radio"/>	
P05.33	Corresponding setting of the lower limit of AI1	When the analog input is the current input, the corresponding voltage of 0~20mA is 0~10V.	0.0%	<input type="radio"/>	
P05.34	Upper limit of AI1	In different cases, the corresponding rated value of 100.0% is different. See the application for detailed information.	10.00 V	<input type="radio"/>	
P05.35	Corresponding setting of the upper limit of AI1	The figure below illustrates different applications:	100.0 %	<input type="radio"/>	
P05.36	AI1 input filter time		0.030s	<input type="radio"/>	
P05.37	Lower limit of AI2			0.00V	<input type="radio"/>
P05.38	Corresponding setting of the lower limit of AI2		Input filter time: this parameter is used to adjust the sensitivity of the analog input. Increasing the value properly can enhance the anti-interference of the analog, but weaken the sensitivity of the analog input.	0.0%	<input type="radio"/>
P05.39	Upper limit of AI2	Note: Analog AI1 and AI2 can support 0~10V or 0~20mA input, when AI1 and AI2 selects 0~20mA	10.00 V	<input type="radio"/>	
P05.40	Corresponding	input, the corresponding voltage of 20mA is 5V. AI3 can support the output of -10V~+10V.	100.0 %	<input type="radio"/>	

Function code	Name	Detailed instruction of parameters	Default value	Modify
	setting of the upper limit of AI2	The setting range of P05.32:0.00V~P05.34 The setting range of P05.33: -300.0%~300.0% The setting range of P05.34:P05.32~10.00V		
P05.41	AI2 input filter time	The setting range of P05.35: -300.0%~300.0% The setting range of P05.36:0.000s~10.000s	0.100s	○
P05.42	Lower limit of AI3	The setting range of P05.37:0.00V~P05.39 The setting range of P05.38: -300.0%~300.0% The setting range of P05.39:P05.37~10.00V	-10.00 V	○
P05.43	Corresponding setting of the lower limit of AI3	The setting range of P05.40: -300.0%~300.0% The setting range of P05.41:0.000s~10.000s The setting range of P05.42:-10.00V~P05.44 The setting range of P05.43: -300.0%~300.0% The setting range of P05.44:P05.42~P05.46	-100.0 %	○
P05.44	Middle value of AI3	The setting range of P05.45:-100.0%~100.0% The setting range of P05.46:P05.44~10.00V The setting range of P05.47: -300.0%~300.0%	0.00V	○
P05.45	Corresponding middle setting of AI3	The setting range of P05.48:0.000s~10.000s	0.0%	○
P05.46	Upper limit of AI3		10.00 V	○
P05.47	Corresponding setting of the upper limit of AI3		100.0 %	○
P05.48	AI3 input filter time		0.030s	○
P05.49	HDI	The function selection when HDI terminals is	0	◎

Function code	Name	Detailed instruction of parameters	Default value	Modify
	high-speed pulse input function selection	high-speed pulse input 0: Frequency setting input, frequency setting source 1~2: Reserved		
P05.50	Lower limit frequency of HDI	0.000 kHz~P05.52	0.000 kHz	○
P05.51	Corresponding setting of HDI low frequency setting	300.0%~300.0%	0.0%	○
P05.52	Upper limit frequency of HDI	P05.50 ~50.000kHz	50.000 kHz	○
P05.53	Corresponding setting of upper limit frequency of HDI	300.0%~300.0%	100.0 %	○
P05.54	HDI frequency input filter time	0.000s~10.000s	0.030s	○
P06 Group Output terminals				
P06.00	HDO output	The function selection of the high-speed pulse output terminals. 0: Open collector pole high speed pulse output: The Max.pulse frequency is 50.0kHz. See	0	◎

Function code	Name	Detailed instruction of parameters	Default value	Modify
		P06.27~P06.31 for detailed information of the related functions. 1: Open collector pole output. See P06.02 for detailed information of the related functions.		
P06.01	Y output	0:Invalid	0	○
P06.02	HDO output	1:In operation 2:Forward rotation operation	0	○
P06.03	Relay RO1 output	3:Reverse rotation operation 4: Jogging operation	1	○
P06.04	Relay RO2 output	5:The inverter fault 6:Frequency degree test FDT1 7:Frequency degree test FDT2 8:Frequency arrival 9:Zero speed running 10:Upper limit frequency arrival 11:Lower limit frequency arrival 12:Ready for operation 13:Pre-magnetizing 14:Overload pre-alarm 15: Underload pre-alarm 16:Completion of simple PLC stage 17:Completion of simple PLC cycle 18:Setting count value arrival 19:Defined count value arrival 20:External fault valid 21:Length arrival 22:Running time arrival 23:MODBUS communication virtual terminals output 24:PROFIBUS/CANopen communication virtual terminals output 25: Ethernet communication virtual terminals output 26:DC bus voltage established	5	○

Function code	Name	Detailed instruction of parameters	Default value	Modify								
		27~29: Reserved 30: Positioning finished 31: Zero returning 32: Spindle scaling 33: Speed limiting 34: Low bus voltage 35: Undervoltage stopping output 36~40: Reserved										
P06.05	Polarity of output terminals	The function code is used to set the pole of the output terminal. When the current bit is set to 0, input terminal is positive. When the current bit is set to 1, input terminal is negative.	0x0	○								
		<table border="1" style="width: 100%; text-align: center;"> <tr> <td>BIT0</td> <td>BIT1</td> <td>BIT2</td> <td>BIT3</td> </tr> <tr> <td>Y</td> <td>HDO</td> <td>RO1</td> <td>RO2</td> </tr> </table> Setting range: 0x0~0xF	BIT0	BIT1	BIT2	BIT3	Y	HDO	RO1	RO2		
BIT0	BIT1	BIT2	BIT3									
Y	HDO	RO1	RO2									
P06.06	Y switch-on delay time	The function code defines the corresponding delay time of the electrical level change during the programmable terminal switching on and off.	0.000s	○								
P06.07	Y switch-off delay time		0.000s	○								
P06.08	HDO switch-on delay time		0.000s	○								
P06.09	HDO switch-off delay time		0.000s	○								
P06.10	RO1 switch-on delay time		0.000s	○								
			The setting range :0.000~50.000s									

Function code	Name	Detailed instruction of parameters	Default value	Modify
P06.11	RO1 switch-off delay time	Note: P06.08 and P06.08 are valid only when P06.00=1.	0.000s	<input type="radio"/>
P06.12	RO2 switch-on delay time		0.000s	<input type="radio"/>
P06.13	RO2 switch-off delay time		0.000s	<input type="radio"/>
P06.14	AO1 output	0:Running frequency 1:Set frequency	0	<input type="radio"/>
P06.15	AO2 output	2:Ramp reference frequency 3:Running rotation speed	0	<input type="radio"/>
P06.16	HDO high-speed pulse output	4:Output current (relative to the rated current of the inverter) 5:Output current(relative to the rated current of the motor) 6:Output voltage 7:Output power 8:Set torque value 9:Output torque 10:Analog AI1 input value 11:Analog AI2 input value 12:Analog AI3 input value 13:High speed pulse HDI input value 14:MODBUS communication set value 1 15:MODBUS communication set value 2 16:PROFIBUS/CANopen communication set value 1 17:PROFIBUS/CANopen communication set value 2 18: Ethernet communication set value 1 19: Ethernet communication set value 2 20~21: Reserved	0	<input type="radio"/>

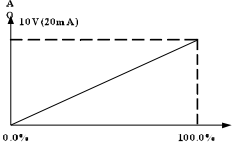
Function code	Name	Detailed instruction of parameters	Default value	Modify
		22: Torque current (relative to the rated current of the motor) 23: Pre-magnetizing current (relative to the rated current of the motor) 24: Setting frequency 25: Ramp reference frequency 26: Operation speed 27: Reserved		
P06.17	Lower output limit of AO1	The above function codes define the relative relationship between the output value and analog output. When the output value exceeds the range of	0.0%	<input type="radio"/>
P06.18	Corresponding AO1 output of lower limit	set maximum or minimum output, it will count according to the low-limit or upper-limit output. When the analog output is current output, 1mA equals to 0.5V.	0.00V	<input type="radio"/>
P06.19	Upper output limit of AO1	In different cases, the corresponding analog output of 100% of the output value is different. See each application for detailed information.	100.0%	<input type="radio"/>
P06.20	The corresponding AO1 output of upper limit	 <p>Setting range of P06.17: -300.0%~P06.19 Setting range of P06.18: 0.00V~10.00V</p>	10.00V	<input type="radio"/>
P06.21	AO1 output filter time	Setting range of P06.19: P06.17~300.0% Setting range of P06.20: 0.00V~10.00V Setting range of P06.21: 0.000s~10.000s	0.000s	<input type="radio"/>
P06.22	Lower output limit of AO2	Setting range of P06.22: -300.0%~P06.24 Setting range of P06.23: 0.00V~10.00V Setting range of P06.24: P06.22~300.0%	0.0%	<input type="radio"/>
P06.23	Corresponding AO2	Setting range of P06.25: 0.00V~10.00V Setting range of P06.26: 0.000s~10.000s	0.00V	<input type="radio"/>

Function code	Name	Detailed instruction of parameters	Default value	Modify
	output of lower limit	Setting range of P06.27: -300.0%~P06.29 Setting range of P06.28:0.00~50.00kHz		
P06.24	Upper output limit of AO2	Setting range of P06.29: P06.27~300.0% Setting range of P06.30:0.00~50.00kHz Setting range of P06.31:0.000s~10.000s	100.0 %	<input type="radio"/>
P06.25	The corresponding AO2 output of upper limit		10.00 V	<input type="radio"/>
P06.26	AO2 output filter time		0.000s	<input type="radio"/>
P06.27	Lower output limit of HDO		0.00%	<input type="radio"/>
P06.28	Corresponding HDO output of lower limit		0.0kHz	<input type="radio"/>
P06.29	Upper output limit of HDO		100.0 %	<input type="radio"/>
P06.30	Corresponding HDO output of upper limit		50.00k Hz	<input type="radio"/>
P06.31	HDO output filter time		0.000s	<input type="radio"/>
P07 Group Human-Machine Interface				

Function code	Name	Detailed instruction of parameters	Default value	Modify
P07.00	User's password	<p>0~65535</p> <p>The password protection will be valid when setting any non-zero number.</p> <p>00000: Clear the previous user's password, and make the password protection invalid.</p> <p>After the set user's password becomes valid, if the password is incorrect, users cannot enter the parameter menu. Only correct password can make the user check or modify the parameters. Please remember all users' passwords.</p> <p>Retreat editing state of the function codes and the password protection will become valid in minute. If the valid password is available, press PRG/ESC to enter into the editing state of the function codes, and then "0.0.0.0.0" will be displayed. Unless input right password, the operator can not enter into it.</p> <p>Note: restoring to the default value can clear the password, please use it with caution.</p>	0	○
P07.01	Parameter copy	<p>The function code determines the manner of parameters copy.</p> <p>0:No operation</p> <p>1:Upload the local function parameter to the keypad</p> <p>2:Download the keypad function parameter to local address(including the motor parameters)</p> <p>3:Download the keypad function parameter to local address (excluding the motor parameter of P02 and P12 group)</p> <p>4:Download the keypad function parameters to local address (only for the motor parameter of P02 and P12 group)</p> <p>Note: After completing the 1~4 operations, the parameter will come back to 0 automatically; the</p>	0	◎

Function code	Name	Detailed instruction of parameters	Default value	Modify
		function of upload and download excludes the factory parameters of P29.		
P07.02	<p>QUICK/JO</p> <p>function selection</p>	<p>0: No function</p> <p>1: Jogging. Press QUICK/JOG to begin the jogging running.</p> <p>2: Shift the display state by the shifting key. Press QUICK/JOG to shift the displayed function code from right to left.</p> <p>3: Shift between forward rotations and reverse rotations. Press QUICK/JOG to shift the direction of the frequency commands. This function is only valid in the keypad commands channels.</p> <p>4: Clear UP/DOWN settings. Press QUICK/JOG to clear the set value of UP/DOWN.</p> <p>5: Coast to stop. Press QUICK/JOG to coast to stop.</p> <p>6: Shift the given manner of running commands. Press QUICK/JOG to shift the given manner of running commands.</p> <p>7: Quick commission mode(committee according to the non-factory parameter)</p> <p>Note: Press QUICK/JOG to shift between forward rotation and reverse rotation, the inverter does not remember the state after shifting during powering off. The inverter will run in the running direction set according to parameter P00.13 during next powering on.</p>	1	◎
P07.03	<p>Shifting sequence selection of QUICK/JO</p> <p>function selection</p>	<p>When P07.06=6, set the shifting sequence of running command channels.</p> <p>0: Keypad control → terminals control → communication control</p> <p>1: Keypad control ← → terminals control ← → communication control</p>	0	○

Function code	Name	Detailed instruction of parameters	Default value	Modify
	commands	3:Terminals control←→communication control		
P07.04	<p>STOP/RS</p> <p>stop function</p>	<p>STOP/RST is valid for stop function. STOP/RST is valid in any state for the fault reset.</p> <p>0:Only valid for the keypad control</p> <p>1:Both valid for keypad and terminals control</p> <p>2:Both valid for keypad and communication control</p> <p>3:Valid for all control modes</p>	0	<input type="radio"/>
P07.05	Parameter state 1	<p>0x0000~0xFFFF</p> <p>BIT0:running frequency (Hz on)</p> <p>BIT1:set frequency(Hz flickering)</p> <p>BIT2:bus voltage (Hz on)</p> <p>BIT3:output voltage(V on)</p> <p>BIT4:output current(A on)</p> <p>BIT5:running rotation speed (rpm on)</p> <p>BIT6:output power(% on)</p> <p>BIT7:output torque(% on)</p> <p>BIT8:PID reference(% flickering)</p> <p>BIT9:PID feedback value(% on)</p> <p>BIT10:input terminals state</p> <p>BIT11:output terminals state</p> <p>BIT12:torque set value(% on)</p> <p>BIT13:pulse counter value</p> <p>BIT14:length value</p> <p>BIT15:PLC and the current stage in multi-step speed</p>	0x03FF	<input type="radio"/>
P07.06	Parameter state 2	<p>0x0000~0xFFFF</p> <p>BIT0: AI1 (V on)</p> <p>BIT1: AI2 (V on)</p> <p>BIT2: AI3 (V on)</p> <p>BIT3: HDI frequency</p> <p>BIT4: motor overload percentage (% on)</p> <p>BIT5: the inverter overload percentage (% on)</p> <p>BIT6: ramp frequency given value(Hz on)</p>	0x0000	<input type="radio"/>

Function code	Name	Detailed instruction of parameters	Default value	Modify
		BIT7: linear speed BIT8: AC inlet current (A on) BIT9~15:reserved		
P07.07	Parameters for stopping state	0x0000~0xFFFF BIT0:set frequency(Hz on, frequency flickering slowly) BIT1:bus voltage (V on) BIT2:input terminals state BIT3:output terminals state BIT4:PID reference (% flickering) BIT5:PID feedback value(% flickering) BIT6:torque reference(% flickering) BIT7: AI1 (V on) BIT8: AI2 (V on) BIT9: AI3 (V on) BIT10: HDI frequency BIT11:PLC and the current stage in multi-step speed BIT12:pulse counters BIT13:length value BIT14~BIT15:reserved	0x00FF	<input type="radio"/>
P07.08	Frequency coefficient	0.01~10.00 Displayed frequency=running frequency* P07.08	1.00	<input type="radio"/>
P07.09	Rotation speed coefficient	0.1~999.9% Mechanical rotation speed =120*displayed running frequency×P07.09/motor pole pairs	100.0 %	<input type="radio"/>
P07.10	Linear speed coefficient	0.1~999.9% Linear speed= Mechanical rotation speed×P07.10	1.0%	<input type="radio"/>
P07.11	Rectifier bridge module	-20.0~120.0℃		<input checked="" type="radio"/>

Function code	Name	Detailed instruction of parameters	Default value	Modify
	temperature			
P07.12	Converter module temperature	-20.0~120.0℃		●
P07.13	Software version	1.00~655.35		●
P07.14	Local accumulative running time	0~65535h		●
P07.15	High bit of power consumption	Display the power used by the inverter. The power consumption of the inverter =P07.15*1000+P07.16		●
P07.16	Low bit of power consumption	Setting range of P07.15: 0~65535*(\times 1000) Setting range of P07.16: 0.0~999.9°		●
P07.17	Reserved	Reserved		●
P07.18	The rated power of the inverter	0.4~3000.0kW		●
P07.19	The rated voltage of the inverter	50~1200V		●
P07.20	The rated current of the inverter	0.1~6000.0A		●
P07.21	Factory	0x0000~0xFFFF		●

Function code	Name	Detailed instruction of parameters	Default value	Modify
	bar code 1			
P07.22	Factory bar code 2	0x0000~0xFFFF		●
P07.23	Factory bar code 3	0x0000~0xFFFF		●
P07.24	Factory bar code 4	0x0000~0xFFFF		●
P07.25	Factory bar code 5	0x0000~0xFFFF		●
P07.26	Factory bar code 6	0x0000~0xFFFF		●
P07.27	Current fault type	0:No fault 1:IGBT U phase protection(OUT1) 2:IGBT V phase protection(OUT2) 3:IGBT W phase protection(OUT3) 4:OC1 5:OC2 6:OC3 7:OV1 8:OV2 9:OV3 10:UV		●

Function code	Name	Detailed instruction of parameters	Default value	Modify
P07.28	Previous fault type	11:Motor overload(OL1) 12:The inverter overload(OL2) 13:Input side phase loss(SPI) 14:Output side phase loss(SPO) 15:Overheat of the rectifier module(OH1) 16:Overheat fault of the inverter module(OH2) 17:External fault(EF) 18:485 communication fault(CE) 19:Current detection fault(ItE) 20:Motor antotune fault(tE)		●
P07.29	Previous 2 fault type	21:EEPROM operation fault(EEP) 22:PID response offline fault(PIDE)		●
P07.30	Previous 3 fault type	23:Braking unit fault(bCE) 24:Running time arrival(END)		●
P07.31	Previous 4 fault type	25:Electrical overload(OL3) 26:Panel communication fault(PCE)		●
P07.32	Previous 5 fault type	27:Parameter uploading fault (UPE) 28:Parameter downloading fault(DNE) 29:PROFIBUS communication fault(E-DP) 30:Ethernet communication fault(E-NET) 31: CANopen communication fault(E-CAN) 32:Grounding short circuit fault 1(ETH1) 33:Grounding short circuit fault 2(ETH2) 34:Speed deviation fault(dEu) 35:Maladjustment(STu) 36: Undervoltage fault(LL) 37:Encoder offline fault (ENC1O) 38: Encoder reverse fault (ENC1D) 39: Encoder Z pulse offline fault (ENC1Z) 43:Motor overtemperature fault (OT)		●
P07.33	Running frequency		0.00 Hz	●

Function code	Name	Detailed instruction of parameters	Default value	Modify
	at current fault			
P07.34	Ramp reference frequency at current fault		0.00 Hz	
P07.35	Output voltage at the current fault		0V	
P07.36	Output current at current fault		0.0A	
P07.37	Bus voltage at current fault		0.0V	
P07.38	The Max. temperature at current fault		0.0°C	
P07.39	Input terminals state at current fault		0	●
P07.40	Output terminals		0	●

Function code	Name	Detailed instruction of parameters	Default value	Modify
	state at current fault			
P07.41	Running frequency at previous fault		0.00 Hz	●
P07.42	Ramp reference frequency at previous fault		0.00 Hz	●
P07.43	Output voltage at previous fault		0V	●
P07.44	The output current at previous fault		0.0A	●
P07.45	Bus voltage at previous fault		0.0V	●
P07.46	The Max. temperature at previous fault		0.0°C	●
P07.47	Input terminals		0	●

Function code	Name	Detailed instruction of parameters	Default value	Modify
	state at previous fault			
P07.48	Output terminals state at previous fault		0	●
P07.49	Running frequency at previous 2 fault		0.00 Hz	●
P07.50	Output voltage at previous 2 faults		0.00 Hz	●
P07.51	Output current at previous 2 faults		0V	●
P07.52	Output current at previous 2 fault		0.0A	●
P07.53	Bus voltage at previous 2 fault		0.0V	●
P07.54	The Max. temperature at		0.0°C	●

Function code	Name	Detailed instruction of parameters	Default value	Modify
	previous 2 fault			
P07.55	Input terminals state at previous 2 fault		0	●
P07.56	Output terminals state at previous 2 fault		0	●
P08 Group Enhanced function				
P08.00	ACC time 2	See P00.11 and P00.12 for detailed definition. Goodrive35 series define four groups of ACC/DEC time which can be selected by P05 group. The first group of ACC/DEC time is the factory default one. Setting range:0.0~3600.0s	Depend on model	<input type="radio"/>
P08.01	DEC time 2		Depend on model	<input type="radio"/>
P08.02	ACC time 3		Depend on model	<input type="radio"/>
P08.03	DEC time 3		Depend on model	<input type="radio"/>
P08.04	ACC time 4		Depend on model	<input type="radio"/>
P08.05	DEC time		Depend on	<input type="radio"/>

Function code	Name	Detailed instruction of parameters	Default value	Modify
	4		model	
P08.06	Jogging frequency	This parameter is used to define the reference frequency during jogging. Setting range: 0.00Hz ~P00.03 (the Max. frequency)	5.00 Hz	<input type="radio"/>
P08.07	Jogging ACC time	The jogging ACC time means the time needed if the inverter runs from 0Hz to the Max. Frequency.	Depend on model	<input type="radio"/>
P08.08	Jogging DEC time	The jogging DEC time means the time needed if the inverter goes from the Max. frequency (P0.03) to 0Hz. Setting range:0.0~3600.0s	Depend on model	<input type="radio"/>
P08.09	Jumping frequency 1	When the set frequency is in the range of jumping frequency, the inverter will run at the edge of the jumping frequency.	0.00 Hz	<input type="radio"/>
P08.10	Jumping frequency range 1	The inverter can avoid the mechanical resonance point by setting the jumping frequency. The inverter can set three jumping frequency. But this function will be invalid if all jumping points are 0.	0.00 Hz	<input type="radio"/>
P08.11	Jumping frequency 2		0.00 Hz	<input type="radio"/>
P08.12	Jumping frequency range 2		0.00 Hz	<input type="radio"/>
P08.13	Jumping frequency 3		0.00 Hz	<input type="radio"/>
P08.14	Jumping frequency range 3	Setting range: 0.00Hz ~P00.03 (the Max. frequency)	0.00 Hz	<input type="radio"/>
P08.15	Overvoltage stall	Setting range:0.0~1000.0	12.0	<input type="radio"/>

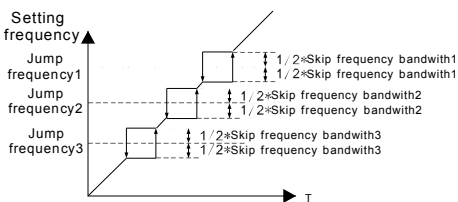

Function code	Name	Detailed instruction of parameters	Default value	Modify
	modulator gain			
P08.16	Speed loop differential time	Setting range:0.00~10.00s	0.00s	<input type="radio"/>
P08.17	Maximum torque of inertia compensation	Setting range:0.0~150.0%	20.0%	<input type="radio"/>
P08.18	Inertia compensation filter times	Setting range:0~10	7	<input type="radio"/>
P08.19	Scale coefficient of high frequency current loop	When P0.00=3, under the value of P08.21, PI is P03.09 and P03.10, but below the value of P08.21, PI is P08.19 and P08.20. Setting range of P08.19:0~20000 Setting range of P08.20:0~20000 Setting range of P08.21:0.0~100.0%	1000	<input type="radio"/>
P08.20	Integral coefficient of high frequency current loop		1000	<input type="radio"/>
P08.21	High-frequency switching		100.0 %	<input type="radio"/>

Function code	Name	Detailed instruction of parameters	Default value	Modify
	point of the current loop			
P08.22	Inertia identification torque	Because of the friction, it is necessary to set identification torque for normal inertia identification. 0.0~100.0% (rated torque of the motor)	10.0%	☉
P08.23	Inertia identification	0: No operation 1: Starting identification: press "RUN" to enter into the program after starting identification until display "-END-"; the identified system inertia is saved in P08.24.	0	☉
P08.24	System inertia	The identified system inertia can be set manually when the system inertia is known. The displayed system inertia may be less than 0.001kgm ² for the motors below 1kW. Setting range: 0.000~30.000 kgm ²	0.000 kgm ²	○
P08.25	Inertia compensation enabled	Identifying the system inertia correctly and enabling the inertia compensation can improve the dynamic response of the system. 0: Enabled 1: Disabled	0	○
P08.26	Stopping protection	Ones: Enabling 0:Disabled 1:Enabled Tens: Voltage selection 0: Internal setting 1:P8.27 setting After the valid undervoltage stopping, the inverter will decelerate to stop according to the time set by P08.05.	0x00	○
P08.27	Stopping voltage	Setting range: 250.0~1000.0V	450.0V	○
P08.28	Fault reset	Fault reset times: set the automatic fault reset times.	0	○

Function code	Name	Detailed instruction of parameters	Default value	Modify
	times	If the reset time exceeds this set value, the inverter will stop to wait maintenance.		
P08.29	Interval time of automatic fault reset	Interval time of automatic fault reset: the interval between the time when the fault occurs and the time when the reset action occurs. Setting range of P08.28:0~10 Setting range of P08.29:0.1~3200.0s	1.0s	○
P08.30	Frequency decreasing ratio of the dropping control	The output frequency of the inverter changes as the load. And it is mainly used to balance the power when several inverters drive one load. Setting range:0.00~50.00Hz	0.00 Hz	○
P08.31	Motor shifting	Goodrive35 supports the shift between two motors. This function is used to select the shifting channel. LED ones: shifting channel 0: terminal shifting; digital terminal is 35 1: MODBUS communication shifting 2: PROFIBUS/CANopen communication shifting	0	◎
P08.32	FDT1 electrical level detection value	When the output frequency exceeds the corresponding frequency of FDT electrical level, the multi-function digital output terminals will output the signal of "frequency level detect FDT" until the output frequency decreases to a value lower than	50.00 Hz	○
P08.33	FDT1 retention detection value	(FDT electrical level—FDT retention detection value) the corresponding frequency, the signal is invalid. Below is the ware form diagram:	5.0%	○
P08.34	FDT2 electrical level detection		50.00 Hz	○

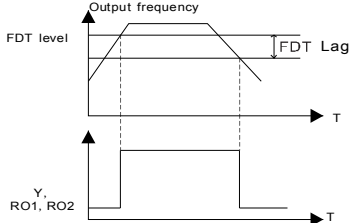
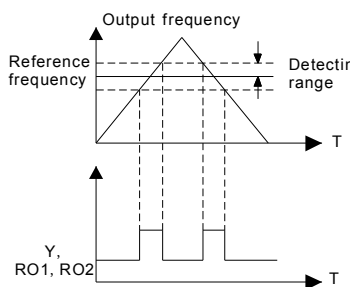
Function code	Name	Detailed instruction of parameters	Default value	Modify
P08.35	value FDT2 retention detection value	 <p>Setting range of P08.32: 0.00Hz~P00.03 (the Max. frequency)</p> <p>Setting range of P08.33: -200.0~100.0% (FDT1 electrical level)</p> <p>Setting range of P08.34: 0.00Hz~P00.03 (the Max. frequency)</p> <p>Setting range of P08.35: -200.0~100.0% (FDT2 electrical level)</p>	5.0%	○
P08.36	Frequency arrival detection value	<p>When the output frequency is among the positive or negative detection range of the set frequency, the multi-function digital output terminal will output the signal of "frequency arrival", see the diagram below for detailed information:</p>  <p>The setting range:0.00Hz~P00.03 (the Max. frequency)</p>	0.00 Hz	○
P08.37	Energy braking	This parameter is used to control the internal braking pipe inside the inverter.	1	○

Function code	Name	Detailed instruction of parameters	Default value	Modify
	enable	0:Disable 1:Enable Note: Only applied to internal braking pipe.		
P08.38	Threshold voltage	After setting the original bus voltage to brake the energy, adjust the voltage appropriately to brake the load. The factory changes with the voltage level. The setting range:200.0~2000.0V	380V voltage: 700.0V 660V voltage: 1120.0V	○
P08.39	Cooling fan running mode	0: Normal mode 1:The fan keeps running after power on	0	○
P08.40	PWM selection	0x000~0x111 LED ones: PWM mode selection 0: PWM mode 1, three-phase modulation and two-modulation 1: PWM mode 2, three-phase modulation LED tens: low-speed carrier frequency limit mode 0: Low frequency and carrier frequency dropping 1: Low frequency and no carrier frequency dropping Hundreds: dead zone compensation 0: Method 1 1: Method 2 The function code is only valid when P0.00=2, and when the carrier frequency is more than 4k, it will drop to 4k automatically.	0x001	◎
P08.41	Over commission selection	0nes: Overcommission selection 0: Invalid 1: Valid Tens: Heavy overcommission factor	0x01	◎

Function code	Name	Detailed instruction of parameters	Default value	Modify
		0~9		
P08.42	Keypad data control	0x000~0x1223 LED ones: frequency enable selection 0: Both \wedge/\vee keys and digital potentiometer adjustments are valid 1: Only \wedge/\vee keys adjustment is valid 2: Only digital potentiometer adjustments is valid 3: Neither \wedge/\vee keys nor digital potentiometer adjustments are valid LED tens: frequency control selection 0: Only valid when P00.06=0 or P00.07=0 1: Valid for all frequency setting manner 2: Invalid for multi-step speed when multi-step speed has the priority LED hundreds: action selection during stopping 0: Setting is valid 1: Valid during running, cleared after stopping 2: Valid during running, cleared after receiving the stop command LED thousands: \wedge/\vee keys and digital potentiometer integral function 0: The integral function is valid 1: The integral function is invalid	0x000 0	○
P08.43	Integral ratio of the keypad potentiometer	0.01~10.00Hz/s	0.10 Hz/s	○
P08.44	UP/DOWN terminals control	0x000~0x221 LED ones: frequency control selection 0:UP/DOWN terminals setting valid	0x000	○

Function code	Name	Detailed instruction of parameters	Default value	Modify
		1:UP/DOWN terminals setting valid LED tens: frequency control selection 0:Only valid when P00.06=0 or P00.07=0 1:All frequency means are valid 2:When the multi-step are priority, it is invalid to the multi-step LED hundreds: action selection when stop 0:Setting valid 1: Valid in the running, clear after stop 2: Valid in the running, clear after receiving the stop commands		
P08.45	UP terminals frequency changing ratio	0.01~50.00Hz/s	0.50 Hz/s	○
P08.46	DOWN terminals frequency changing ratio	0.01~50.00 Hz/s	0.50 Hz/s	○
P08.47	Frequency setting at power loss	0x000~0x111 LED ones: Action selection when power off. 0:Save when power off 1:Clear when power off LED tens: Action selection when MODBUS set frequency off 0:Save when power off 1:Clear when power off LED hundreds:The action selection when other frequency set frequency off 0:Save when power off	0x000	○

Function code	Name	Detailed instruction of parameters	Default value	Modify
		1:Clear when power off		
P08.48	High bit of initial power consumption	This parameter is used to set the original value of the power consumption. The original value of the power consumption	0°	<input type="radio"/>
P08.49	Low bit of initial power consumption	=P08.48*1000+ P08.49 Setting range of P08.48: 0~59999°(k) Setting range of P08.49:0.0~999.9°	0.0°	<input type="radio"/>
P08.50	Magnetic flux braking	This function code is used to enable magnetic flux. 0: Invalid. 100~150: The bigger the coefficient, the stronger the braking is. This inverter is used to increase the magnetic flux to decelerate the motor. The energy generated by the motor during braking can be converted into heat energy by increasing the magnetic flux. The inverter monitors the state of the motor continuously even during the magnetic flux period. So the magnetic flux can be used in the motor stop, as well as to change the rotation speed of the motor. Its other advantages are: Brake immediately after the stop command. It does not need to wait the magnetic flux weaken. Better cooling for motors. The current of the stator other than the rotor increases during magnetic flux braking, while the cooling of the stator is more effective than the rotor.	0	<input type="radio"/>
P08.51	Input power	This function code is used to adjust the displayed current of the AC input side.	0.56	<input type="radio"/>

Function code	Name	Detailed instruction of parameters	Default value	Modify
	factor of the inverter	Setting range:0.00~1.00		
P09 Group PID control				
P09.00	PID reference source	<p>When the frequency command selection (P00.06, P00.07) is 7 or the voltage setting channel selection (P04.27) is 6, the running mode of the inverter is procedure PID controlled.</p> <p>The parameter determines the target given channel during the PID procures.</p> <p>0:Keypad (P09.01) 1: AI1 2: AI2 3: AI3 4: HDI 5:Multi-step speed set 6:MODBUS communication set 7:PROFIBUS/CANopen communication set 8:Ethernet communication set 9:Reserved</p> <p>The setting target of procedure PID is a relative one, 100% of the setting equals to 100% of the response of the controlled system.</p> <p>The system is calculated according to the relative value (0~100.0%).</p> <p>Note: Multi-step speed given, it is realized by setting PA group parameters. PROFIBUS, Ethernet and CANopen communication setting need corresponding extension cards.</p>	0	○
P09.01	Keypad PID preset	<p>When P09.00=0, set the parameter whose basic value is the response value of the system.</p> <p>The setting range:-100.0%~100.0%</p>	0.0%	○

Function code	Name	Detailed instruction of parameters	Default value	Modify
P09.02	PID feedback source	Select the PID channel by the parameter. 0: AI1 1: AI2 2: AI3 3: HDI 4:MODBUS communication feedback 5:PROFIBUS/CANopen communication feedback 6:Ethernet communication feedback 7:Reserved Note: The reference and feedback channel can not coincide, otherwise, PID can not control effectively.	0	<input type="radio"/>
P09.03	PID output feature	0: PID output is positive: when the feedback signal exceeds the PID given value, the output frequency of the inverter will decrease to balance the PID. For example, the strain PID control during wrap-up 1: PID output is negative: When the feedback signal is stronger than the PID given value, the output frequency of the inverter will increase to balance the PID. For example, the strain PID control during wrap down	0	<input type="radio"/>
P09.04	Proportional gain (Kp)	The function is applied to the proportional gain P of PID input. P determines the strength of the whole PID adjuster. The parameter of 100 means that when the offset of PID feedback and given value is 100%, the adjusting range of PID adjuster is the Max. frequency (ignoring integral and differential function). The setting range:0.00~100.00	1.00	<input type="radio"/>
P09.05	Integral time(Ti)	This parameter determines the speed of PID adjuster to carry out integral adjustment on the deviation of PID feedback and reference. When the deviation of PID feedback and reference is	1.00s	<input type="radio"/>

Function code	Name	Detailed instruction of parameters	Default value	Modify
		100%, the integral adjustor works continuously after the time (ignoring the proportional effect and differential effect) to achieve the Max. Frequency (P00.03) or the Max. Voltage (P04.31). Shorter the integral time, stronger is the adjustment Setting range: 0.00~50.00s		
P09.06	Differential time(Td)	This parameter determines the strength of the change ratio when PID adjustor carries out integral adjustment on the deviation of PID feedback and reference. If the PID feedback changes 100% during the time, the adjustment of integral adjustor (ignoring the proportional effect and differential effect) is the Max. Frequency (P00.03) or the Max. Voltage (P04.31). Longer the integral time, stronger is the adjusting. Setting range: 0.00~10.00s	0.00s	<input type="radio"/>
P09.07	Sampling cycle(T)	This parameter means the sampling cycle of the feedback. The adjustor operates each sampling cycle. The longer the sapling cycle is, the slower the response is. Setting range: 0.001~1.000s	0.001s	<input type="radio"/>
P09.08	PID control deviation limit	The output of PID system is the maximum deviation relative to close loop reference. As shown in the diagram below, PID adjustor stops to work during the deviation limit. Set the function properly to adjust the accuracy and stability of the system.	0.0%	<input type="radio"/>

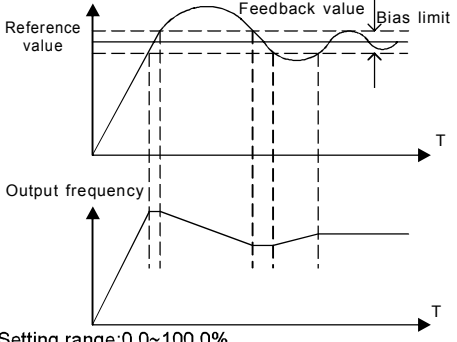
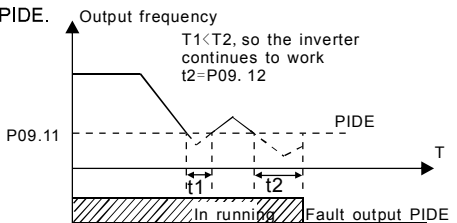
Function code	Name	Detailed instruction of parameters	Default value	Modify
		 <p>Setting range:0.0~100.0%</p>		
P09.09	Output upper limit of PID	This parameter is used to set the upper and lower limit of the PID adjustor output. 100.0 % corresponds to max. frequency or the max. voltage of (P04.31)	100.0 %	<input type="radio"/>
P09.10	Output lower limit of PID	Setting range of P09.09: P09.10~100.0% Setting range of P09.10: -100.0%~P09.09	-50.0 %	<input type="radio"/>
P09.11	Detection value of feedback offline	Set the detection value of feedback offline, when the feedback detection value is smaller than or equals to the detected value, and the lasting time exceeds the set value in P09.12, the inverter will report "PID feedback offline fault" and the keypad will display PIDE.	0.0%	<input type="radio"/>
P09.12	Detection time of feedback offline	 <p>Setting range of P09.11: 0.0~100.0% Setting range of P09.12: 0.0~3600.0s</p>	1.0s	<input type="radio"/>
P09.13	PID adjustment	0x000~0x111 LED ones:	0x001	<input type="radio"/>

Function code	Name	Detailed instruction of parameters	Default value	Modify
		<p>0: Keep on integral adjustment when the frequency achieves the upper and low limit; the integration shows the change between the reference and the feedback unless it reaches the internal integral limit. When the trend between the reference and the feedback changes, it needs more time to offset the impact of continuous working and the integration will change with the trend.</p> <p>1: Stop integral adjustment when the frequency achieves the upper and low limit. If the integration keeps stable, and the trend between the reference and the feedback changes, the integration will change with the trend quickly.</p> <p>LED tens: P00.08 is 0</p> <p>0: The same with the setting direction; if the output of PID adjustment is different from the current running direction, the internal will output 0 forcedly.</p> <p>1: Opposite to the setting direction</p> <p>LED hundreds: P00.08 is 0</p> <p>0: Limit to the maximum frequency</p> <p>1: Limit to frequency A</p>		
P09.14	PID deviation limit	0.0~200.0%	200.0 %	○
P09.15	PID command of ACC/DEC time	0.0~1000.0s	0.0s	○
P09.16	PID output filter time	0.000~10.000s	0.000s	○

Function code	Name	Detailed instruction of parameters	Default value	Modify
P09.17	PID pre-setting	-100.0~100.0%	0.0%	<input type="radio"/>
P09.18	Reserved	0~65536	0	<input type="radio"/>
P09.19	Reserved	0~65536	0	<input type="radio"/>
P09.20	Reserved	0~65536	0	<input type="radio"/>
P10 Group Simple PLC and multi-step speed control				
P10.00	Simple PLC	0: Stop after running once. The inverter has to be commanded again after finishing a cycle. 1: Run at the final value after running once. After finish a signal, the inverter will keep the running frequency and direction of the last run. 2: Cycle running. The inverter will keep on running until receiving a stop command d. And then, the system will stop.	0	<input type="radio"/>
P10.01	Simple PLC memory	0: Power loss without memory 1: Power loss memory;PLC record the running stage and frequency when power loss.	0	<input type="radio"/>
P10.02	Multi-step speed 0	The frequency setting range of stage 0~15: -100.0~100.0%, 100.0% of the frequency setting corresponds to the Max. Frequency P00.03.	0.0%	<input type="radio"/>
P10.03	The running time of step 0	The operation time setting of stage 0~15: the time unit is determined by P10.37. When selecting simple PLC running, set P10.02~P10.33 to define the	0.0s	<input type="radio"/>
P10.04	Multi-step speed 1	running frequency and time of all stages. Note: The symbol of multi-step determines the	0.0%	<input type="radio"/>
P10.05	The running time of step 1	running direction of simple PLC. The negative value means reverse rotation.	0.0s	<input type="radio"/>

Function code	Name	Detailed instruction of parameters	Default value	Modify	
P10.06	Multi-step speed 2	<p>ACC time (2 stages)</p> <p>DEC time (2 stages)</p>	0.0%	<input type="radio"/>	
P10.07	The running time of step 2		0.0s	<input type="radio"/>	
P10.08	Multi-step speed 3		0.0%	<input type="radio"/>	
P10.09	The running time of step 3		0.0s	<input type="radio"/>	
P10.10	Multi-step speed 4		0.0%	<input type="radio"/>	
P10.11	The running time of step 4		0.0s	<input type="radio"/>	
P10.12	Multi-step speed 5		0.0%	<input type="radio"/>	
P10.13	The running time of step 5		If multi-step speed operation is selected, multi-step speeds are in the range of $-f_{max} \sim f_{max}$ and it can be set continuously.	0.0s	<input type="radio"/>
P10.14	Multi-step speed 6		Goodrive35 series inverters can set 16 stages speed, selected by the combination of multi-step terminals 1~4(select the setting by S terminals, the	0.0%	<input type="radio"/>
P10.15	The running time of step 6		corresponding function codes are P05.01~P05.09), corresponding to the speed 1 to speed 15.	0.0s	<input type="radio"/>
P10.16	Multi-step		0.0%	<input type="radio"/>	

Function code	Name	Detailed instruction of parameters	Default value	Modify
	speed 7	<p>When terminal 1, terminal 2, terminal 3, terminal 4=OFF, the frequency input manner is selected via code P00.06 or P00.07. When terminal 1, terminal 2, terminal 3, terminal 4 aren't off, it runs at multi-step which takes precedence of keypad, analog value, high-speed pulse, PLC, communication frequency input.</p> <p>The relationship between terminal 1, terminal 2, terminal 3, terminal 4 and multi-step speed is as following:</p>		
P10.17	The running time of step 7		0.0s	<input type="radio"/>
P10.18	Multi-step speed 8		0.0%	<input type="radio"/>
P10.19	The running time of step 8		0.0s	<input type="radio"/>
P10.20	Multi-step speed 9		0.0%	<input type="radio"/>
P10.21	The running time of step 9		0.0s	<input type="radio"/>
P10.22	Multi-step speed 10		0.0%	<input type="radio"/>
P10.23	The running time of step 10		0.0s	<input type="radio"/>
P10.24	Multi-step speed 11		0.0%	<input type="radio"/>
P10.25	The running time of step 11		0.0s	<input type="radio"/>
P10.26	Multi-step speed 12		0.0%	<input type="radio"/>

Function code	Name	Detailed instruction of parameters	Default value	Modify																																																			
P10.27	The running time of step 12	<table border="1"> <tr><td>Terminal 1</td><td>OFF</td><td>ON</td><td>OFF</td><td>ON</td><td>OFF</td><td>ON</td><td>OFF</td><td>ON</td></tr> <tr><td>Terminal 2</td><td>OFF</td><td>OFF</td><td>ON</td><td>ON</td><td>OFF</td><td>OFF</td><td>ON</td><td>ON</td></tr> <tr><td>Terminal 3</td><td>OFF</td><td>OFF</td><td>OFF</td><td>OFF</td><td>ON</td><td>ON</td><td>ON</td><td>ON</td></tr> </table>	Terminal 1	OFF	ON	OFF	ON	OFF	ON	OFF	ON	Terminal 2	OFF	OFF	ON	ON	OFF	OFF	ON	ON	Terminal 3	OFF	OFF	OFF	OFF	ON	ON	ON	ON	0.0s	<input type="radio"/>																								
Terminal 1	OFF	ON	OFF	ON	OFF	ON	OFF	ON																																															
Terminal 2	OFF	OFF	ON	ON	OFF	OFF	ON	ON																																															
Terminal 3	OFF	OFF	OFF	OFF	ON	ON	ON	ON																																															
P10.28	Multi-step speed 13	<table border="1"> <tr><td>Terminal 4</td><td>OFF</td><td>OFF</td><td>OFF</td><td>OFF</td><td>OFF</td><td>OFF</td><td>OFF</td><td>OFF</td></tr> <tr><td>Step</td><td>0</td><td>1</td><td>2</td><td>3</td><td>4</td><td>5</td><td>6</td><td>7</td></tr> </table>	Terminal 4	OFF	OFF	OFF	OFF	OFF	OFF	OFF	OFF	Step	0	1	2	3	4	5	6	7	0.0%	<input type="radio"/>																																	
Terminal 4	OFF	OFF	OFF	OFF	OFF	OFF	OFF	OFF																																															
Step	0	1	2	3	4	5	6	7																																															
P10.29	The running time of step 13	<table border="1"> <tr><td>Terminal 1</td><td>OFF</td><td>ON</td><td>OFF</td><td>ON</td><td>OFF</td><td>ON</td><td>OFF</td><td>ON</td></tr> <tr><td>Terminal 2</td><td>OFF</td><td>OFF</td><td>ON</td><td>ON</td><td>OFF</td><td>OFF</td><td>ON</td><td>ON</td></tr> <tr><td>Terminal 3</td><td>OFF</td><td>OFF</td><td>OFF</td><td>OFF</td><td>ON</td><td>ON</td><td>ON</td><td>ON</td></tr> <tr><td>Terminal 4</td><td>ON</td><td>ON</td><td>ON</td><td>ON</td><td>ON</td><td>ON</td><td>ON</td><td>ON</td></tr> </table>	Terminal 1	OFF	ON	OFF	ON	OFF	ON	OFF	ON	Terminal 2	OFF	OFF	ON	ON	OFF	OFF	ON	ON	Terminal 3	OFF	OFF	OFF	OFF	ON	ON	ON	ON	Terminal 4	ON	ON	ON	ON	ON	ON	ON	ON	0.0s	<input type="radio"/>															
Terminal 1	OFF	ON	OFF	ON	OFF	ON	OFF	ON																																															
Terminal 2	OFF	OFF	ON	ON	OFF	OFF	ON	ON																																															
Terminal 3	OFF	OFF	OFF	OFF	ON	ON	ON	ON																																															
Terminal 4	ON	ON	ON	ON	ON	ON	ON	ON																																															
P10.30	Multi-step speed 14	<table border="1"> <tr><td>Step</td><td>8</td><td>9</td><td>10</td><td>11</td><td>12</td><td>13</td><td>14</td><td>15</td></tr> </table>	Step	8	9	10	11	12	13	14	15	0.0%	<input type="radio"/>																																										
Step	8	9	10	11	12	13	14	15																																															
P10.31	The running time of step 14		0.0s	<input type="radio"/>																																																			
P10.32	Multi-step speed 15		0.0%	<input type="radio"/>																																																			
P10.33	The running time of step 15		0.0s	<input type="radio"/>																																																			
P10.34	Simple PLC 0~7 step ACC/DEC time	<p>Below is the detailed instruction:</p> <table border="1"> <thead> <tr> <th>Function code</th> <th colspan="2">Binary bit</th> <th>Step</th> <th>ACC/DEC 0</th> <th>ACC/DEC 1</th> <th>ACC/DEC 2</th> <th>ACC/DEC 3</th> </tr> </thead> <tbody> <tr> <td rowspan="6">P10.34</td> <td>BIT1</td> <td>BIT0</td> <td>0</td> <td>00</td> <td>01</td> <td>10</td> <td>11</td> </tr> <tr> <td>BIT3</td> <td>BIT2</td> <td>1</td> <td>00</td> <td>01</td> <td>10</td> <td>11</td> </tr> <tr> <td>BIT6</td> <td>BIT4</td> <td>2</td> <td>00</td> <td>01</td> <td>10</td> <td>11</td> </tr> <tr> <td>BIT7</td> <td>BIT5</td> <td>3</td> <td>00</td> <td>01</td> <td>10</td> <td>11</td> </tr> <tr> <td>BIT9</td> <td>BIT8</td> <td>4</td> <td>00</td> <td>01</td> <td>10</td> <td>11</td> </tr> <tr> <td>BIT11</td> <td>BIT10</td> <td>5</td> <td>00</td> <td>01</td> <td>10</td> <td>11</td> </tr> </tbody> </table>	Function code	Binary bit		Step	ACC/DEC 0	ACC/DEC 1	ACC/DEC 2	ACC/DEC 3	P10.34	BIT1	BIT0	0	00	01	10	11	BIT3	BIT2	1	00	01	10	11	BIT6	BIT4	2	00	01	10	11	BIT7	BIT5	3	00	01	10	11	BIT9	BIT8	4	00	01	10	11	BIT11	BIT10	5	00	01	10	11	0x0000	<input type="radio"/>
Function code	Binary bit		Step	ACC/DEC 0	ACC/DEC 1	ACC/DEC 2	ACC/DEC 3																																																
P10.34	BIT1	BIT0	0	00	01	10	11																																																
	BIT3	BIT2	1	00	01	10	11																																																
	BIT6	BIT4	2	00	01	10	11																																																
	BIT7	BIT5	3	00	01	10	11																																																
	BIT9	BIT8	4	00	01	10	11																																																
	BIT11	BIT10	5	00	01	10	11																																																
P10.35	Simple PLC 8~15 step ACC/DEC time		0x0000	<input type="radio"/>																																																			

Function code	Name	Detailed instruction of parameters	Default value	Modify																																																																							
		<table border="1"> <tr> <td rowspan="10" style="vertical-align: middle;">P10.35</td> <td>BIT13</td> <td>BIT12</td> <td>6</td> <td>00</td> <td>01</td> <td>10</td> <td>11</td> </tr> <tr> <td>BIT15</td> <td>BIT14</td> <td>7</td> <td>00</td> <td>01</td> <td>10</td> <td>11</td> </tr> <tr> <td>BIT1</td> <td>BIT0</td> <td>8</td> <td>00</td> <td>01</td> <td>10</td> <td>11</td> </tr> <tr> <td>BIT3</td> <td>BIT2</td> <td>9</td> <td>00</td> <td>01</td> <td>10</td> <td>11</td> </tr> <tr> <td>BIT5</td> <td>BIT4</td> <td>10</td> <td>00</td> <td>01</td> <td>10</td> <td>11</td> </tr> <tr> <td>BIT7</td> <td>BIT6</td> <td>11</td> <td>00</td> <td>01</td> <td>10</td> <td>11</td> </tr> <tr> <td>BIT9</td> <td>BIT8</td> <td>12</td> <td>00</td> <td>01</td> <td>10</td> <td>11</td> </tr> <tr> <td>BIT11</td> <td>BIT10</td> <td>13</td> <td>00</td> <td>01</td> <td>10</td> <td>11</td> </tr> <tr> <td>BIT13</td> <td>BIT12</td> <td>14</td> <td>00</td> <td>01</td> <td>10</td> <td>11</td> </tr> <tr> <td>BIT15</td> <td>BIT14</td> <td>15</td> <td>00</td> <td>01</td> <td>10</td> <td>11</td> </tr> </table> <p>After users select the corresponding ACC/DEC time, the combining 16 binary bit can be changed into hexadecimal bit, and then set the corresponding function codes. ACC/DEC time 1 is set by P00.11 and P00.12; ACC/DEC time 2 is set by P08.00 and P08.01; ACC/DEC time 3 is set by P08.02 and P08.03; ACC/DEC time 4 is set by P08.04 and P08.05. Setting range: -0x0000~0xFFFF</p>	P10.35	BIT13	BIT12	6	00	01	10	11	BIT15	BIT14	7	00	01	10	11	BIT1	BIT0	8	00	01	10	11	BIT3	BIT2	9	00	01	10	11	BIT5	BIT4	10	00	01	10	11	BIT7	BIT6	11	00	01	10	11	BIT9	BIT8	12	00	01	10	11	BIT11	BIT10	13	00	01	10	11	BIT13	BIT12	14	00	01	10	11	BIT15	BIT14	15	00	01	10	11		
P10.35	BIT13	BIT12		6	00	01	10	11																																																																			
	BIT15	BIT14		7	00	01	10	11																																																																			
	BIT1	BIT0		8	00	01	10	11																																																																			
	BIT3	BIT2		9	00	01	10	11																																																																			
	BIT5	BIT4		10	00	01	10	11																																																																			
	BIT7	BIT6		11	00	01	10	11																																																																			
	BIT9	BIT8		12	00	01	10	11																																																																			
	BIT11	BIT10		13	00	01	10	11																																																																			
	BIT13	BIT12		14	00	01	10	11																																																																			
	BIT15	BIT14	15	00	01	10	11																																																																				
P10.36	PLC restart	0: Restart from the first step; stop during running (cause by the stop command, fault or power loss), run from the first stage after restart. 1: Continue to run from the stop frequency; stop during running(cause by stop command and fault), the inverter will record the running time automatically, enter into the stage after restart and keep the remaining running at the setting frequency.	0	⊙																																																																							
P10.37	Multi-step time unit	0: Seconds;the running time of all steps is counted by second 1: Minutes;the running time of all steps is counted by minute	0	⊙																																																																							
P11 Group Protective parameters																																																																											

Function code	Name	Detailed instruction of parameters	Default value	Modify						
P11.00	Phase loss protection	0x00~0x11 LED ones: 0: Input phase loss protection disable 1: Input phase loss protection enable LED tens: 0: Input phase loss protection disable 1: Input phase loss protection enable	0x11	<input type="radio"/>						
P11.01	Frequency-decreasing at sudden power loss	0: Enable 1: Disable	0	<input type="radio"/>						
P11.02	Frequency decreasing ratio at sudden power loss	Setting range: 0.00Hz/s~P00.03 (the Max. frequency) After the power loss of the grid, the bus voltage drops to the sudden frequency-decreasing point, the inverter begin to decrease the running frequency at P11.02, to make the inverter generate power again. The returning power can maintain the bus voltage to ensure a rated running of the inverter until the recovery of power. <table border="1" data-bbox="359 948 668 1056"> <tr> <td>Voltage degree</td> <td>380V</td> <td>660V</td> </tr> <tr> <td>Frequency-decreasing threshold</td> <td>460V</td> <td>800V</td> </tr> </table> <p>Note: 1. Adjust the parameter properly to avoid the stopping caused by inverter protection during the switching of the grid. 2. Prohibition of input phase protection can enable this function.</p>	Voltage degree	380V	660V	Frequency-decreasing threshold	460V	800V	10.00 Hz/s	<input type="radio"/>
Voltage degree	380V	660V								
Frequency-decreasing threshold	460V	800V								
P11.03	Overvoltage stall protection	0:Disable 1:Enable	0	<input type="radio"/>						

Function code	Name	Detailed instruction of parameters	Default value	Modify
P11.04	Voltage protection of overvoltage stall	120~150%(standard bus voltage)(380V)	136%	○
		120~150%(standard bus voltage)(660V)	120%	
P11.05	Current limit action selection	<p>The actual increasing ratio of motor speed is lower than the ratio of output frequency because of the big load during ACC running. It is necessary to take measures to avoid overcurrent fault and the inverter trips.</p> <p>0nes:current limit setting 0:Invalid 1:Valid</p>	1	⊙
P11.06	Automatic current limit	During the running of the inverter, it will detect the output current and compare it with the limit level defined in P11.06. If it exceeds the level, the inverter will run at stable frequency in ACC running, or the	160.0 %	⊙
P11.07	Frequency decreasing ratio during current limit	inverter will derate to run during the constant running. If it exceeds the level continuously, the output frequency will keep on decreasing to the lower limit. If the output current is detected to be lower than the limit level, the inverter will accelerate to run.	10.00 Hz/s	⊙

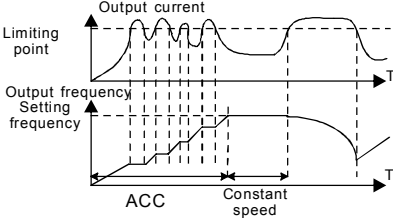
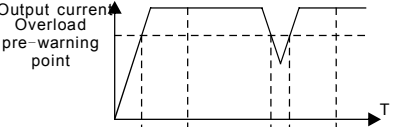
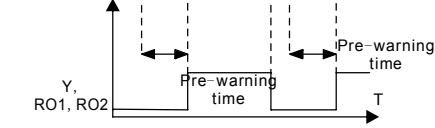
Function code	Name	Detailed instruction of parameters	Default value	Modify
		 <p>Setting range of P11.06:50.0~200.0%</p> <p>Setting range of P11.07:0.00~50.00Hz/s</p>		
P11.08	Overload pre-alarm of motor/inverter	<p>The output current of the inverter or the motor is above P11.09 and the lasting time is beyond P11.10, overload pre-alarm will be output.</p> 	0x000	○
P11.09	Overload pre-alarm detection		150%	○
P11.10	Overload pre-alarm detection time	<p>Setting range of P11.08:</p> <p>Enable and define the overload pre-alarm of the inverter or the motor.</p> <p>Setting range: 0x000~0x131</p> <p>LED ones:</p> <p>0:Overload pre-alarm of the motor, relative to the rated current of the motor</p> <p>1:Overload pre-alarm of the inverter, relative to the rated current of the inverter</p> <p>LED tens:</p> <p>0:The inverter continues to work after underload pre-alarm</p> <p>1:The inverter continues to work after underload</p>	1.0s	○

Function code	Name	Detailed instruction of parameters	Default value	Modify
		pre-alarm and the inverter stops to run after overload fault 2: The inverter continues to work after overload pre-alarm and the inverter stops to run after underload fault LED hundreds : 0:Detection all the time 1:Detection in constant running Setting range of P11.09: P11.11~200% Setting range of P11.10: 0.1~3600.0s		
P11.11	Underload pre-alarm detection	If the inverter current or the output current is lower than P11.11, and its lasting time is beyond P11.12,	50%	<input type="radio"/>
P11.12	Underload pre-alarm detection time	the inverter will output underload pre-alarm. Setting range of P11.11: 0~P11.09 Setting range of P11.12: 0.1~3600.0s	1.0s	<input type="radio"/>
P11.13	Output terminal action during fault	Select the action of fault output terminals on undervoltage and fault reset. 0x00~0x11 LED ones: 0:Action under fault undervoltage 1:No action under fault undervoltage LED tens: 0:Action during the automatic reset 1:No action during the automatic reset	0x00	<input type="radio"/>
P11.14	Speed deviation detection	0.0~50.0% Set the speed deviation detection time	10.0%	<input checked="" type="radio"/>
P11.15	Speed deviation detection time	This parameter is used to see the speed deviation detection time	1.0s	<input type="radio"/>

Function code	Name	Detailed instruction of parameters		Default value	Modify
		<p>Actual detecting value</p> <p>Setting detecting value</p> <p>Speed</p> <p>t_1 t_2</p> <p>In running Fault output DEu</p> <p>$T_1 < t_2$, so the inverter continues to work $t_2 = P11.13$</p> <p>Setting range: 0.0~10.0s</p>			
P11.16	Open loop vector and VF 0Hz output	0:Invalid 1:Valid; ensure rated output torque when voltage drop		0	○
P12 Group Motor 2					
P12.00	Motor type 2	0:Asynchronous motor 1:Synchronous motor Note: switch the current motor by the switching channel of P08.31.		0	◎
P12.01	Rated power of asynchronous motor 2	0.1~3000.0kW	Set the parameter of the controlled asynchronous motor. In order to ensure the controlling	Depend on model	◎
P12.02	Rated frequency of asynchronous motor 2	0.01Hz~P00.03(the Max. frequency)	performance, set the P12.01~P12.05 according to the name plate of the asynchronous motor. Goodrive35 series	50.00 Hz	◎
P12.03	Rated speed of	1~36000rpm	inverters provide the function of parameter	Depend on	◎

Function code	Name	Detailed instruction of parameters		Default value	Modify
	asynchronous motor 2		autotuning. Correct parameter autotuning comes from the	model	
P12.04	Rated voltage of asynchronous motor 2	0~1200V	correct setting of the motor name plate. In order to ensure the controlling performance, please	Depend on model	☉
P12.05	Rated current of asynchronous motor 2	0.8~6000.0A	configure the motor according to the standard principles, if the gap between the motor and the standard one is huge, the features of the inverter will decrease. Note:reset the rated power of the motor (P12.01), initialize the motor parameter of P12.02~P12.05	Depend on model	☉
P12.06	Stator resistor of asynchronous motor 2	0.001~65.535Ω	After finish the motor parameter autotuning, the set value of P12.06~P12.10 will renew automatically.	Depend on model	○
P12.07	Rotor resistor of asynchronous motor 2	0.001~65.535Ω	These parameters are basic parameters controlled by vectors which directly impact the features.	Depend on model	○
P12.08	Leakage	0.1~6553.5mH	Note: Users cannot	Depend	○

Function code	Name	Detailed instruction of parameters		Default value	Modify
	inductance of asynchronous motor 2		modify the parameters freely.	on model	
P12.09	Mutual inductance of asynchronous motor 2	0.1~6553.5mH		Depend on model	○
P12.10	Non-load current of asynchronous motor 2	0.1~6553.5A		Depend on model	○
P12.11	Magnetic saturation coefficient 1 for the iron core of AM2	0.0~100.0%		85.0%	◎
P12.12	Magnetic saturation coefficient 2 for the iron core of AM2	0.0~100.0%		75.0%	◎
P12.13	Magnetic saturation coefficient	0.0~100.0%		68.0%	◎

Function code	Name	Detailed instruction of parameters		Default value	Modify
	3 for the iron core of AM2				
P12.14	Magnetic saturation coefficient 4 for the iron core of AM2	0.0~100.0%		40.0%	⊙
P12.15	Rated power of synchronous motor 2	0.1~3000.0kW	Set the parameter of the controlled asynchronous motor. In order to ensure the controlling performance, set the P12.151~P12.19 according to the name plate of the asynchronous motor. Goodrive35 series inverters provide the function of parameter autotuning. Correct parameter autotuning comes from the correct setting of the motor name plate. In order to ensure the controlling performance, please configure the motor	Depend on model	⊙
P12.16	Rated frequency of synchronous motor 2	0.01Hz~P00.03 (the Max. frequency)		50.00 Hz	⊙
P12.17	Number of poles pairs for synchronous motor 2	1~128		2	⊙
P12.18	Rated voltage of synchronous motor 2	0~1200V		Depend on model	⊙
P12.19	Rated current of synchronous motor 2	0.8~6000.0A		Depend on model	⊙

Function code	Name	Detailed instruction of parameters		Default value	Modify
P12.20	Stator resistor of synchronous motor 2	0.001~65.535Ω	according to the standard principles, if the gap between the motor and the standard one is huge, the features of the inverter will decrease. Note: reset the rated power of the motor(P12.15), initialize the motor parameter of P12.16~ P12.19.	Depend on model	○
P12.21	Direct axis inductance of synchronous motor 2	0.01~655.35mH	After finish the motor parameter autotuning, the set value of P12.20~P12.22 will renew automatically.	Depend on model	○
P12.22	Quadrature axis inductance of synchronous motor 2	0.01~655.35mH	These parameters are basic parameters controlled by vectors which directly impact the features. When P00.15=1, the set value of P12.23 can be updated through autotuning automatically, and there is no need to change the value of P12.23; when P00.15=2, the set value of P12.23 can not be updated	Depend on model	○
P12.23	Back EMF constant of synchronous motor 2	When P00.15=2, the set value of P12.23 cannot be updated by autotuning, please count according to the following method. The counter-electromotive force constant can be counted according to the parameters on the name plate of the motor. There	When P00.15=2, the set value of P12.23 can be updated through autotuning automatically, and there is no need to change the value of P12.23; when P00.15=2, the set value of P12.23 can not be updated	320	○

Function code	Name	Detailed instruction of parameters		Default value	Modify
		<p>are three ways to count:</p> <p>1. If the name plate designate the counter-electromotive force constant K_e, then: $E=(K_e \cdot n_N \cdot 2 \pi) / 60$</p> <p>2. If the name plate designate the counter-electromotive force constant $E'(V/1000r/min)$, then: $E=E' \cdot n_N / 1000$</p> <p>3. If the name plate does not designate the above parameters, then: $E=P/\sqrt{3} \cdot I$</p> <p>In the above formulas: n_N is the rated rotation speed, P is the rated power and I is the rated current. Setting range: 0~10000</p>	<p>through autotuning, please account and update the value of P12.23.</p> <p>Note: Users cannot modify the parameters freely.</p>		
P12.24	Initial pole position of synchronous motor 2 (reserved)	0~FFFFH (reserved)		0x0000	●
P12.25	Identification current of synchronous motor 2 (reserved)	0%~50%(the rated current of the motor)(reserved)		10%	●
P12.26	Motor 2 overload	0:No protection 1:Common motor(with low speed compensation)		2	⊙

Function code	Name	Detailed instruction of parameters	Default value	Modify
	protection	2:Variable frequency motor(without low speed compensation)		
P12.27	Motor 2 overload protection coefficient	<p>Times of motor overload $M = I_{out}/(I_n * K)$</p> <p>I_n is the rated current of the motor, I_{out} is the output current of the inverter and K is the motor protection coefficient.</p> <p>So, the bigger the value of K is, the smaller the value of M is. When $M = 116\%$, the fault will be reported after 1 hour, when $M = 200\%$, the fault will be reported after 1 minute, when $M > 400\%$, the fault will be reported instantly.</p> <p>Setting range: 20.0%~120.0%</p>	100.0 %	<input type="radio"/>
P12.28	Correction coefficient of motor 2 power	<p>Correct the power displaying of motor 2.</p> <p>Only impact the displaying value other than the control performance of the inverter.</p> <p>Setting range: 0.00~3.00</p>		<input checked="" type="radio"/>
P12.29	Parameter display of motor 2	<p>0: Display according to the motor type: only the parameters relative to the current motor type are displayed for the convenient for the customers in this mode.</p> <p>1: All parameters are displayed: all parameters are displayed in this mode.</p>	0	<input checked="" type="radio"/>
P13 Group Synchronous motor control				
P13.00	Reduction	0.0~100.0%	80.0%	<input checked="" type="radio"/>

Function code	Name	Detailed instruction of parameters	Default value	Modify
	coefficient of source current			
P13.01	Original pole test mode	0: No test 1: High-frequency superposition (reserved) 2: Pulse superposition	0	☉
P13.02	Source current 1	Source current is the positioning current of the magnetic pole position. Source current 1 is valid under the frequency point of current shifting. Increasing the value can raise the starting torque. Setting range: 0.0%~100.0% (rated current of the motor)	20.0%	○
P13.03	Source current 2	Source current is directional current of the magnetic pole position. Source current 2 is valid under the frequency point of current shifting. There is no need to modify the value generally. Setting range: 0.0%~100.0%(rated current of the motor)	10.0%	○
P13.04	Shift frequency of source current	0.0%~80.0% (the Max. frequency)	20.0%	○
P13.05	Superposing frequency (reserved)	200~1000Hz	500Hz	☉
P13.06	Pulse superposing voltage	0.0~300.0%(rated voltage of the motor)	50.0%	☉
P13.07	Reserved	0~65535	0	○
P13.08	Control parameter 1	0x0000~0xFFFF	0x0000	○

Function code	Name	Detailed instruction of parameters	Default value	Modify
P13.09	Control parameter 2	0.00~655.35	2.00	<input type="radio"/>
P13.10	Reserved	0~65535	0	<input type="radio"/>
P13.11	Maladjustment detection time	Adjust the response of anti-maladjustment. Bigger load inertia may increase the value, but the response will be slower. Setting range: 0.0~10.0s	0.5s	<input type="radio"/>
P13.12	High frequency compensation coefficient	When the motor speed is faster than the rated speed, the parameter is valid, if vibration occurs to the motor, please adjust the parameter. Setting range: 0.0~100.0%	0.0%	<input type="radio"/>
P13.13	Braking current of short-circuit	When P01.00=0 during the starting of the inverter, set P13.14 to a non-zero value to enter the short circuit braking.	0.0%	<input type="radio"/>
P13.14	Braking retention time before starting	When the running frequency is lower than P01.09 during the stopping of the inverter, set 13.15 to a non-zero value to enter into stopping short circuited braking and then carry out the DC braking at the time set by P01.12 (refer to the instruction of P01.09~P01.12) .	0.0s	<input type="radio"/>
P13.15	The braking retention time when stopping	Setting range of P13.13: 0.0~150.0%(the inverter) Setting range of P13.14: 0.0~50.0s Setting range of P13.15: 0.0~50.0s	0.0s	<input type="radio"/>
P14 Group Serial communication				
P14.00	Local communication address	The setting range:1~247 When the master is writing the frame, the communication address of the slave is set to 0; the address is the communication address. All slaves on the MODBUS fieldbus can receive the frame, but the slave doesn't answer. The communication of the drive is unique in the	1	<input type="radio"/>

Function code	Name	Detailed instruction of parameters	Default value	Modify
		communication net. This is the fundamental for the point to point communication between the upper monitor and the drive. Note: The address of the slave cannot set to 0.		
P14.01	Communication baud ratio	Set the digital transmission speed between the upper monitor and the inverter. 0:1200BPS 1:2400BPS 2:4800BPS 3:9600BPS 4:19200BPS 5:38400BPS 6:57600BPS 7:115200BPS Note: The baud rate between the upper PC and the inverter must be the same. Otherwise, the communication is not applied. The bigger the baud rate, the quicker the communication speed.	4	○
P14.02	Digital bit checkout	The data format between the upper monitor and the inverter must be the same. Otherwise, the communication is not applied. 0: No check (N,8,1) for RTU 1:Odd check (E,8,1) for RTU 2:Even check (O,8,1) for RTU 3:No check (N,8,2) for RTU 4: Odd check (E,8,2) for RTU 5:Even check(O,8,2) for RTU	1	○
P14.03	Answer delay	0~200ms The interval time when the drive receives the data and sent it to the upper monitor. If the answer delay is shorter than the system processing time, then the answer delay time is the system processing time, if the answer delay is longer than the system processing time, then after the system deal with the	5 ms	○

Function code	Name	Detailed instruction of parameters	Default value	Modify
		data, waits until achieving the answer delay time to send the data to the upper monitor		
P14.04	Fault time of communication overtime	0.0(invalid), 0.1~60.0s When the function code is set as 0.0, the communication overtime parameter is invalid When the function code is set as non-zero, if the interval time between two communications exceeds the communication overtime, the system will report "485 communication faults" (CE). Generally, set it as invalid; set the parameter in the continuous communication to monitor the communication state.	0.0s	○
P14.05	Transmission on fault processing	0:Alarm and stop freely 1:No alarm and continue to run 2:No alarm and stop according to the stop mode (only under the communication control) 3:No alarm and stop according to the stop mode (under all control modes)	0	○
P14.06	Communication processing	0x00~0x11 LED ones: 0: Write with response: the inverter will respond to all reading and writing commands of the upper monitor. 1: Write without response: the inverter only responds to the reading command other than the writing command of the drive. The communication efficiency can be increased by this method. LED tens: 0: Communication encrypting valid 1: Communication encrypting invalid	0x00	○
P15 Group PROFIBUS/CANopen function				
P15.00	Module type	0: PROFIBUS; 1: CANopen Select communication protocol	0	◎

Function code	Name	Detailed instruction of parameters	Default value	Modify
P15.01	Module address	0~127 This function code is used to designate the address of the inverter. Note: 0 is the broadcast address, when set it as broadcast address, only receive the radio command of the upper monitor other than answering the upper monitor.	2	⊙
P15.02	PZD2 receiving	0:Invalid 1:Setting frequency (0~Fmax(unit:0.01Hz))	0	○
P15.03	PZD3 receiving	2: PID reference, range (0~1000,1000 corresponds to 100.0%)	0	○
P15.04	PZD4 receiving	3: PID feedback, range (0~1000,1000 corresponds to 100.0%)	0	○
P15.05	PZD5 receiving	4:Torque setting (-3000~3000,1000 corresponds to 100.0% the rated current of the motor)	0	○
P15.06	PZD6 receiving	5:Upper frequency of forward rotation (0~Fmax unit:0.01Hz)	0	○
P15.07	PZD7 receiving	6: Upper frequency of reverse rotation (0~Fmax(unit:0.01Hz))	0	○
P15.08	PZD8 receiving	7:Electromotion torque upper limit (0~3000,1000 corresponds to 100.0%of the rated current of the motor)	0	○
P15.09	PZD9 receiving	8:Braking torque upper limit (0~2000,1000 corresponds to 100.0% of the rated current of the motor)	0	○
P15.10	PZD10 receiving	9:Virtual input terminals command Range:0x000~0x1FF	0	○
P15.11	PZD11 receiving	10:Virtual output terminals command Range:0x00~0x0F	0	○
P15.12	PZD12 receiving	11:Voltage setting value(special for V/F separation)(0~1000,1000 corresponds to 100.0% the rated voltage of the motor) 12: AO output set value 1(-1000~1000, 1000 corresponds to 100.0%)	0	○

Function code	Name	Detailed instruction of parameters	Default value	Modify
		13: AO output set value 2(-1000~1000, 1000 corresponds to 100.0%) 14:High bit of position reference(with sign) 15: Low bit of position reference(without sign) 16: High bit of position feedback(with sign) 17: Low bit of position feedback (without sign) 18: Position feedback setting 19~20: Reserved		
P15.13	PZD2 sending	0: Invalid 1: Running frequency(*100,Hz)	0	○
P15.14	PZD3 sending	2: Setting frequency(*100,Hz) 3: Bus voltage(*10,V)	0	○
P15.15	PZD4 sending	4: Output voltage(*1,V) 5: Output current (*10,A)	0	○
P15.16	PZD5 sending	6: Output torque actual value(*10,%) 7: Output power actual value(*10,%)	0	○
P15.17	PZD6 sending	8:Running rotating speed(*1,RPM) 9:Running linear speed (*1,m/s)	0	○
P15.18	PZD7 sending	10:Ramp given frequency 11:Fault code	0	○
P15.19	PZD8 sending	12:AI1 value (*100,V) 13:AI2 value (*100,V)	0	○
P15.20	PZD9 sending	14:AI3 value (*100,V) 15:PULSE frequency value (*100,kHz)	0	○
P15.21	PZD10 sending	16:Terminals input state 17:Terminals output state	0	○
P15.22	PZD11 sending	18:PID given(*100,%) 19:PID feedback(*100,%)	0	○
P15.23	PZD12 sending	20:Motor rated torque 21: High bit of position reference(with sign) 22: Low bit of position reference(without sign) 23: High bit of position feedback(with sign) 24: Low bit of position feedback (without sign) 25: State words	0	○

Function code	Name	Detailed instruction of parameters	Default value	Modify
P15.24	Temporarily variable 1 for PZD sending	0~65535	0	○
P15.25	Fault time of DP communication overtime	0.0(invalid),0.1~60.0s When this function code is set as 0.0, this function is invalid. When the function code is set as nonzero value, if the internal time between two communication exceeds the communication overtime, the system will report "PROFIBUS communication fault"(E-DP).	0.0s	○
P15.26	Fault time of CANopen communication overtime	0.0(invalid),0.1~60.0s When this function code is set as 0.0, this function is invalid When the function code is set as nonzero value, if the internal time between two communication exceeds the communication overtime, the system will report "CANopen communication fault"(E-CAN)	0.0s	
P15.27	CANopen baudrate	0: 1000k 1: 800k 2: 500k 3: 250k 4: 125k 5: 100k 6: 50k 7: 20k	0	●
P16 Group Ethernet function				
P16.00	Speed setting of the Ethernet communication	0:Self-adapting 1:100M full duplex 2:100M semiduplex 3:10M full duplex 4:10M semiduplex The function code is used to set the Ethernet	0	◎

Function code	Name	Detailed instruction of parameters	Default value	Modify
		communication speed.		
P16.01	IP address 1	0~255 Set the IP address of Ethernet communication The format of IP address: P16.09.P16.10.P16.11.P16.12 For example: IP address is 192.168.0.1.	192	☉
P16.02	IP address 2		168	☉
P16.03	IP address 3		0	☉
P16.04	IP address 4		1	☉
P16.05	Subnet mask 1	0~255 Set the subnet mask of Ethernet communication. The format of IP subnet mask: P16.13.P16.14.P16.15.P16.16. For example:The mask is 255.255.255.0.	255	☉
P16.06	Subnet mask 2		255	☉
P16.07	Subnet mask 3		255	☉
P16.08	Subnet mask 4		0	☉
P16.09	Gateway 1	0~255 Set the gateway of Ethernet communication	192	☉
P16.10	Gateway 2		168	☉
P16.11	Gateway 3		1	☉
P16.12	Gateway 4		1	☉
P17 Group Monitoring function				
P17.00	Setting frequency	Display current set frequency of the inverter Range: 0.00Hz~P00.03	0.00 Hz	●
P17.01	Output frequency	Display current output frequency of the inverter Range: 0.00Hz~P00.03	0.00 Hz	●
P17.02	Ramp reference frequency	Display current ramp given frequency of the inverter Range: 0.00Hz~P00.03	0.00 Hz	●
P17.03	Output voltage	Display current output voltage of the inverter Range: 0~1200V	0V	●

Function code	Name	Detailed instruction of parameters	Default value	Modify																				
P17.04	Output current	Display current output current of the inverter Range: 0.0~5000.0A	0.0A	●																				
P17.05	Motor speed	Display the rotation speed of the motor. Range: 0~65535RPM	0 RPM	●																				
P17.06	Torque current	Display current torque current of the inverter Range: -3000.0~3000.0A	0.0A	●																				
P17.07	Exciting current	Display current exciting current of the inverter Range: -3000.0~3000.0A	0.0A	●																				
P17.08	Motor power	Display current power of the motor. Setting range: -300.0%~300.0% (the rated current of the motor)	0.0%	●																				
P17.09	Output torque	Display the current output torque of the inverter. Range: -250.0~250.0%	0.0%	●																				
P17.10	Evaluated motor frequency	Evaluate the motor rotor frequency on close loop vector Range: 0.00~ P00.03	0.00 Hz	●																				
P17.11	DC bus voltage	Display current DC bus voltage of the inverter Range: 0.0~2000.0V	0.0V	●																				
P17.12	Digital input terminals state	Display current Switch input terminals state of the inverter <table border="1" style="margin-left: auto; margin-right: auto;"> <tr> <td></td> <td>BIT8</td> <td>BIT7</td> <td>BIT6</td> <td>BIT5</td> </tr> <tr> <td></td> <td>HDI</td> <td>S8</td> <td>S7</td> <td>S6</td> </tr> <tr> <td>BIT4</td> <td>BIT3</td> <td>BIT2</td> <td>BIT1</td> <td>BIT0</td> </tr> <tr> <td>S5</td> <td>S4</td> <td>S3</td> <td>S2</td> <td>S1</td> </tr> </table> Range: 0000~01FF		BIT8	BIT7	BIT6	BIT5		HDI	S8	S7	S6	BIT4	BIT3	BIT2	BIT1	BIT0	S5	S4	S3	S2	S1	0	●
	BIT8	BIT7	BIT6	BIT5																				
	HDI	S8	S7	S6																				
BIT4	BIT3	BIT2	BIT1	BIT0																				
S5	S4	S3	S2	S1																				
P17.13	Digital output terminals state	Display current Switch output terminals state of the inverter <table border="1" style="margin-left: auto; margin-right: auto;"> <tr> <td>BIT3</td> <td>BIT2</td> <td>BIT1</td> <td>BIT0</td> </tr> <tr> <td>RO2</td> <td>RO1</td> <td>HDO</td> <td>Y</td> </tr> </table> Range: 0000~000F	BIT3	BIT2	BIT1	BIT0	RO2	RO1	HDO	Y	0	●												
BIT3	BIT2	BIT1	BIT0																					
RO2	RO1	HDO	Y																					
P17.14	Digital	Display the adjustment through the keypad of the	0.00Hz	●																				

Function code	Name	Detailed instruction of parameters	Default value	Modify
	adjustment	inverter. Range : 0.00Hz~P00.03		
P17.15	Torque reference	Display the torque given, the percentage to the current rated torque of the motor. Setting range: -300.0%~300.0%(the rated current of the motor)	0.0%	●
P17.16	AI1 adjustment voltage	0.00~10.00V	0.00V	●
P17.17	AI2 adjustment voltage	0.00~10.00V	0.00V	●
P17.18	AI3 adjustment voltage	0.00~10.00V	0.00V	●
P17.19	AI1 input voltage	Display analog AI1 input signal Range: 0.00~10.00V	0.00V	●
P17.20	AI2 input voltage	Display analog AI2 input signal Range: 0.00~10.00V	0.00V	●
P17.21	AI3 input voltage	Display analog AI2 input signal Range: -10.00~10.00V	0.00V	●
P17.22	HDI input frequency	Display HDI input frequency Range: 0.00~50.00kHz	0.00 kHz	●
P17.23	PID reference	Display PID given value Range: -100.0~100.0%	0.0%	●
P17.24	PID feedback	Display PID response value Range: -100.0~100.0%	0.0%	●
P17.25	Power factor of the motor	Display the current power factor of the motor. Range: -1.00~1.00	0.00	●

Function code	Name	Detailed instruction of parameters	Default value	Modify
P17.26	Current running time	Display the current running time of the inverter. Range:0~65535min	0min	●
P17.27	Simple PLC and the current step of the multi-step speed	Display simple PLC and the current stage of the multi-step speed Range: 0~15	0	●
P17.28	ASR controller output	The percentage of the rated torque of the relative motor, display ASR controller output Range: -300.0%~300.0% (the rated current of the motor)	0.0%	●
P17.29	Magnetic pole angle of SM	Display synchronous motor Magnetic pole angle Range: 0.0~360.0	0.0	●
P17.30	Phase compensation of SM	Display synchronous motor phase compensation Range: -180.0~180.0	0.0	●
P17.31	High-frequency superimposed current of SM	Display synchronous motor high-frequency Superimposed current Range: 0.0%~200.0%(the rated current of the motor)	0.0	●
P17.32	Magnetic flux linkage	Display the magnetic flux linkage of the motor Range: 0.0%~200.0%	0.0%	●
P17.33	Exciting current reference	Display the exciting current reference in the vector control mode Range: -3000.0~3000.0A	0.0A	●
P17.34	Torque current	Display the torque current reference in the vector control mode	0.0A	●

Function code	Name	Detailed instruction of parameters	Default value	Modify
	reference	Range: -3000.0~3000.0A		
P17.35	AC current	Display the value of inlet current in AC side Range: 0.0~5000.0A	0.0A	●
P17.36	Output torque	Display the output torque. Positive value is in the electromotion state, and negative is in the power generating state Range : -3000.0Nm~3000.0Nm	0.0Nm	●
P17.37	PID deviation	-100.0%~100.0%	0.0%	●
P17.38	PID output	~200.00%~200.00%	0.00%	●
P17.39	Wrong download of parameters	0.00~29.00	0.00	●

Function code	Name	Detailed instruction of parameters	Default value	Modify
P18 States viewing 2				
P18.00	Actual frequency detected by the encoder	P18.00 is the actual frequency of the encoder. If the motor rotates forward, the value is positive; if the motor rotates reverse, the value is negative.-3276.8~3276.7Hz	0.0Hz	●
P18.01	Position counting of the encoder	Position counting of the encoder, 4 times of the frequency 0~65535	0	●
P18.02	Z pulse counting of the encoder	Z pulse counting of the encoder 0~65535	0	●

P18.03	High bit of the position reference	The value will be cleared if stopping. 0~30000	0	●
P18.04	Low bit of the position reference	The value will be cleared if stopping. 0~65535	0	●
P18.05	High bit of the position feedback	The value will be cleared if stopping. 0~30000	0	●
P18.06	Low bit of the position feedback	The value will be cleared if stopping. 0~65535	0	●
P18.07	Position deviation	The deviation between reference position and actual operation position. -32768~32767	0	●
P18.08	Position reference	The reference position of Z pulse when spindle stops. 0~65535	0	●
P18.09	Current position of the spindle	Current position setting when spindle stops. 0~359.99	0.00	●
P18.10	Zero position of the spindle	Current zero position of the spindle when spindle stops. 0~65535	0	●

P18.11	Reverse of Z pulse	Display of Z pulse direction. When the spindle stops, the stopping position of forward and reverse rotation may have a deviation of a few pulses. After adjusting the direction of Z pulse or the AB phase of encoder, the stopping position will be same. 0: Forward 1: Reverse	0	●
P18.12	Z pulse angle	Reserved 0~359.99	0.00	●
P18.13	Fault times of Z pulse	Reserved 0~65535	0	●
P18.14	High bit of Pg1 counting	After power on, the value will be counted continuously. 0~65535	0	●
P18.15	Low bit of Pg1 counting	After power on, the value will be counted continuously. 0~65535	0	●
P18.16	Spare variable	Pulse frequency is converted into setting frequency and keeps valid in pulse position mode and pulse speed mode 0~65535	0	●
P18.17	Pulse command frequency	Forward feedback frequency converted from the pulse command forward feedback in pulse and position mode 0.0~400.0Hz	0.0Hz	●
P18.18	Pulse command forward feedback	The position regulator output frequency in position control. 0.0~400.0Hz	0.0Hz	●
P18.19	Position regulator output	Rotary transformer counting, 0~1024 0.00~400.00Hz	0.00Hz	●

P18.20	Rotary transformer counting	The magnetic position angle from the rotary transformer 0~65535	0	●
P18.21	Rotary transformer angle	Current magnetic position 0.00~359.99	0.00	●
P18.22	Pole angle	0.00~359.99	0.00	●
P18.23	State control word 3	0~65535	0	●
P18.24	High bit of pulse counting Pg2	After power on, the value will be counted continuously. 0~65535	0	●
P18.25	Low bit of pulse counting Pg2	After power on, the value will be counted continuously. 0~65535	0	●
P18.26	Inertia compensation torque	Inertia compensation torque -100.0%~100.0%	0.0%	●
P18.27	Friction compensation torque	The torque value of friction compensation. -100.0%~100.0%	0.0%	●
P18.28	Spindle drive ratio	The drive ratio of encoder installation shaft to spindle when the spindle stops. 0.000~65.535	0.000	●
P18.30	Pole pairs	0~65535	0	●
P20 Encoder				
P20.00	Encoder type	0: Incremental encoder 1: Reserved 2: Rotary transformer encoder 3: Reserved	0	◎

P20.01	Pulse number	Pulse number when the encoder rotates a circle. 0~60000	1024	⊙
P20.02	Encoder direction	0x00~0x11 Ones: AB direction, AB direction, when the encoder reports ENC1O or ENC1D, adjusting the value may change the direction and there is no need to adjust the wiring. 0: Forward 1: Reverse Tens:Z pulse direction, Z pulse direction, it is necessary to adjust the value if the forward and reverse stopping position need to be same when spindle stopping is used. There is no need to modify the parameters in other modes. 0: Forward 1: Reverse	0x00	⊙
P20.03	Offline detection time	Detection time of encoder offline fault. 0.0~100.0s	1.0s	○
P20.04	Encoder reverse fault detection time	Detection time of encoder reverse fault. 0.0~100.0s	0.8s	○
P20.05	Filter times	0x00~0x99 Ones: filter times at low speed, corresponds to $2^{(0\sim9)} * 125\mu s$ Tens: filter times at high speed, corresponds to $2^{(0\sim9)} * 125\mu s$	0x33	○
P20.06	Speed ratio of motor and encoder	It is necessary to set the parameter when the encoder does not install on the motor shaft and the drive ratio is not 1. 0.001~65.535	1.000	○

P20.07	Control parameters of the SM	0x0000~0xFFFF Bit0: Z pulse correction enabling Bit1: Encoder angle correction enabling Bit2: SVC speed detection enable Bit3: Speed detection mode of rotary transformer Bit4: Z pulse capture modes Bit12: Z pulse arrival signal clearance after stop	0x0003	○
P20.08	Offline detection enabling of Z pulse	Z pulse offline fault is ENC1Z. Z pulse detection can be enabled to avoid wrong stopping or control loss which is caused by Z pulse loss when spindle stopping or incremental encoder is used in SM control. 0: Invalid 1: Enabling detection	0	○
P20.09	Initial angle of Z pulse	The relative angle of encoder Z pulse to motor magnetic position. 0.00~359.99	0.00	○
P20.10	Pole initial angle	The relative angle of encoder position to motor magnetic position. 0.00~359.99	0.00	○
P20.11	Autotuning of pole initial angle	After setting the value to 1 or 2, the keypad will display “-RUN-”. And then press “RUN” to begin the autotuning until the keypad display “-END-”. The identified initial angle is saved in P20.09 and P20.10. The pole initial angle after autotuning is more accurate. Generally it is necessary to de-couple the motor for rotation autotuning. 0: No operation 1:Rotating autotuning 2:Autotuning with load (may rotate)	0	◎
P21 Position control				

<p>P21.00</p>	<p>Positioning mode</p>	<p>0x00~0x21</p> <p>Ones: Position control mode when setting close loop vector control. The speed and position mode can be switched through terminals.</p> <p>0: Speed control 1: Position control</p> <p>Tens: position command source</p> <p>0: Pulse string. Positioning through A2 and B2 pulse signal 1: Digital position. Positioning through P21.17 and the positioning modes can be set through P21.16 2: Photoelectric switch positioning. After the terminal receives the signal (set S8 to 43), the stopping positioning begins and the stopping distance is set through P21.17.</p> <p>Hundreds: Position feedback source (reserved)</p> <p>1: PG1 2: PG2</p>	<p>0x00</p>	<p>©</p>
---------------	-------------------------	---	-------------	----------

<p>P21.01</p>	<p>Pulse command</p>	<p>0x0000~0x3113 Ones: pulse mode 0:A/Bquadrature pulse A is forward to B 1:A:PULSE B:SIGN 2:A:Positive PULSE 3:A:Negative PULSE Tens:Pulse direction Bit0:Direction setting 0:Forward 1:Reverse Bit1:Determined by the operation direction 0:Disabled 1:Enabled Hundreds:Pulse and direction selection 0:No frequency multiplication 1: Frequency multiplication Thousands:Pulse control Bit0:Pulse filtering selection 0: Inertial filter 1: Moving average filtering Bit1:Overspeed suppression 0:No suppression 1: Suppression</p>	<p>0x0000</p>	<p>⊙</p>
<p>P21.02</p>	<p>Position loop gain 1</p>	<p>Two position loop gains can be switched through P21.04; in spindle stopping mode, gains can be switched automatically. In dynamic mode, it applied</p>	<p>20.0</p>	<p>○</p>
<p>P21.03</p>	<p>Position loop gain 2</p>	<p>P21.03, but in the locking mode, it applies P21.02. 0.0~400.0</p>	<p>30.0</p>	<p>○</p>

P21.04	Shifting mode of position loop gain	Select the shifting mode of position gain. It is necessary to set P21.05 in torque command shifting, set P21.06 in speed command shifting. 0: No shifting 1: Torque command 2: Speed command 3~5: Reserved	0	<input type="radio"/>
P21.05	Position gain torque shifting	0.0~100.0% (rated torque of the motor)	10.0%	<input type="radio"/>
P21.06	Position gain speed shifting	0.0~100.0% (rated torque of the motor)	10.0%	<input type="radio"/>
P21.07	Smooth filter coefficient of gain shifting	Smooth filter coefficient of position gain shifting. 0~15	5	<input type="radio"/>
P21.08	Output of the position controller	Output limit of the position controller. If the limit value is 0, the controller is invalid for position control, but valid for speed control. 0.0~100.0%(P00.03)	20.0%	<input type="radio"/>
P21.09	Positioning finished range	The positioning finished signal of output position when the position deviation is below P21.09 and the lasting time is above P21.10. 0~1000	10	<input type="radio"/>
P21.10	Detection time of the positioning	0.0~1000.0ms	10.0ms	<input type="radio"/>

P21.11	Numerator of the position command ratio	Used to change the corresponding relationship of adjusting position commands and actual operation displacement. 1~65535	1000	○
P21.12	Denominator of the position command ratio	1~65535	1000	○
P21.13	Position forward feedback gain	Generally no need to modify. 0.00~120.00%	100.00%	○
P21.14	Position forward feedback filter time coefficient	Position forward feedback filter time coefficient when the position of pulse string is given. 0.0~3200.0ms	3.0ms	○
P21.15	Position command filter time coefficient	Filter time coefficient of position reference for pulse string. 0.0~3200.0ms	0.0ms	◎

<p>P21.16</p>	<p>Digital positioning mode</p>	<p>0x0000~0xFFFF Bit0: positioning mode 0: Relative position 1: Absolute position (Origin point) Bit1: Positioning loop selection 0: Terminal loop positioning 1: Automatic loop positioning Bit2: Circulation mode 0: Continuous 1: Repeated Bit3: P21.17 Digital setting 0: Incremental mode 1: Position mode Bit4: Origin search 0: Search once 1: Search in every running Bit5: Origin correction mode 0: Real-time correction 1: Single correction Bit6: Positioning complete signal selection 0: Valid in the hole time 1: Always valid Bit7: First positioning selection 0: Invalid 1: Valid Bit8: Positioning signal enabling selection 0: Pulse signal 1: Electric level signal Bit9: Position source 0: P21.17 setting 1: PROFIBUS/CANopen setting</p>	<p>0x0000</p>	<p>○</p>
<p>P21.17</p>	<p>Location figures reference</p>	<p>Set the position place of digital setting Actual position = P21.17 * P21.11 / P21.12 0~65535</p>	<p>0</p>	<p>○</p>

P21.18	Positioning speed setting	Positioning speed setting 0:P21.19 digital setting 1: A11 setting 2: A12 setting 3: A13 setting 4: HDI setting	0	○
P21.19	Digital setting of the positioning speed	Select the positioning speed 0~100.0% of the Max. frequency	20.0%	○
P21.20	Positioning ACC time	Set the ACC/DEC time during the positioning Position ACC time is the interval time accelerating from 0Hz to P00.03	3.00s	○
P21.21	Positioning DEC time	Position DEC time is the interval time decelerating from P00.03 to 0Hz	3.00s	○
P21.22	Hold time of the positioned finished	Set the hold waiting time after arriving to the target position 0.000~60.000s	0.100s	○
P21.23	Origin search speed	Reserved. 0.00~50.00Hz	2.00Hz	○
P21.24	Origin position offset	Reserved. 0~64000	0	○
P21.25	Hold time of positioning complete signal	The hold time of positioning complete signal and also valid to the positioning complete signal of spindle stopping 0.000~60.000s	0.200s	○
P21.26	Reserved			
P21.27	Reserved			

P21.28	ACC/DEC time after pulse prohibition	0.00~300.00s	0.50s	○
P21.29	Filter time constant of speed feedforward	When P0.06=12 or P0.07=12, it is the filter time constant detected by pulse string 0~3200.0ms	10.0ms	○
P21.30	Rigid tapping	0x00~0x31 Ones:Enabling selection 0:Disabled 1:Enabled Tens: Analog port selection 0:Invalid 1:A11 2:A12 3:A13	0x00	⊙
P21.31	Analog filter time of rigid tapping	0.0ms~1000.0ms	1.0ms	○
P21.32	Maximum frequency of rigid tapping	0.0~100.0%	100.0%	○
P22 Spindle positioning				

<p>P22.00</p>	<p>Spindle position mode</p>	<p>0x0000~0xFFFF Bit0: Spindle position enabled 0:Disabled 1: Enabled Bit1: Zero position selection 0: Z pulse input 1: Terminal input Bit2: Zero position search 0:search once 1: search every time Bit3: Correction enable of the reference point 0: Disabled 1: Enabled Bit4: Position mode 1 0: Position at the set direction 1: Position at the nearest direction Bit5: Position mode 2 0: Forward position 1: Reverse position Bit6: Zeroing correction 0: Electric level 1:Pulse Bit7: Correction mode 0: First correction 1: Current correction Bit8: Act after the zeroing signal clearance (valid in electric level mode) 0: Position lock mode 1: Shift to speed mode Bit9:signal selection 0:Electric level signal 1:Pulse signal Bit10:Z pulse source 0:from the motor 1:from the spindle Bit11~15:Reserved</p>	<p>0x0000</p>	<p>○</p>
<p>P22.01</p>	<p>Spindle stop speed</p>	<p>Search the speed at the stopping start point and after finding out the stopping start position, switch to stopping position control 0.00~100.00Hz</p>	<p>10.00 Hz</p>	<p>○</p>

P22.02	Spindle DEC time	The time is when the inverter decelerated from the maximum frequency to 0Hz 0.0~100.0s	3.0s	○
P22.03	Zero position 0	4 zero positions can be selected through the terminal (46 and 47) 0~39999	0	○
P22.04	Zero position 1	0~39999	0	○
P22.05	Zero position 2	0~39999	0	○
P22.06	Zero position 3	0~39999	0	○
P22.07	Scale division angle 1	7 scales can be selected through the terminal (48, 49, and 50) 0.00~359.99	15.00	○
P22.08	Scale division angle 2	0.00~359.99	30.00	○
P22.09	Scale division angle 3	0.00~359.99	45.00	○
P22.10	Scale division angle 4	0.00~359.99	60.00	○
P22.11	Scale division angle 5	0.00~359.99	90.00	○
P22.12	Scale division angle 6	0.00~359.99	120.00	○
P22.13	Scale division angle 7	0.00~359.99	180.00	○
P22.14	Spindle drive ratio	0.000~30.000	1.000	○

P22.15	Zero communication of the spindle	Set the drive ratio of the installation bear of the spindle and encoder 0~39999	0	○
--------	---	---	---	---

7.1 What this chapter contains

This chapter describes the internal function mode of the inverter in details.

	<ul style="list-style-type: none"> ↯ Check all terminals are connected properly and tightly. ↯ Check that the power of the motor corresponds to that of the inverter.
---	---

7.2 First powering on

Check before powering on

Please check according to the installation list in chapter two.

Original powering operation

Check to ensure there is no mistake in wiring and power supply, switch on the air switch of the AC power supply on the input side of the inverter to power on the inverter. **8.8.8.8.8** will be displayed on the keypad, and the contactor closes normally. When the character on the nixie tube changes to the set frequency, the inverter has finished the initialization and it is in the stand-by state.

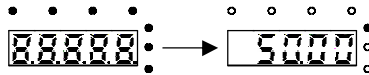

LED displays “8.8.8.8.8” and in the stand-by state, 7 LEDs are on.

Below diagram shows the first operation: (take motor 1 as the example)

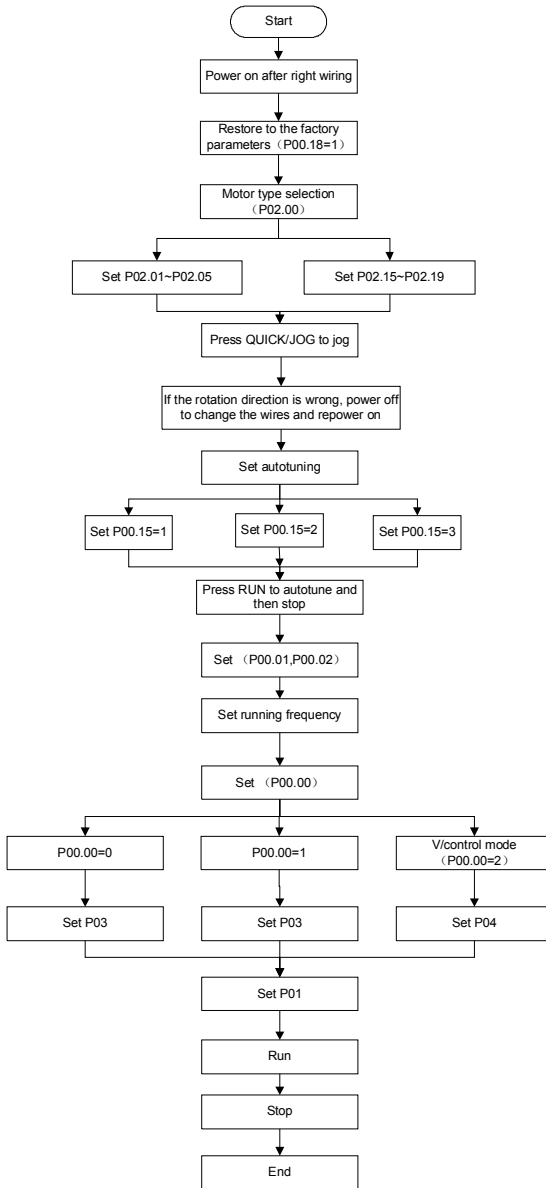

Note: If fault occurs, please do as the “Fault Tracking”. Estimate the fault reason and settle the issue.

Besides P00.01 and P00.02, terminal command setting can also be used to set the running command channel.

Current running command channel P00.01	Multi-function terminal 36 Switch to keypad	Multi-function terminal 37 Switch to terminal	Multi-function terminal 38 Switch to communication
Keypad running command channel	/	Terminal running command channel	Communication running command channel
Terminal running command channel	Keypad running command channel	/	Communication running command channel
Communication running command channel	Keypad running command channel	Terminal running command channel	/

Note: “/” means the multi-function terminal is invalid on the current given channel.

Relative parameters table:

Function code	Name	Detailed instruction of parameters	Default value
P00.00	Speed control mode	0: Sensorless vector control mode 0 (apply to AM and SM) 1: Sensorless vector control mode 1 (applying to AM) 2: SVPWM control	2
P00.01	Run command channel	0: Keypad running command 1: Terminal running command channel (“LOCAL/REMOT” flickering) 2: Communication running command channel (“LOCAL/REMOT” on);	0
P00.02	Communication running commands	0: MODBUS communication channel 1: PROFIBUS\CAN open communication channel	0

Function code	Name	Detailed instruction of parameters	Default value
		2:Ethernet communication channel 3:Reserved	
P00.18	Function restore parameter	0:No operation 1:Restore the default value 2:Cancel the fault record	0
P00.15	Motor parameter autotuning	0:No operation 1:Rotation autotuning 2: Static autotuning 1(autotune totally) 3: Static autotuning 2(autotune part parameters)	0
P02.00	Motor type 1	0:Asynchronous motor 1:Synchronous motor	1
P02.01	Rated power of asynchronous motor 1	0.1~3000.0kW	Depend on model
P02.02	Rated frequency of asynchronous motor 1	0.01Hz~P00.03(the Max. frequency)	50.00Hz
P02.03	Rated speed of asynchronous motor 1	1~36000rpm	Depend on model
P02.04	Rated voltage of asynchronous motor 1	0~1200V	Depend on model
P02.05	Rated current of asynchronous motor 1	0.8~6000.0A	Depend on model
P02.15	Rated power of synchronous motor 1	0.1~3000.0kW	Depend on model
P02.16	Rated frequency of synchronous motor 1	0.01Hz~P00.03(the Max. frequency)	50.00Hz
P02.17	Number of poles pairs for synchronous motor 1	1~128	2
P02.18	Rated voltage of synchronous motor 1	0~1200V	Depend on model

Function code	Name	Detailed instruction of parameters	Default value
P02.19	Rated current of synchronous motor 1	0.8~6000.0A	Depend on model
P05.01~P05.09	Multi-function digital input terminals (S1~S8,HDI) function selection	36:Shift the command to keypad 37:Shift the command to terminals 38:Shift the command to communication	
P07.01	Parameter copy	The function code determines the manner of parameters copy. 0:No operation 1:Upload the local function parameter to the keypad 2:Download the keypad function parameter to local address(including the motor parameters) 3:Download the keypad function parameter to local address (excluding the motor parameter of P02 and P12 group) 4:Download the keypad function parameters to local address (only for the motor parameter of P02 and P12 group)	0
P07.02	QUICK/JOG function selection	0: No function 1: Jogging. Press QUICK/JOG to begin the jogging running. 2: Shift the display state by the shifting key. Press QUICK/JOG to shift the displayed function code from right to left. 3: Shift between forward rotations and reverse rotations. Press QUICK/JOG to shift the direction of the frequency commands. This function is only valid in the keypad commands channels. 4: Clear UP/DOWN settings. Press	1

Function code	Name	Detailed instruction of parameters	Default value
		QUICK/JOG to clear the set value of UP/DOWN. 5: Coast to stop. Press QUICK/JOG to coast to stop. 6: Shift the given manner of running commands. Press QUICK/JOG to shift the given manner of running commands. 7:Quick commission mode(committee according to the non-factory parameter)	

7.3 Vector control

Because asynchronous motors have the characteristics of high stage, nonlinear, strong coupling and various variables, the actual control of the asynchronous motor is very difficult. Vector control is mainly used to settle this problem with the theme of that divide the stator current vector into exciting current (the current heft generating internal magnetic field of the motor) and torque current (the current heft generating torque) by controlling and measuring the stator current vector according to the principles of beamed magnetic field to control the range and phase of these two hefts. This method can realize the decoupling of exciting current and torque current to adjust the high performance of asynchronous motors.

Goodrive35 series inverters are embedded speedless sensor vector control calculation for driving both asynchronous motors and synchronous motors. Because the core calculation of vector control is based on exact motor parameter models, the accuracy of motor parameter will impact on the performance of vector control. It is recommended to input the motor parameters and carry out autotune before vector running.

Because the vector control calculation is vary complicated, high technical theory is needed for the user during internal autotune. It is recommended to use the specific function parameters in vector control with cautions.

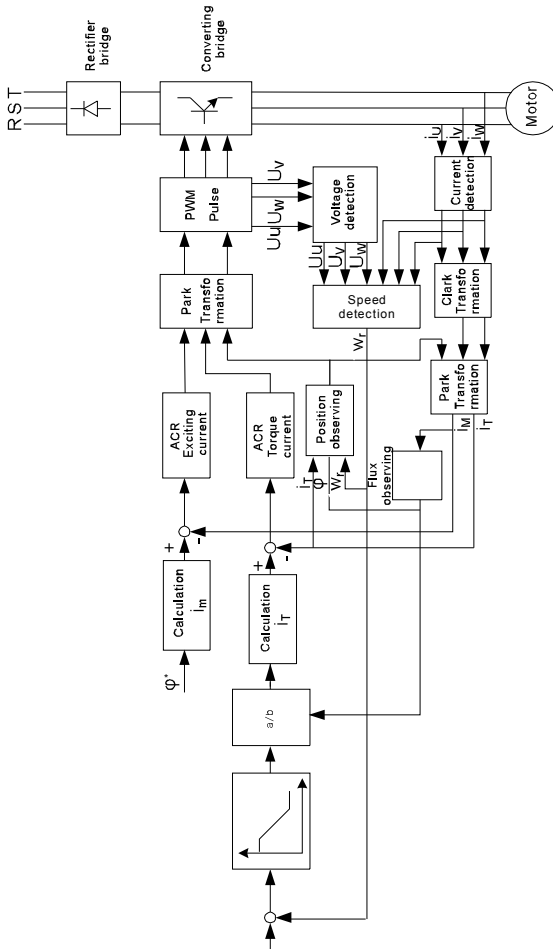

Function code	Name	Detailed instruction of parameters	Default value
P00.00	Speed control mode	0: Sensorless vector control mode 1 1: Sensorless vector control mode 2 2: SVPWM control 3: Close loop vector control mode	2

Function code	Name	Detailed instruction of parameters	Default value
P00.15	Motor parameter autotuning	0:No operation 1:Rotation autotuning 2: Static autotuning 1(autotune totally) 3: Static autotuning 2(autotune part parameters)	0
P02.00	Motor type 1	0:Asynchronous motor 1:Synchronous motor	1
P03.00	Speed loop proportional gain1	0~200.0	16.0
P03.01	Speed loop integral time1	0.000~10.000s	0.200s
P03.02	Low switching frequency	0.00Hz~P03.05	5.00Hz
P03.03	Speed loop proportional gain 2	0~200.0	10.0
P03.04	Speed loop integral time 2	0.000~10.000s	0.200s
P03.05	High switching frequency	P03.02~P00.03(the Max. frequency)	10.00Hz
P03.06	Speed loop output filter	0~8(corresponds to $0\sim 2^8/10\text{ms}$)	0
P03.07	Compensation coefficient of electromotion slip	50%~200%	100%
P03.08	Compensation coefficient of braking slip	50%~200%	100%
P03.09	Current loop percentage coefficient P	0~65535	1000
P03.10	Current loop integral coefficient 1	0~65535	1000
P03.11	Torque setting method	0:Torque control is invalid 1:Keypad setting torque(P03.12) 2:Analog AI1 setting torque 3:Analog AI2 setting torque 4:Analog AI3 setting torque 5:Pulse frequency HDI setting torque	0

Function code	Name	Detailed instruction of parameters	Default value
		6:Multi-step torque setting 7:MODBUS communication setting torque 8:PROFIBUS/CANopen communication setting torque 9:Ethernet communication setting torque 10:Reserved	
P03.12	Keypad setting torque	-300.0%~300.0%(rated current of the motor)	10.0%
P03.13	Torque reference filter time	0.000~10.000s	0.100s
P03.14	Upper frequency of forward rotation in vector control	0:Keypad (P03.16 sets P03.14 and P03.17 sets P03.15) 1: AI1	0
P03.15	Upper frequency of reverse rotation in vector control	2: AI2 3: AI3 4:Pulse frequency HDI setting upper-limit frequency 5:Multi-step setting upper-limit frequency 6:MODBUS communication setting upper-limit frequency 7: PROFIBUS/CANopen communication setting upper-limit frequency 8:Ethernet communication setting upper-limit frequency 9: Reserved	0
P03.16	Keypad setting for upper frequency of forward rotation	Setting range:0.00Hz~P00.03 (the Maximum frequency)	50.00Hz
P03.17	Keypad setting for upper frequency of reverse		50.00Hz

Function code	Name	Detailed instruction of parameters	Default value
	rotation		
P03.18	Upper electromotion torque source	0:Keypad setting upper-limit frequency(P03.20 sets P03.18, P03.21 sets P03.19)	0
P03.19	Upper braking torque source	1: AI1 2: AI2 3: AI3 4: HDI 5:MODBUS communication 6:PROFIBUS/CANopen communication 7:Ethernet communication 8: Reserved	0
P03.20	Keypad setting of electromotion torque	0.0~300.0%(rated current of the motor)	180.0%
P03.21	Keypad setting of braking torque		180.0%
P03.22	Weakening coefficient in constant power zone	0.01~2.00	1.00
P03.23	Lowest weakening point in constant power zone	5%~50%	10%
P03.24	Max. voltage limit	0.0~120.0%	100.0%
P03.25	Pre-exciting time	0.000~10.000s	0.0s
P03.26	Weak proportional gain	0~8000	1200
P03.27	Integral gain of the weak magnetic	0~8000	1200
P03.28	Control mode of the weak magnetic	0x000~0x112 Ones: Control mode selection 0~2 Tens: Inducence compensation selection 0: Compensate 1: Not compensate	0x000

Function code	Name	Detailed instruction of parameters	Default value
		Hundreds: High speed control mode 0: Mode 0 1: Mode 1	
P03.29	Torque control mode	0x0000~0x7111 Ones: Torque command selection 0: Torque reference 1: Torque current reference Tens: Torque compensation direction at 0 speed 0: Positive 1: Negative Hundreds: speed loop integral separation 0: Disabled 1: Enabled Thousands: Torque command filter 0: Inertis filter 1: Linear ACC/DEC filter	0x0001
P03.30	Low-speed friction torque	0~50.0%	0.0%
P03.31	High-speed friction torque	0~50.0%	0.0%
P03.32	Corresponding frequency of high-speed friction torque	1.00 Hz~500.00Hz	50.00Hz

7.4 SVPWM control

Goodrive35 series inverters provide internal SVPWM control which can be used in the cases where it does not need high control accuracy. It is also recommended to use SVPWM control when one inverter drives multiple motors.

Goodrive35 series inverters provide multiple V/F curve modes. The user can select the corresponding V/F curve to the site needs. Or they can set the corresponding V/F curve to their own needs.

Recommendations:

For the load of constant torque, such as the conveyor belt which runs linearly. It is properly to select linear V/F curve because it needs constant torque.

For the load of decreasing torque, such as fans and water pumps, it is properly to select corresponding 1.3th, 1.7th or 2th power of V/F curve because the actual torque is 2-squared or 3-squared of the rotating speed.

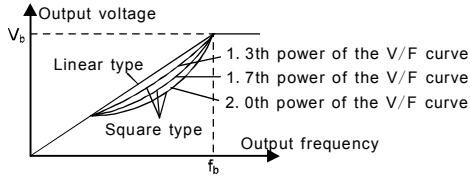

Goodrive35 series inverters provide multi-dots V/F curve, the user can change the output V/F curve by setting the voltage and frequency of three middle dots. The whole curve is consisted of 5 dots. The starting dot is (0Hz, 0V), and the ending dot is (the basic frequency of the motor, the rated voltage of the motor). During the setting processing: $0 \leq f_1 \leq f_2 \leq f_3 \leq$ the basic frequency of the motor; $0 \leq V_1 \leq V_2 \leq V_3 \leq$ the rated voltage of the motor.

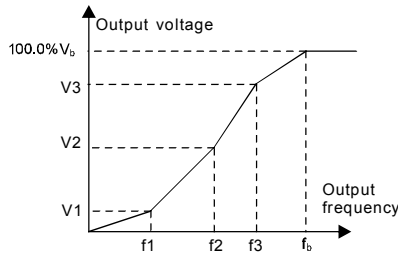

Goodrive35 series inverters provide special function code for SVPWM control mode which can improve the performance of SVPWM control by means of setting.

1. Torque boost

Torque boost function can compensate the performance of low speed torque during SVPWM control. The inverter will adjust the torque boost according to the actual load.

Note:

The torque boost takes effect only when the frequency is under the cap frequency of the boost. If the torque boost is too big, low frequency vibration or overcurrent fault may occur. Please lower the torque boost.

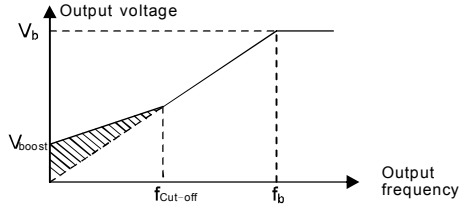

2. Energy-saving running

In the actual operation, the inverter can search by itself to achieve a better effect point. The inverter can work with high effect to save energy.

Note:

This function is usually used in the cases where the load is light or empty.

If the load transients frequently, this function is not appropriate to be selected.

3. V/F slips compensation gain

SVPWM control belongs to the open loop mode. If the load of the motor transients suddenly, the fluctuation of the rotation speed may occur. In the cases where the high accuracy speed is needed, slip compensation gain (internal output adjustment) can be set to compensate the speed change caused by load fluctuation.

Setting range of slip compensation gain: 0~200%, of which 100% corresponds to the rated slip frequency.

Note: Rated slip frequency= (rated synchronous rotation speed of the motor-rated rotation speed of the motor) *number of pole pairs/60.

4. Vibration control

Motor vibration occurs frequently when applying SVPWM control mode in the cases where high power is needed. In order to settle this problem, Goodrive35 series inverters add two function codes which are set to control the vibration factors. The user can set the corresponding function code according to the vibration frequency.

Note: Bigger the set value, more effective is the control. If the set value is too big, overcurrent may occur to the motor.

5. User-defined V/F curve (V/F separation) function

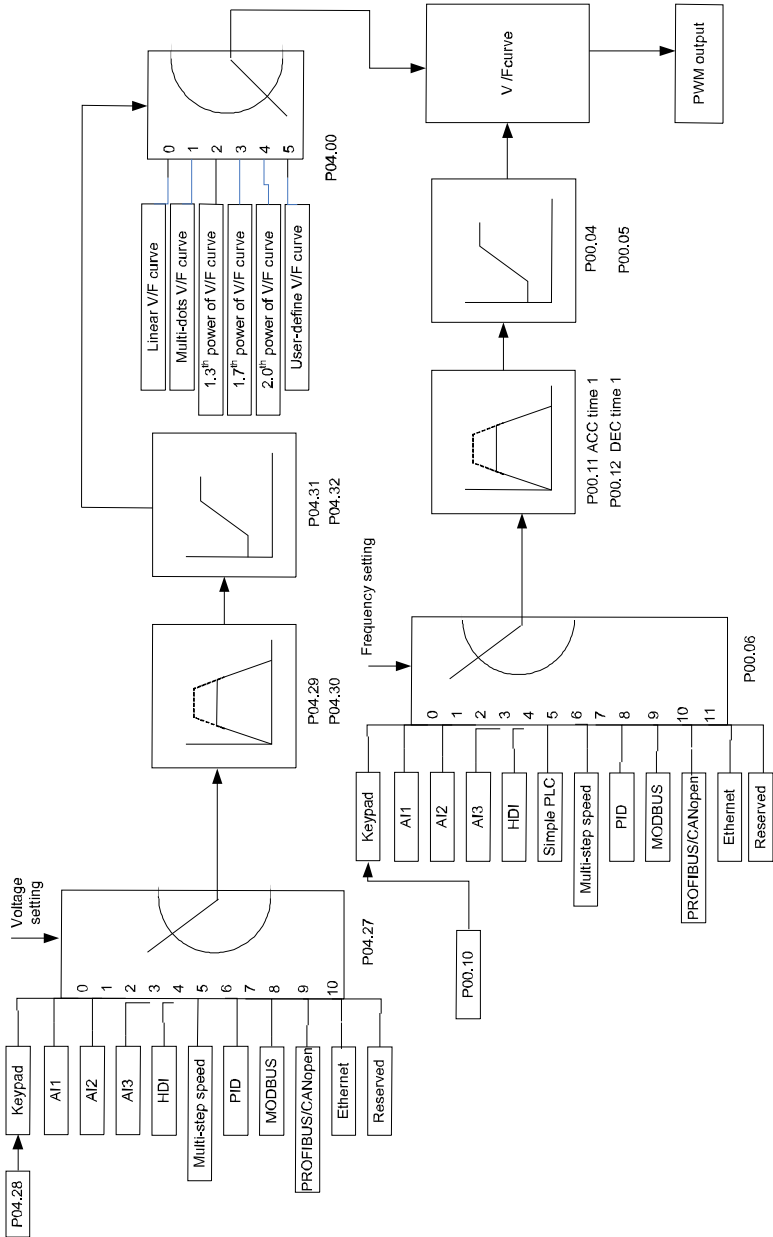

When the user selects the user-defined V/F curve function in Goodrive35 series inverters, they can set the given channel of voltage and frequency and the corresponding ACC/DEC time, or the two can combine to form a real-time curve.

Note: the application of V/F curve separation can be used in many cases with various kinds of power supply of the inverter. But the users should set and adjust the parameters with caution.

Incorrect parameters may cause damage to the inverter.

Function code	Name	Detailed instruction of parameters	Default value
P00.00	Speed control mode	0: Sensorless vector control mode 1 1: Sensorless vector control mode 2 2:SVPWM control 3: Close loop vector control mode	2
P00.03	Max. output frequency	P00.04~400.00Hz	50.00Hz
P00.04	Upper limit of the running frequency	P00.05~P00.03	50.00Hz
P00.05	Lower limit of the running frequency	0.00Hz~P00.04	0.00Hz
P00.11	ACC time 1	0.0~3600.0s	Depend on model
P00.12	DEC time 1	0.0~3600.0s	Depend on model
P02.00	Motor type 1	0:Asynchronous motor 1:Synchronous motor	1
P02.02	Rated frequency of asynchronous motor 1	0.01Hz~P00.03(Max frequency)	50.00
P02.04	Rated voltage of asynchronous motor 1	0~1200V	Depend on model
P04.00	Motor 1V/F curve setting	0: Straight line V/F curve; applying to the constant torque load 1: Multi-dots V/F curve 2: 1.3 th power low torque V/F curve 3: 1.7 th power low torque V/F curve 4: 2.0 th power low torque V/F curve 5: Customized V/F(V/F separation)	0

Function code	Name	Detailed instruction of parameters	Default value
P04.01	Torque boost of motor 1	0.0%:(automatic) 0.1%~10.0%	0.0%
P04.02	Torque boost close of motor 1	0.0%~50.0%(the rated frequency of motor 1)	20.0%
P04.03	V/F frequency 1 of motor 1	0.00Hz~P04.05	0.00Hz
P04.04	V/F voltage 1 of motor 1	0.0%~110.0%	00.0%
P04.05	V/F frequency 2 of motor 1	P04.03~ P04.07	00.00Hz
P04.06	V/F voltage 2 of motor 1	0.0%~110.0%	00.0%
P04.07	V/F frequency 3 of motor 1	P04.05~P02.02 or P04.05~P02.16	00.00Hz
P04.08	V/F voltage 3 of motor 1	0.0%~110.0%	00.0%
P04.09	V/F slip compensation gain of motor 1	0.0~200.0%	100.0%
P04.10	Vibration control factor at low frequency of motor 1	0~100	10
P04.11	Vibration control factor at high frequency of motor 1	0~100	10
P04.12	Vibration control threshold of motor 1	0.00Hz~P00.03 (the Max. frequency)	30.00 Hz
P04.13	Motor 2 V/F curve setting	0: Straight line V/F curve; applying to the constant torque load 1: Multi-dots V/F curve 2: 1.3 th power low torque V/F curve 3: 1.7 th power low torque V/F curve 4: 2.0 th power low torque V/F curve 5: Customized V/F(V/F separation)	0
P04.14	Torque boost of motor 2	0.0%: (automatic) 0.1%~10.0%	0.0%

Function code	Name	Detailed instruction of parameters	Default value
P04.15	Torque boost close of motor 2	0.0%~50.0%(rated frequency of motor 1)	20.0%
P04.16	V/F frequency 1 of motor 2	0.00Hz~P04.05	0.00Hz
P04.17	V/F voltage 1 of motor 2	0.0%~110.0%	00.0%
P04.18	V/F frequency 2 of motor 2	P04.16~ P04.20	00.00Hz
P04.19	V/F voltage 2 of motor 2	0.0%~110.0%	00.0%
P04.20	V/F frequency 3 of motor 2	P04.18~ P12.02 or P04.18~ P12.16	00.00Hz
P04.21	V/F voltage 3 of motor 2	0.0%~110.0%	00.0%
P04.22	V/F slip compensation gain of motor 2	0.0~200.0%	100.0%
P04.23	Vibration control factor at low frequency of motor 2	0~100	10
P04.24	Vibration control factor at high frequency of motor 2	0~100	10
P04.25	Vibration control threshold of motor 2	0.00Hz~P00.03 (the Max. frequency)	30.00 Hz
P04.26	Energy-saving operation	0: No action 1: Automatic energy-saving running	0
P04.27	Voltage setting	0: Keypad: the output voltage is determined by P04.28. 1:A11; 2:A12; 3:A13; 4:HDI1; 5:Multi-step speed; 6:PID;	0

Function code	Name	Detailed instruction of parameters	Default value
		7:MODBUS communication; 8:PROFIBUS/CANopen communication; 9:Ethernet communication; 10: Reserved	
P04.28	Keypad setting voltage	0.0%~100.0% (the rated voltage of motor)	100.0%
P04.29	Voltage increasing time	0.0~3600.0s	5.0s
P04.30	Voltage decreasing time	0.0~3600.0s	5.0s
P04.31	Maximum output voltage	P04.32~100.0%(the rated voltage of motor)	100.0%
P04.32	Minimum output voltage	0.0%~P04.31 (the rated voltage of motor)	0.0%

7.5 Torque control

Goodrive35 series inverters support two kinds of control mode: torque control and rotation speed control. The core of rotation speed is that the whole control focuses on the stable speed and ensures the setting speed is the same as the actual running speed. The Max. Load should be in the range of the torque limit. The core of torque control is that the whole control focus on the stable torque and ensures the setting torque is the same as the actual output torque. At the same time, the output frequency is among the upper limit or the lower limit.

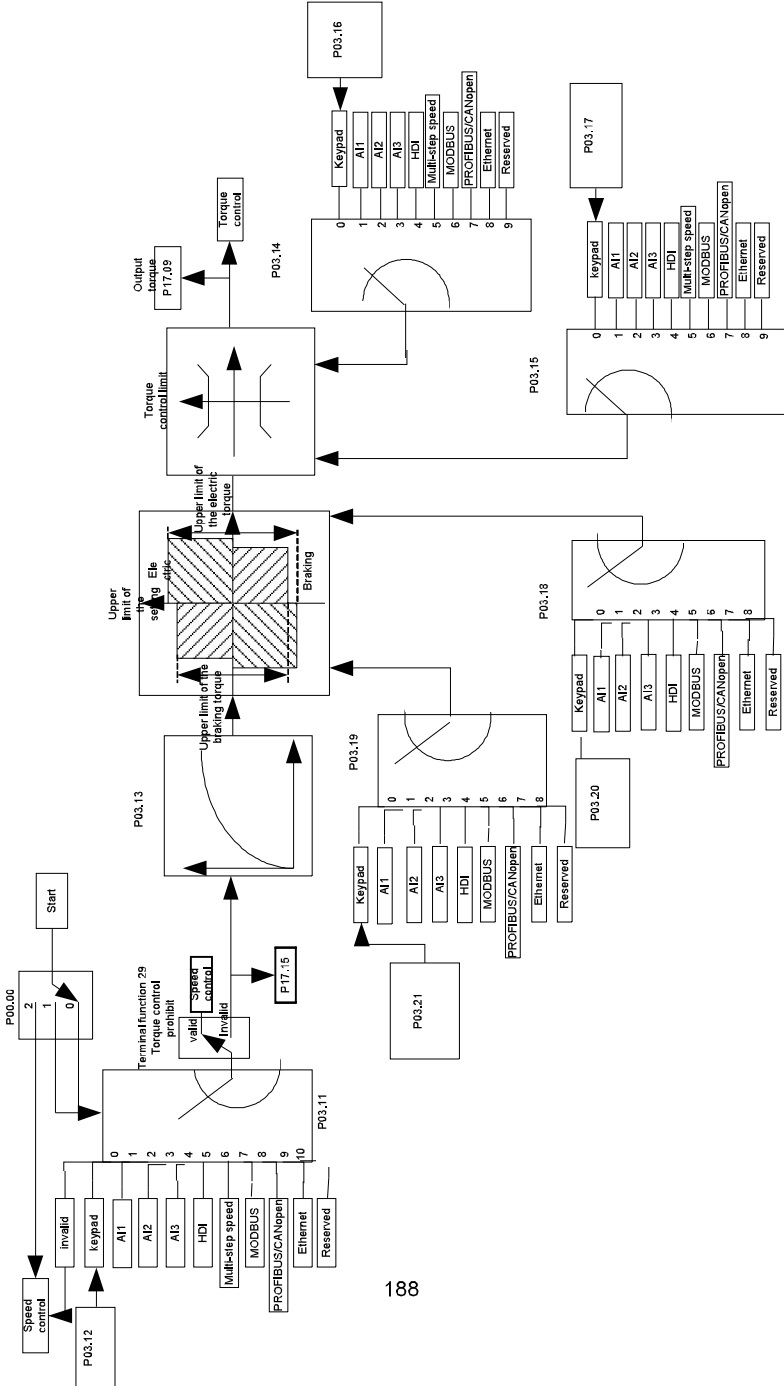

Function code	Name	Detailed instruction of parameters	Default value
P00.00	Speed control mode	0: Sensorless vector control mode 1 1: Sensorless vector control mode 2 2:SVPWM control 3: Close loop vector control mode	2
P03.11	Torque setting method	0:Torque control is invalid 1:Keypad setting torque(P03.11) 2:Analog AI1 setting torque 3:Analog AI2 setting torque 4:Analog AI3 setting torque 5:Pulse frequency HDI setting torque 6:Multi-step torque setting 7:MODBUS communication setting torque 8:PROFIBUS/CANopen communication setting torque 9:Ethernet communication setting torque 10:Reserved	0
P03.12	Keypad setting torque	-300.0%~300.0% (the rated current of the motor)	10.0%
P03.13	Torque reference filter time	0.000~10.000s	0.100s
P03.14	Upper frequency of forward rotation in vector control	0:Keypad (P03.16 sets P03.14,P03.17 sets P03.15) 1: AI1	0
P03.15	Upper frequency of reverse rotation in vector control	2: AI2 3: AI3 4:Pulse frequency HDI setting upper-limit frequency 5:Multi-step setting upper-limit frequency 6:MODBUS communication setting upper-limit frequency 7:PROFIBUS/CANopen communication setting upper-limit frequency	0

Function code	Name	Detailed instruction of parameters	Default value
		8:Ethernet communication setting upper-limit frequency 9: Reserved	
P03.16	Keypad setting for upper frequency of forward rotation	0.00Hz~P00.03 (the Max. frequency)	50.00 Hz
P03.17	Keypad setting for upper frequency of reverse rotation	0.00 Hz~P00.03 (the Max. frequency)	50.00 Hz
P03.18	Upper electromotion torque source	0:Keypad setting upper-limit frequency(P03.20 sets P03.18, P03.21 sets P03.19) 1: AI1 2: AI2	0
P03.19	Upper braking torque source	3: AI3 4: HDI 5:MODBUS communication 6:PROFIBUS/CANopen communication 7:Ethernet communication 8: Reserved	0
P03.20	Keypad setting of electromotion torque	0.0~300.0%(rated current of the motor)	180.0%
P03.21	Keypad setting of braking torque	0.0~300.0%(rated current of the motor)	180.0%
P17.09	Output torque	-250.0~250.0%	0.0%
P17.15	Torque reference	-300.0~300.0%(rated current of the motor)	0.0%

7.6 Parameters of the motor

	<p>↷Physical accident may occur if the motor starts up suddenly during autotune. Please check the safety of surrounding environment of the motor and the load before autotune.</p>
---	--

motors can autotune the parameters of P02.20~P02.23.

3. During the motor autotune, do not to de-couple the motor form the load if static autotune is selected. Because only some parameters of the motor are involved, the control performance is not as better as the rotation autotune. The asynchronous motors can autotune the parameters of P02.06~P02.10, while the synchronous motors can autotune the parameters of P02.20~P02.22. P02.23 (synchronous motor 1 counter-electromotive force constant) can be counted to attain.

4. Motor autotune only involves the current motor. Switch the motor through P08.31 to carry out the autotune on the other motor.

Relative parameters list:

Function code	Name	Detailed instruction of parameters	Default value
P00.01	Run command channel	0:Keypad running command(LED off) 1:Terminal running command channel (LED flickering) 2:Communication running command channel (LED on)	0
P00.15	Motor parameter autotuning	0:No operation 1:Rotation autotuning 2: Static autotuning 1 (autotune totally) 3: Static autotuning 2 (autotune part parameters)	0
P02.00	Motor 1	0:Asynchronous motor 1:Synchronous motor	1
P02.01	Rated power of asynchronous motor 1	0.1~3000.0kW	Depend on model
P02.02	Rated frequency of asynchronous motor 1	0.01Hz~P00.03(the Max frequency)	50.00Hz
P02.03	Rated speed of asynchronous motor 1	1~36000rpm	Depend on model
P02.04	Rated voltage of asynchronous motor 1	0~1200V	Depend on model
P02.05	Rated current of asynchronous motor 1	0.8~6000.0A	Depend on model
P02.06	Stator resistor of asynchronous motor 1	0.001~65.535Ω	Depend on model
P02.07	Rotor resistor of	0.001~65.535Ω	Depend

The control performance of the inverter is based on the established accurate motor model. The user has to carry out the motor autotune before first running (take motor 1 as the example).

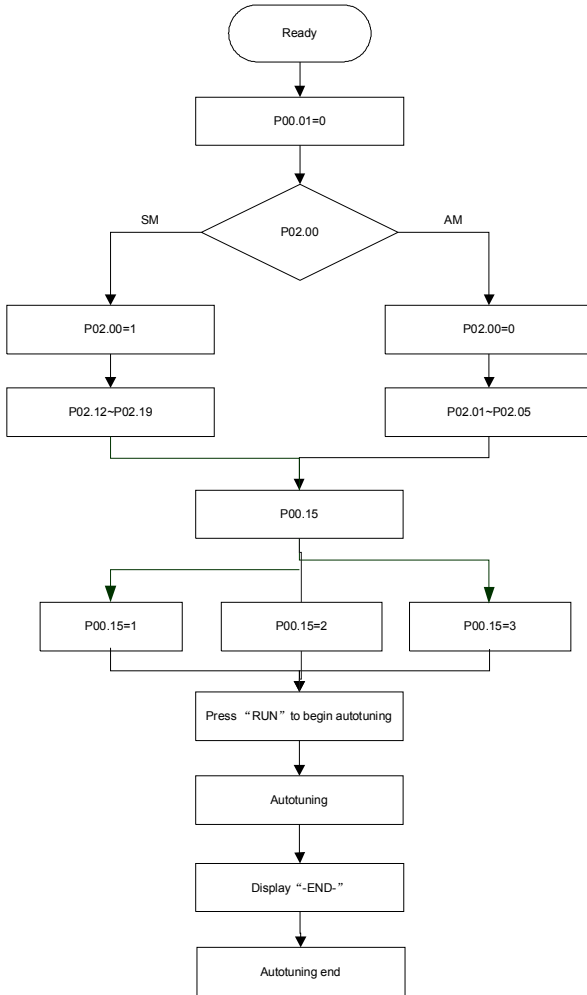

Note:

1. Set the motor parameters according to the name plate of the motor.
2. During the motor autotune, de-couple the motor from the load if rotation autotune is selected to make the motor is in a static and empty state, otherwise the result of autotune is incorrect. The asynchronous motors can autotune the parameters of P02.06~P02.10, while the synchronous

	<p>⚡The power is still applied even the motor stops running during static autotune. Please do not touch the motor until the autotune is completed, otherwise there would be electric shock.</p>
	<p>⚡Do not carry out the rotation autotune if the motor is coupled with the load, please do not operate on the rotation autotune. Otherwise misaction or damage may occur to the inverter or the mechanical devices. When carry out autotune on the motor which is coupled with load, the motor parameter won't be counted correctly and misaction may occur. It is proper to de-couple the motor from the load during autotune when necessary.</p>

Goodrive35 series inverters can drive both asynchronous motors and synchronous motors. And at the same time, they can support two sets of motor parameters which can shift between two motors through multi-function digital input terminal or communication.

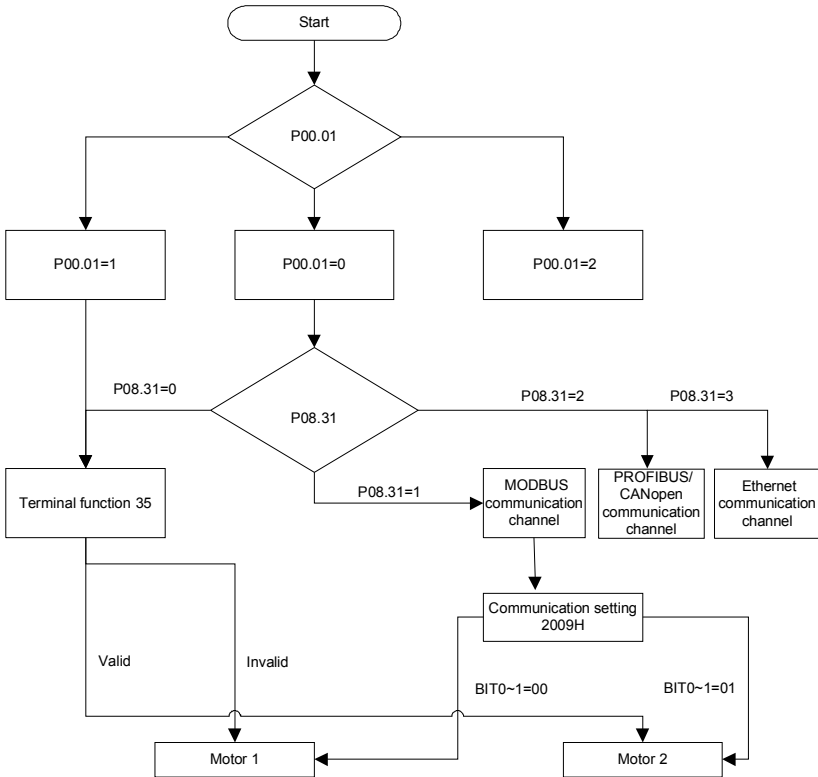

Function code	Name	Detailed instruction of parameters	Default value
	asynchronous motor 1		on model
P02.08	Leakage inductance of asynchronous motor 1	0.1~6553.5mH	Depend on model
P02.09	Mutual inductance of asynchronous motor 1	0.1~6553.5mH	Depend on model
P02.10	Non-load current of asynchronous motor 1	0.1~6553.5A	Depend on model
P02.15	Rated power of synchronous motor 1	0.1~3000.0kW	Depend on model
P02.16	Rated frequency of synchronous motor 1	0.01Hz~P00.03(the Max. frequency)	50.00Hz
P02.17	Number of poles pairs for synchronous motor 1	1~128	2
P02.18	Rated voltage of synchronous motor 1	0~1200V	Depend on model
P02.19	Rated current of synchronous motor 1	0.8~6000.0A	Depend on model
P02.20	Stator resistor of synchronous motor 1	0.001~65.535Ω	Depend on model
P02.21	Direct axis inductance of synchronous motor 1	0.01~655.35mH	Depend on model
P02.22	Quadrature axis inductance of synchronous motor 1	0.01~655.35mH	Depend on model
P02.23	Back EMF constant of synchronous motor 1	0~10000	300
P05.01~P05.09	Multi-function digital input terminals (S1~S8, HDI) function selection	35: Shift from motor 1 to motor 2	
P08.31	Motor shifting	0: Terminal shifting; digital terminal is 35 1: MODBUS communication shifting 2: PROFIBUS/CANopen communication shifting	0

Function code	Name	Detailed instruction of parameters	Default value
P12.00	Motor 2	0: Asynchronous motor 1: Synchronous motor	1
P12.01	Rated power of asynchronous motor 2	0.1~3000.0kW	Depend on model
P12.02	Rated frequency of asynchronous motor 2	0.01Hz~P00.03(the Max. frequency)	50.00Hz
P12.03	Rated speed of asynchronous motor 2	1~36000rpm	Depend on model
P12.04	Rated voltage of asynchronous motor 2	0~1200V	Depend on model
P12.05	Rated current of asynchronous motor 2	0.8~6000.0A	Depend on model
P12.06	Stator resistor of asynchronous motor 2	0.001~65.535Ω	Depend on model
P12.07	Rotor resistor of asynchronous motor 2	0.001~65.535Ω	Depend on model
P12.08	Leakage inductance of asynchronous motor 2	0.1~6553.5mH	Depend on model
P12.09	Mutual inductance of asynchronous motor 2	0.1~6553.5mH	Depend on model
P12.10	Non-load current of asynchronous motor 2	0.1~6553.5A	Depend on model
P12.15	Rated power of synchronous motor 2	0.1~3000.0kW	Depend on model
P12.16	Rated frequency of synchronous motor 2	0.01Hz~P00.03(the Max. frequency)	50.00Hz
P12.17	Number of poles pairs for synchronous motor 2	1~128	2
P12.18	Rated voltage of synchronous motor 2	0~1200V	Depend on model
P12.19	Rated current of synchronous motor 2	0.8~6000.0A	Depend on model
P12.20	Stator resistor of synchronous motor 2	0.001~65.535Ω	Depend on model

Function code	Name	Detailed instruction of parameters	Default value
P12.21	Direct axis inductance of synchronous motor 2	0.01~655.35mH	Depend on model
P12.22	Quadrature axis inductance of synchronous motor 2	0.01~655.35mH	Depend on model
P12.23	Back EMF constant of synchronous motor 2	0~10000	300

7.7 Start-up and stop control

The start-up and stop control of the inverter includes three states: start after the running command during normal powering on, start after the restarting function becomes valid during normal powering on and start after the automatic fault reset. Below is the detailed instruction for three starting.

There are three starting modes for the inverter: start from the starting frequency directly, start after the AC braking and start after the rotation speed tracking. The user can select according to different situations to meet their needs.

For the load with big inertia, especially in the cases where the reverse rotation may occur, it is better to select starting after DC braking and then starting after rotation speed tracking.

Note: It is recommended to use the direct starting to drive synchronous motor.

The starting logic figure of starting after the running command during the normal powering on.

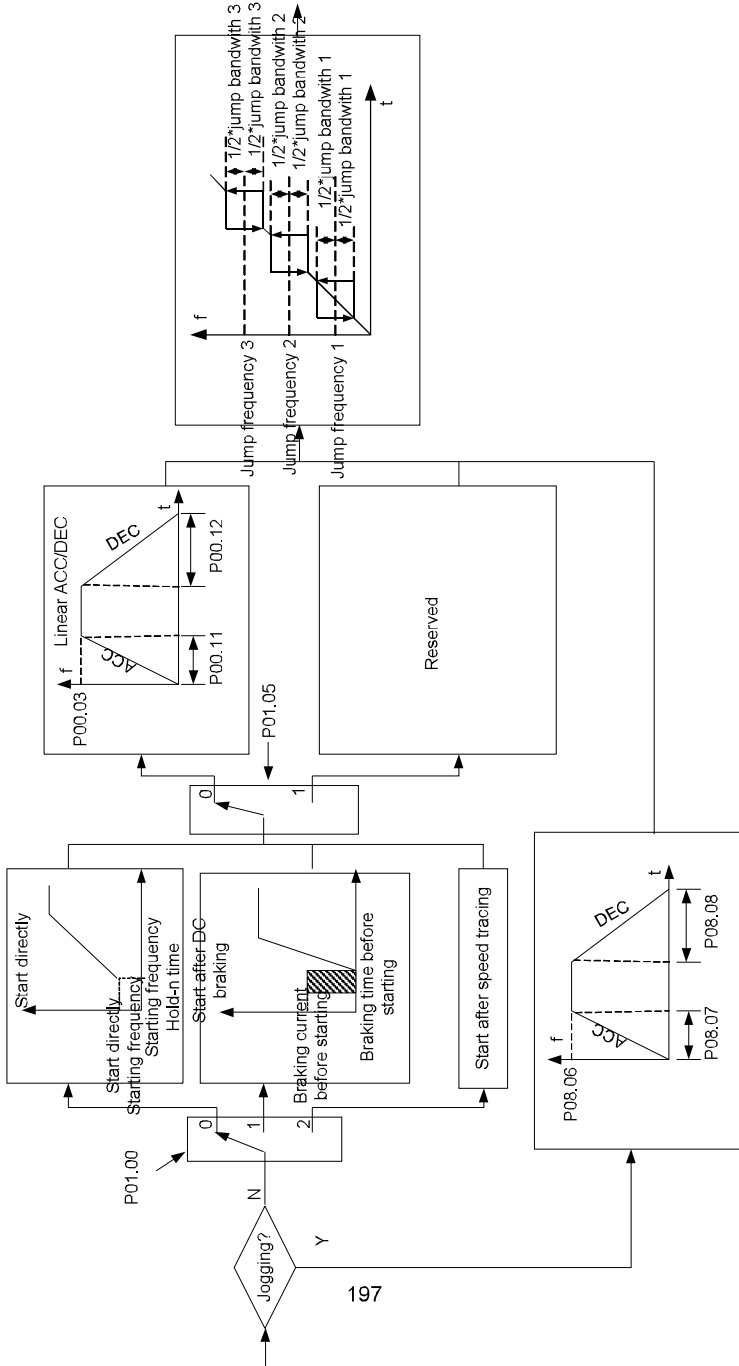

2. The starting logic figure of starting after the restarting function becomes valid during the normal powering on.

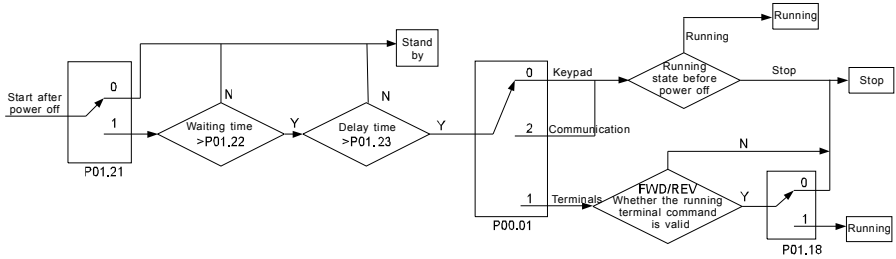

3. The starting logic figure of starting after the automatic fault reset.

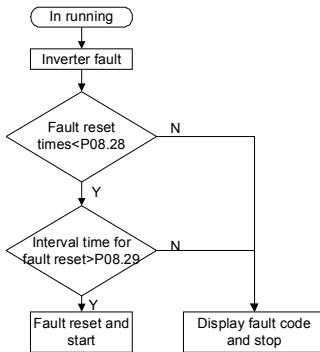

Relative parameters list:

Function code	Name	Detailed instruction of parameters	Default value
P00.01	Run command channel	0:Keypad running command(LED off) 1:Terminal running command channel (LED flickering) 2:Communication running command channel (LED on)	0
P00.11	ACC time 1	0.0~3600.0s	Depend on model
P00.12	DEC time 1	0.0~3600.0s	Depend on model
P01.00	Start mode	0:Start-up directly 1:Start-up after DC braking 2: Start-up after rotation speed tracking 1	0
P01.01	Starting frequency of direct start	0.00~50.00Hz	0.00Hz
P01.02	Retention time of the starting frequency	0.0~50.00s	0.00s
P01.03	The braking current before starting	0.0~100.0%	0.0%
P01.04	The braking time before starting	0.0~30.0s	0.0s
P01.05	ACC/DEC selection	0:Linear type 1: S curve	0
P01.08	Stop mode	0:Decelerate to stop 1:Coast to stop	0
P01.09	Starting frequency of DC braking	0.00Hz~P00.03(the Max. frequency)	0.00Hz
P01.10	Waiting time of DC braking	0.00~30.00s	0.00s
P01.11	DC braking current	0.0~100.0%	0.0%
P01.12	DC braking time	0.0~50.0s	0.0s
P01.13	Dead time of FWD/REV rotation	0.0~3600.0s	0.0s
P01.14	Shifting between	0:Switch after zero frequency	0

Function code	Name	Detailed instruction of parameters	Default value
	FWD/REV rotation	1:Switch after the starting frequency 2:Switch after the stopping speed and delay	
P01.15	Stopping speed	0.00~100.00Hz	0.20 Hz
P01.16	Detection of stopping speed	0: Speed setting (the only detection method in SVPWM mode) 1: Speed detecting value	0
P01.18	Terminal running protection when powering on	0:The terminal running command is invalid when powering on 1: The terminal running command is valid when powering on	0
P01.19	Action if running frequency< lower limit frequency (valid >0)	0: Run at the lower-limit frequency 1: Stop 2: Hibernation 3: Run at zero frequency	0
P01.20	Hibernation restore delay time	0.0~3600.0s (valid when P01.19=2)	0.0s
P01.21	Restart after power off	0: Disable 1: Enable	0
P01.22	The waiting time of restart after power off	0.0~3600.0s(valid when P01.21=1)	1.0s
P01.23	Start delay time	0.00~60.00s	0.00s
P01.24	Delay time of the stopping speed	0.00~60.00s	0.00s
P05.01~P05.09	Digital input function selection	1: Forward rotation operation 2: Reverse rotation operation 4: Forward rotation jogging 5: Reverse rotation jogging 6: Coast to stop 7: Fault reset 8: Operation pause 21:ACC/DEC time option 1 22:ACC/DEC time option 2 30:ACC/DEC prohibition	

Function code	Name	Detailed instruction of parameters	Default value
P08.06	Jogging frequency	0.00~P00.03(the Max. frequency)	5.00Hz
P08.07	Jogging ACC time	0.0~3600.0s	Depend on model
P08.08	Jogging DEC time	0.0~3600.0s	Depend on model
P08.00	ACC time 2	0.0~3600.0s	Depend on model
P08.01	DEC time 2	0.0~3600.0s	Depend on model
P08.02	ACC time 3	0.0~3600.0s	Depend on model
P08.03	DEC time 3	0.0~3600.0s	Depend on model
P08.04	ACC time 4	0.0~3600.0s	Depend on model
P08.05	DEC time 4	0.0~3600.0s	Depend on model
P08.28	Fault reset times	0~10	0
P08.29	Interval time of automatic fault reset	0.1~3200.0s	1.0s

7.8 Frequency setting

Goodrive35 series inverters can set the frequency by various means. The given channel can be divided into main given channel and assistant given channel.

There are two main given channels: A frequency given channel and B frequency given channel. These two given channels can carry out mutual simple math calculation between each other. And the given channels can be shifted dynamically through set multi-function terminals.

There are three assistant given channels: keypad UP/DOWN input, terminals UP/DOWN switch input and digital potentiometer input. The three ways equal to the effect of input UP/DOWN given in internal assistant given of the inverter. The user can enable the given method and the effect of the method to the frequency given by setting function codes.

The actual given of the inverter is consisted of main given channel and assistant given channel.

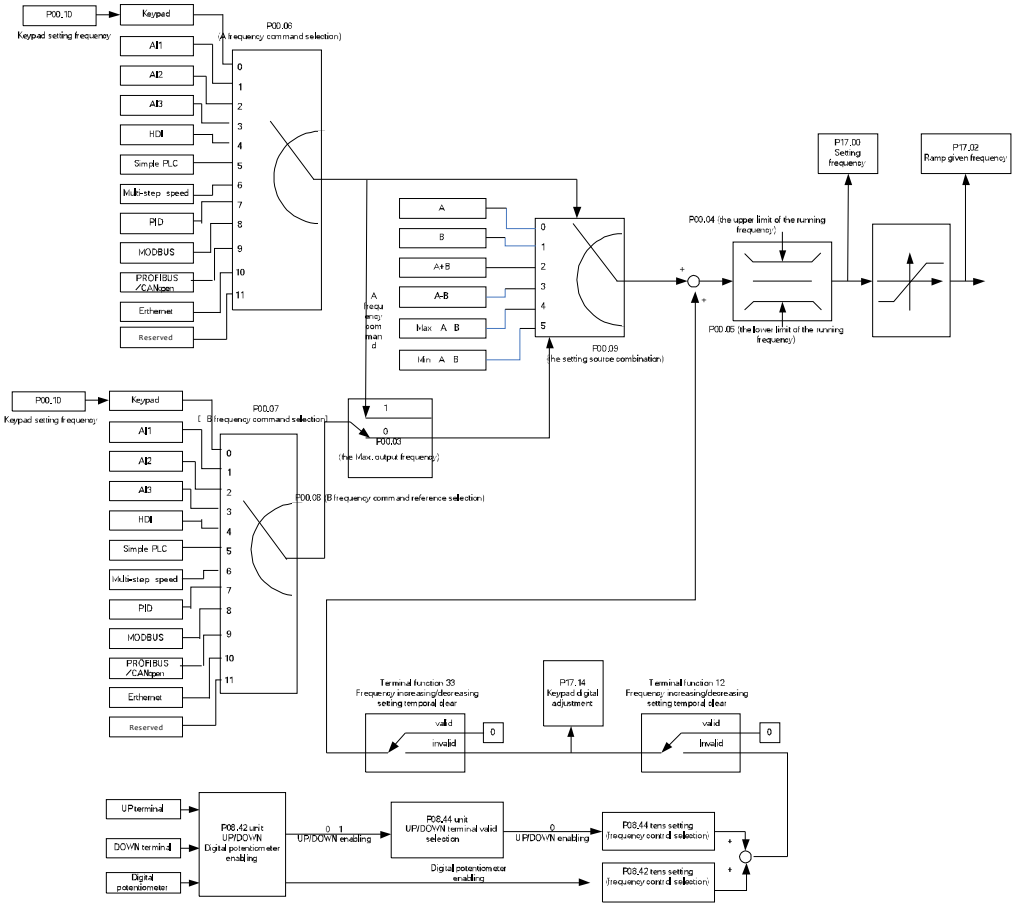

Goodrive35 series inverters support the shifting between different given channels, and the detailed shifting rules is as below:

Current reference channel P00.09	Multi-function terminal function 13 Switch from A channel to B channel	Multi-function terminal function 14 Switch from combination setting to A channel	Multi-function terminal function 15 Switch from combination setting to B channel
A	B	/	/
B	/	/	/
A+B	/	A	B
A-B	/	A	B
Max(A,B)	/	A	B
Min(A,B)	/	A	B

Note: "/" means the multi-function terminal is invalid under the current given channel.

When select multi-function terminal UP (10) and DOWN (11) to set the internal assistant frequency, P08.44 and P08.45 can be set to increase or decrease the set frequency quickly.

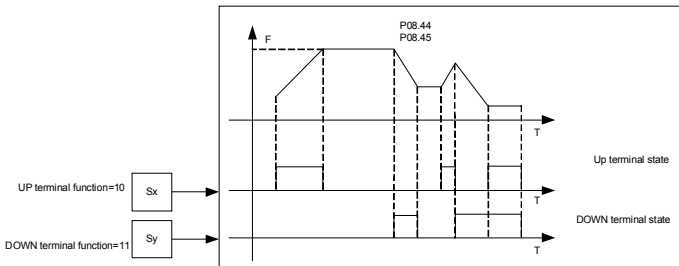

Relative parameters list:

Function code	Name	Detailed instruction of parameters	Default value
P00.03	Max. output frequency	P00.04~400.00Hz	50.00Hz
P00.04	Upper limit of the running frequency	P00.05~P00.03	50.00Hz
P00.05	Lower limit of the running frequency	0.00Hz~P00.04	0.00Hz
P00.06	A frequency command	0:Keypad	0
P00.07	B frequency command	1: AI1 2: AI2 3: AI3 4:High-speed pulse HDI setting 5:Simple PLC program setting 6: Multi-step speed running setting 7: PID control setting 8:MODBUS communication setting 9:PROFIBUS/CANopen communication setting 10:Ethernet communication setting(reserved) 11:Reserved	2
P00.08	B frequency command reference	0: Maximum output frequency 1: A frequency command	0
P00.09	Combination of the setting source	0:A 1:B 2:(A+B)combination 3:(A-B)combination 4:Max(A,B)combination 5:Min(A,B)combination	0
P05.01~P05.09	Multi-function digital input terminals (S1~S8,HDI) function selection	10:Increasing frequency setting (UP) 11:Decreasing frequency setting (DOWN) 12:Cancel the frequency change setting 13:Shift between A setting and B setting 14:Shift between combination setting	

Function code	Name	Detailed instruction of parameters	Default value
		and A setting 15:Shift between combination setting and B setting	
P08.42	Keypad data control	0x000~0x1223 LED ones: frequency enable selection 0:Both \wedge/\vee keys and digital potentiometer adjustments are valid 1:Only \wedge/\vee keys adjustment is valid 2:Only digital potentiometer adjustments is valid 3:Neither \wedge/\vee keys nor digital potentiometer adjustments are valid LED tens: frequency control selection 0:Only valid when P00.06=0 or P00.07=0 1:Valid for all frequency setting manner 2:Invalid for multi-step speed when multi-step speed has the priority LED hundreds: action selection during stopping 0:Setting is valid 1:Valid during running, cleared after stopping 2:Valid during running, cleared after receiving the stop command LED thousands: \wedge/\vee keys and digital potentiometer Integral function 0:The Integral function is valid 1:The Integral function is invalid	0x0000
P08.43	Integral ratio of the keypad potentiometer	0.01~10.00Hz/s	0.10 Hz/s
P08.44	UP/DOWN terminals control	0x00~0x221 LED ones: frequency control selection	0x0000

Function code	Name	Detailed instruction of parameters	Default value
		0:UP/DOWN terminals setting valid 1:UP/DOWN terminals setting valid LED tens: frequency control selection 0:Only valid when P00.06=0 or P00.07=0 1:All frequency means are valid 2:When the multi-step are priority, it is invalid to the multi-step LED hundreds: action selection when stop 0:Setting valid 1: Valid in the running, clear after stop 2: Valid in the running, clear after receiving the stop commands	
P08.45	UP terminals frequency changing ratio	0.01~50.00 Hz/s	0.50 Hz/s
P08.46	DOWN terminals frequency changing ratio	0.01~50.00 Hz/s	0.50 Hz/s
P17.00	Setting frequency	Display current set frequency of the inverter Range: 0.00Hz~P00.03	0.00Hz
P17.02	Ramp reference frequency	Display current ramp given frequency of the inverter Range: 0.00Hz~P00.03	0.00Hz
P17.14	Digital adjustment	Display the adjustment through the keypad of the inverter. Range : 0.00Hz~P00.03	0.00Hz

7.9 Analog input

Goodrive35 series inverters have three analog input terminals and 1 high-speed pulse input terminals (of which, AI1 and AI2 are 0~10V/0~20mA and AI can select voltage input or current input by J1, AI2 can select voltage input or current input by J2 and AI3 is for -10~10V) as the standard configuration. The inputs can be filtered and the maximum and minimum values can be adjusted.

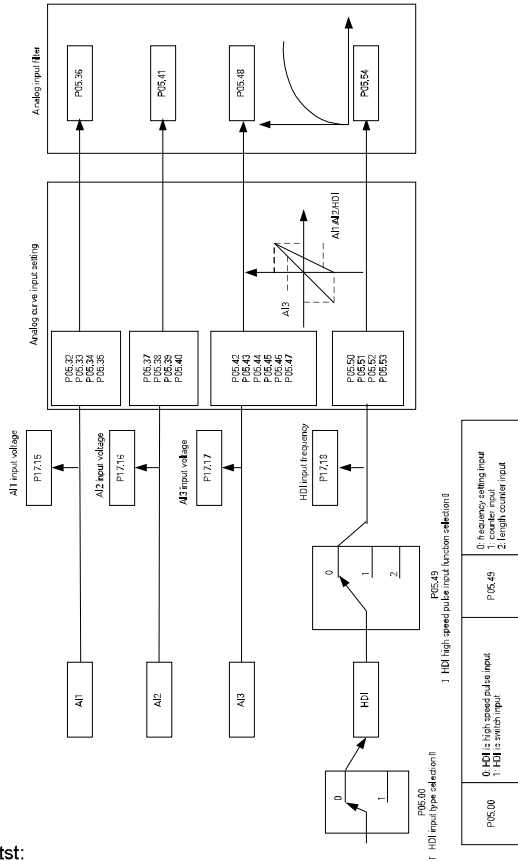

Relative parameters list:

Function code	Name	Detailed instruction of parameters	Default value
P05.00	HDI input selection	0: High pulse input 1: Digital input.	0
P05.32	Lower limit of AI1	0.00V~P05.25	0.00V
P05.33	Corresponding setting of the lower limit of AI1	-300.0%~300.0%	0.0%
P05.34	Upper limit of AI1	P05.23~10.00V	10.00V
P05.35	Corresponding setting of the upper limit of AI1	-300.0%~300.0%	100.0%
P05.36	AI1 input filter time	0.000s~10.000s	0.030s

Function code	Name	Detailed instruction of parameters	Default value
P05.37	Lower limit of AI2	0.00V~P05.30	0.00V
P05.38	Corresponding setting of the lower limit of AI2	-300.0%~300.0%	0.0%
P05.39	Upper limit of AI2	P05.28~10.00V	10.00V
P05.40	Corresponding setting of the upper limit of AI2	-300.0%~300.0%	100.0%
P05.41	AI2 input filter time	0.000s~10.000s	0.030s
P05.42	Lower limit of AI3	-10.00V~P05.35	-10.00V
P05.43	Corresponding setting of the lower limit of AI3	-300.0%~300.0%	-100.0%
P05.44	Middle value of AI3	P05.33~P05.37	0.00V
P05.45	Corresponding middle setting of AI3	-300.0%~300.0%	0.0%
P05.46	Upper limit of AI3	P05.35~10.00V	10.00V
P05.47	Corresponding setting of the upper limit of AI3	-300.0%~300.0%	100.0%
P05.48	AI3 input filter time	0.000s~10.000s	0.030s
P05.49	HDI high-speed pulse input function selection	0:Frequency setting input, frequency setting source 1:Counter input, high-speed pulse counter input terminals 2:Length counting input, length counter input terminals	0
P05.50	Lower limit frequency of HDI	0.00 kHz ~ P05.43	0.00kHz
P05.51	Corresponding setting of HDI low frequency setting	-300.0%~300.0%	0.0%
P05.52	Upper limit frequency of HDI	P05.41~50.00kHz	50.00kHz
P05.53	Corresponding setting of upper limit frequency of HDI	-300.0%~300.0%	100.0%

Function code	Name	Detailed instruction of parameters	Default value
P05.54	HDI frequency input filter time	0.000s~10.000s	0.030s

7.10 Analog output

Goodrive35 series inverters have 2 analog output terminals (0~10V or 0~20mA) and 1 high speed pulse output terminal. Analog output signal can be filtered and the maximum and minimum values can be adjusted. The analog output signals can be proportional to motor speed, output frequency, output current, motor torque, motor power, etc.

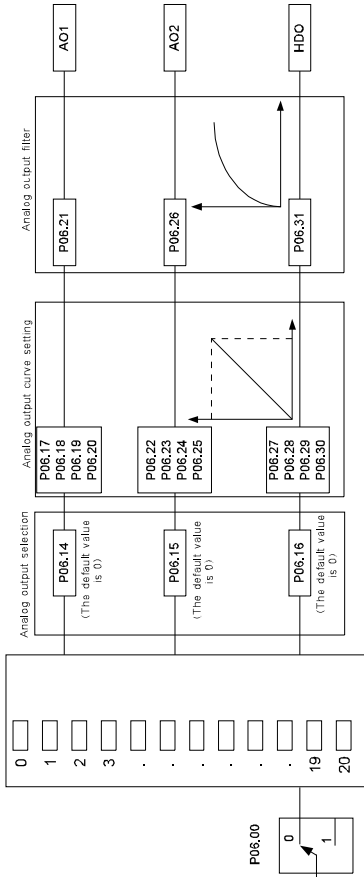

Output instructions:

Set value	Function	Instructions
0	Running frequency	0~ the Max. output frequency
1	Set frequency	0~ the Max. output frequency
2	Ramp given frequency	0~ the Max. output frequency
3	Running speed	0~2 times of the rated synchronous rotation speed of the motor
4	Output current (relative to the inverter)	0~2 times of the rated current of the inverter
5	Output current (relative to the motor)	0~2 times of the rated current of the inverter
6	Output voltage	0~1.5 times of the rated voltage of the inverter
7	Output power	0~2 times of the rated power
8	Setting torque value	0~2 times of the rated current of the motor
9	Output torque	0~2 times of the rated current of the motor
10	AI1	0~10V/0~20mA
11	AI2	0~10V/0~20mA
12	AI3	-10V~10V
13	HDI	0.00~50.00kHz
14	Setting value 1 of MODBUS communication	-1000~1000,1000 corresponds to 100.0%
15	Setting value 2 of MODBUS communication	-1000~1000,1000 corresponds to 100.0%
16	Setting value 1 of PROFIBUS/CANOPEN communication	-1000~1000,1000 corresponds to 100.0%
17	Setting value 2 of PROFIBUS/CANOPEN communication	-1000~1000,100 corresponds to 100.0%
18	Setting value 1 of Ethernet communication	-1000~1000,1000 corresponds to 100.0%
19	Setting value 2 of Ethernet communication	-1000~1000,100 corresponds to 100.0%
20~21	Reserved	
22	Torque current (100% corresponds to 10V)	0~2 times of the rated current of the motor

Set value	Function	Instructions
23	Exciting current (100% corresponds to 10V)	0~1 time of the rated current of the motor
24	Setting frequency(bipolar)	0~ the Max. output frequency
25	Ramp reference frequency (bipolar)	0~ the Max. output frequency
26	Operation speed (bipolar)	0~ the Max. output frequency
27~30	Reserved	

Relative parameters list:

Function code	Name	Detailed instruction of parameters	Default value
P06.00	HDO output	0: Open collector pole high speed pulse output 1: Open collector pole output.	0
P06.14	AO1 output	0:Running frequency	0
P06.15	AO2 output	1:Set frequency	0
P06.16	HDO high-speed pulse output	2:Ramp reference frequency 3:Running rotation speed 4:Output current (relative to the inverter) 5:Output current(relative to the motor) 6:Output voltage 7:Output power 8:Set torque value 9:Output torque 10:Analog AI1 input value 11:Analog AI2 input value 12:Analog AI3 input value 13:High speed pulse HDI input value 14:MODBUS communication set value 1 15:MODBUS communication set value 2 16:PROFIBUS/CANopen communication set value 1 17:PROFIBUS/CANopen communication set value 2	0

Function code	Name	Detailed instruction of parameters	Default value
		18: Ethernet communication set value 1 19: Ethernet communication set value 2 20~21: Reserved 22: Torque current(100% corresponds to 10V) 23: Pre-magnetizing current(100% corresponds to 10V) 24: Setting frequency(bipolar) 25: Ramp reference frequency (bipolar) 26: Operation speed (bipolar)	
P06.17	Lower output limit of AO1	-300.0%~P06.19	0.0%
P06.18	Corresponding AO1 output of lower limit	0.00V~10.00V	0.00V
P06.19	Upper output limit of AO1	P06.13~300.0%	100.0%
P06.20	The corresponding AO1 output of upper limit	0.00V~10.00V	10.00V
P06.21	AO1 output filter time	0.000s~10.000s	0.000s
P06.22	Lower output limit of AO2	-300.0%~P06.24	0.0%
P06.23	Corresponding AO2 output of lower limit	0.00V~10.00V	0.00V
P06.24	Upper output limit of AO2	P06.18~300.0%	100.0%
P06.25	The corresponding AO2 output of upper limit	0.00V~10.00V	10.00V
P06.26	AO2 output filter time	0.000s~10.000s	0.000s
P06.27	Lower output limit of HDO	-300.0%~P06.29	0.0%
P06.28	Corresponding HDO output of lower limit	0.00~50.00kHz	0.0kHz
P06.29	Upper output limit of HDO	P06.23~300.0%	100.0%
P06.30	Corresponding HDO output of upper limit	0.00~50.00kHz	50.00kHz
P06.31	HDO output filter time	0.000s~10.000s	0.000s

7.11 Digital input

Goodrive35 series inverters have 8 programmable digital input terminals and 1 open circuit

electrode output terminal in the standard configuration. All functions of the digital input terminals are programmable by the function codes. Open collector pole input can be selected into high speed pulse input terminal or common switch input terminal by function code. When selected into HDI, the user can select HDI high speed pulse input as frequency given, counting input or length pulse input by setting.

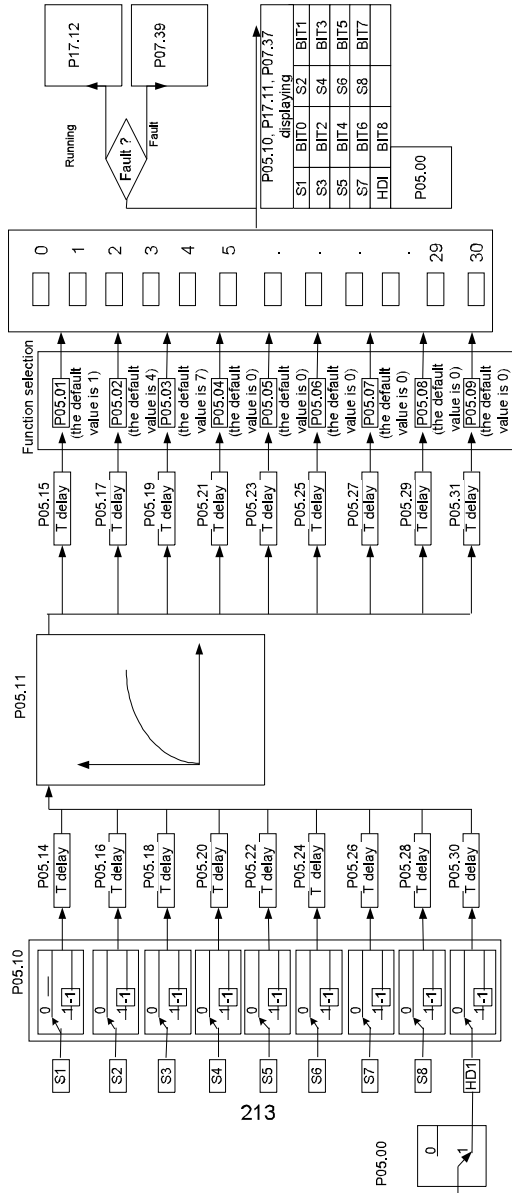

This parameter is used to set the function corresponds to the digital multi-function terminals.

Note: two different multi-function terminals can not be set as one function.

Set value	Function	Instructions
0	No function	The inverter does not work even there is input signal. It is necessary to set the terminal which can not be used to non-function to avoid misacting.
1	Forward running(FWD)	The forward or reverse rotation of the inverter can be controlled by the external terminals.
2	Reverse running(REV)	
3	3-wire running control	The terminal can determine the running mode of the inverter is 3-wire control mode. Refer to P05.13 for detailed instruction of 3-wire control mode.
4	Forward jogging	See P08.06, P08.07 and P08.08 for jogging frequency, jogging ACC/DEC time.
5	Reverse jogging	
6	Coast to stop	The inverter closes off the output. The motor is not controlled by the inverter during the stopping. This method is usually to be used when the load inertia is big and it has no requirement to the stopping time. It has the same meaning with the "coast to stop" in P01.08 and usually used in remote control.
7	Fault reset	External fault reset. It has the same function with the reset function of STOP/RST on the keypad. This function can realize remote fault reset.
8	Operation pause	The inverter decelerates to stop. But all running parameters are in the memory state. For example, PLC parameters, traverse parameters and PID parameters. After the signal disappears, the inverter will come back to the state before stopping.
9	External fault input	When the external fault signal is sent to the inverter, the inverter will report the fault and stop.
10	Frequency setting up(UP)	This parameter is used to modify the increasing and decreasing command during the external terminal given frequency.
12	Frequency setting down(DOWN)	

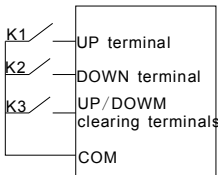
Set value	Function	Instructions								
12	Frequency increasing/decreasing setting clear	 <p>Frequency increasing/decreasing setting clear terminal can cancel the assistant channel frequency set by the internal UP/DOWN of the inverter to make the given frequency restore to the frequency given by the main given frequency channel.</p>								
13	Switch between A setting and B setting	This function can realize the shifting between the frequency setting channels.								
14	Switch between A setting and combination setting	The 13 th function can realize the shifting between A frequency given channel and B frequency given channel.								
15	Switch between B setting and combination setting	The 14 th function can realize the shifting between A frequency given channel and the combination setting channel set by P00.09 The 15 th function can realize the shifting between B frequency given channel and the combination setting channel set by P00.09								
16	Multi-step speed terminal 1	The 16 stage speeds can be set by the combination of digital state of four terminals. Note: multi-step speed 1 is the low bit; multi-step speed 4 is the high bit.								
17	Multi-step speed terminal 2									
18	Multi-step speed terminal 3									
19	Multi-step speed terminal 4	<table border="1" data-bbox="470 1189 952 1300"> <thead> <tr> <th>Multi-step speed 4</th> <th>Multi-step speed 3</th> <th>Multi-step speed 2</th> <th>Multi-step speed 1</th> </tr> </thead> <tbody> <tr> <td>BIT3</td> <td>BIT2</td> <td>BIT1</td> <td>BIT0</td> </tr> </tbody> </table>	Multi-step speed 4	Multi-step speed 3	Multi-step speed 2	Multi-step speed 1	BIT3	BIT2	BIT1	BIT0
Multi-step speed 4	Multi-step speed 3	Multi-step speed 2	Multi-step speed 1							
BIT3	BIT2	BIT1	BIT0							
20	Multi-step speed pause	Shield the multi-step speed selection terminal function to keep the setting value at the current state.								
21	ACC/DEC time selection 1	Select 4 ACC/DEC time by the combination of the 2								

Set value	Function	Instructions			
22	ACC/DEC time selection 2	terminals.			
		Terminal 1	Terminal 2	ACC/DEC time selection	Corresponding parameter
		OFF	OFF	ACC/DEC time 1	P00.11/P00.12
		ON	OFF	ACC/DEC time 2	P08.00/P08.01
		OFF	ON	ACC/DEC time 3	P08.02/P08.03
ON	ON	ACC/DEC time 4	P08.04/P08.05		
23	Simple PLC stop reset	Restart simple PLC and clear the memory state of PLC.			
24	Simple PLC pause	Program pause during PLC implement. Run at the current speed stage. After cancel the function, simple PLC continues to run.			
25	PID control pause	Temporal PID invalid and the inverter will output at the current frequency.			
26	Traverse pause (stop at the current frequency)	The inverter will stop at the current output and after canceling the function, the inverter will continue to traverse run at the current frequency.			
27	Traverse reset (return to the middle frequency)	The setting frequency of the inverter will come back to the middle frequency.			
28	Counter reset	Counter clear			
29	Torque control disabling	The inverter shifts from torque control mode to speed control mode.			
30	ACC/DEC disabling	Ensure the inverter will not be affected by the external signals (except for the stopping command) and keep the current output frequency.			
31	Counter triggering	Enable the pulse counter.			
32	Length reset	Length counter clear			
33	Frequency increasing/decreasing setting temporal clear	When the terminal closes, the frequency set by UP/DOWN can be cleared. All set frequency will be restored into the given frequency by the frequency command channel and the frequency will come back			

Set value	Function	Instructions
		to the value after the frequency increasing or decreasing.
34	DC braking	The inverter will begin DC braking after the valid command.
35	Switch between motor1 and motor2	Motor-shifting can be controlled after the terminal is valid.
36	Switch commands to keypad	After the function terminal become valid, the running command channel will be shifted into keypad running command channel and the running command channel will come back to the original state if the function terminal is invalid.
37	Switch commands to terminals	After the function terminal become valid, the running command channel will be shifted into terminal running command channel and the running command channel will come back to the original state if the function terminal is invalid.
38	Switch commands to communication	After the function terminal become valid, the running command channel will be shifted into communication running command channel and the running command channel will come back to the original state if the function terminal is invalid.
39	Pre-excitation commands	Perform pre-exciting if the terminal is valid until the terminal is invalid.
40	Power consumption clear	The power consumption will be cleared after the command is valid.
41	Power consumption retention	If the command is valid, the current running of the inverter will not affect its power consumption.
42	Keypad setting of the torque upper limit	The upper limit is set by the keypad if the command is valid.
43	Position reference input (only S8 valid)	If S8 is set to 43, the external reference can be detected.
44	Spindle direction prohibit	The function is disabled if the command is valid.

Set value	Function	Instructions
45	Spindle returning /Local position returning	The function is enabled if the command is valid.
46	Zero position selection 1	46 and 47 can select 4 returning positions and correspond to the returning position of P22.
47	Zero position selection 2	
48	Spindle scaling selection 1	7 scaling selections are available through 48, 49, and 50 and correspond to the scaling position of P22.
49	Spindle scaling selection 2	
50	Spindle scaling selection 3	
51	Switching terminal of position control and speed control	Position control and speed control can be switched.
52	Pulse input disabled	Pulse input is disabled if the command is valid.
53	Position deviation clear	Position deviation can be cleared if the command is valid.
54	Position proportional gain switch	Position proportional gain can be switched.
55	Digital position cycle positioning enabled	When command valid, the repeated positioning in the digital position mode is available.
56	E-stop	When command valid, the motor will stop within the time designated by P1.25.
57	Motor overtemperature fault input	The motor will stop when fault occurs.
58	Rigid tapping enable	The mode is enabled if the terminal is valid
59	Switch to SVPWM control	If the terminal is valid in stopping mode, it will switch to SVPWM control
60	Switch to FVC control	If the terminal is valid in stopping mode, it will switch to FVC control
61	PID pole switching	The terminal is used with P09.03 to switch the output pole
62	Undervoltage stopping input	The terminal and the enabling bit is valid, the inverter will stop at the time sst by P08.05
63	Reversed	

Relative parameters list:

Function code	Name	Detailed instruction of parameters	Default value
P05.00	HDI input selection	0: High pulse input 1: Digital input	0
P05.01	S1 terminals function selection	0: No function 1: Forward rotation operation	1
P05.02	S2 terminals function selection	2: Reverse rotation operation 3: 3-wire control operation	4
P05.03	S3 terminals function selection	4: Forward jogging 5: Reverse jogging	7
P05.04	S4 terminals function selection	6: Coast to stop 7: Fault reset	0
P05.05	S5 terminals function selection	8: Operation pause 9: External fault input	0
P05.06	S6 terminals function selection	10:Increasing frequency setting(UP) 11:Decreasing frequency setting(DOWN)	0
P05.07	S7 terminals function selection	12:Frequency setting clear	0
P05.08	S8 terminals function selection	13:Shift between A setting and B setting 14:Shift between combination setting and A setting 15:Shift between combination setting and B setting	0
P05.09	HDI terminal function selection	16:Multi-step speed terminal 1 17:Multi-step speed terminal 2 18:Multi-step speed terminal 3 19:Multi- step speed terminal 4 20:Multi- step speed pause 21:ACC/DEC time 1 22:ACC/DEC time 2 23:Simple PLC stop reset 24:Simple PLC pause 25:PID control pause 26:Traverse Pause(stop at the current frequency) 27:Traverse reset(return to the center frequency)	0

Function code	Name	Detailed instruction of parameters	Default value
		28:Counter reset 29:Torque control disabling 30:ACC/DEC disabling 31:Counter triggering 32:Length reset 33:Cancel the frequency change setting temporarily 34:DC brake 35:Shift the motor 1 into motor 2 36:Shift the command to the keypad 37:Shift the command to the terminals 38:Shift the command to the communication 39:Pre-magnetized command 40:Consumption power clear 41: Consumption power holding 42: Keypad setting of the torque upper limit 43: Position reference input (only S8 valid) 44: Spindle direction prohibit 45: Spindle returning /Local position returning 46: Zero position selection 1 47: Zero position selection 2 48: Spindle scaling selection 1 49: Spindle scaling selection 2 50: Spindle scaling selection 3 51: Switching terminal of position control and speed control 52: Pulse input disabled 53: Position deviation clear 54: Position proportional gain switch 55: Digital position cycle positioning enabled	

Function code	Name	Detailed instruction of parameters	Default value
		56: E-stop 57: Motor overtemperature fault input 58: Rigid tapping enable 59: Switch to SVPWM control 60: Switch to FVC control 61: PID pole switching 62: Undervoltage stopping input 63: Reserved	
P05.10	Polarity selection of the input terminals	0x000~0x1FF	0x000
P05.11	ON-OFF filter time	0.000~1.000s	0.010s
P05.12	Virtual terminals setting	0x000~0x1FF(0:Disabled, 1: Enabled) BIT0:S1 virtual terminal BIT1:S2 virtual terminal BIT2:S3 virtual terminal BIT3:S4 virtual terminal BIT4:S5 virtual terminal BIT5:S6 virtual terminal BIT6:S7 virtual terminal BIT7:S8 virtual terminal BIT8:HDI virtual terminal	0
P05.13	Terminals control running mode	0:2-wire control 1 1:2-wire control 2 2:3-wire control 1 3:3-wire control 2	0
P05.14	Switch-on delay of S1 terminal	0.000~50.000s	0.000s
P05.15	Switch-off delay of S1 terminal	0.000~50.000s	0.000s
P05.16	Switch-on delay of S2 terminal	0.000~50.000s	0.000s
P05.17	Switch-off delay of S2 terminal	0.000~50.000s	0.000s
P05.18	Switch-on delay of S3	0.000~50.000s	0.000s

Function code	Name	Detailed instruction of parameters	Default value
	terminal		
P05.19	Switch-off delay of S3 terminal	0.000~50.000s	0.000s
P05.20	Switch-on delay of S4 terminal	0.000~50.000s	0.000s
P05.21	Switch-off delay of S4 terminal	0.000~50.000s	0.000s
P05.22	Switch-on delay of S5 terminal	0.000~50.000s	0.000s
P05.23	Switch-off delay of S5 terminal	0.000~50.000s	0.000s
P05.24	Switch-on delay of S6 terminal	0.000~50.000s	0.000s
P05.25	Switch-off delay of S6 terminal	0.000~50.000s	0.000s
P05.26	Switch-on delay of S7 terminal	0.000~50.000s	0.000s
P05.27	Switch-off delay of S7 terminal	0.000~50.000s	0.000s
P05.28	Switch-on delay of S8 terminal	0.000~50.000s	0.000s
P05.29	Switch-off delay of S8 terminal	0.000~50.000s	0.000s
P05.30	Switch-on delay of HDI terminal	0.000~50.000s	0.000s
P05.31	Switch-off delay of HDI terminal	0.000~50.000s	0.000s
P07.37	Bus voltage at current fault		0
P17.12	Digital input terminals state	0000~01FF	0

7.12 Digital input

Goodrive35 series inverters have 2 relay output terminals and 1 Y output terminal and 1 high

speed pulse output terminal in the standard configuration. All functions of the digital input terminals are programmable by the function codes. Open collector pole input can be selected into high speed pulse input terminal or common switch input terminal by function code.

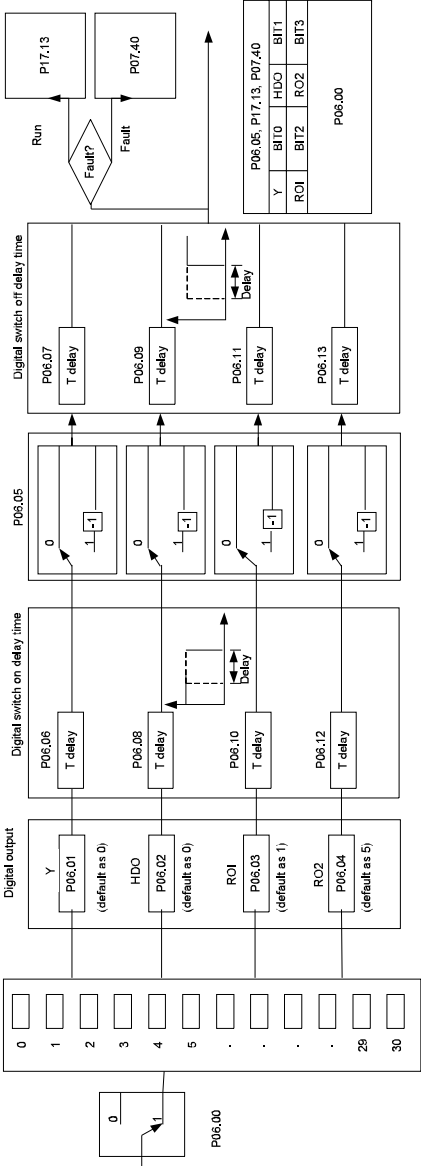

The below table is the option of the four function parameters and selecting the repeated output terminal function is allowed.

Set value	Function	Instructions
0	Invalid	The output terminal has no function.
1	Running	Output ON signal when the inverter is running and there is frequency output.
2	Forward running	Output ON signal when the inverter is running forward and there is frequency output.
3	Reverse running	Output ON signal when the inverter is running reverse and there is frequency output.
4	Jogging	Output ON signal when the inverter is jogging and there is frequency output.
5	Inverter fault	Output ON signal when the inverter is in fault
6	FDT1	Please refer to P08.32 and P08.33 for detailed information.
7	FDT2	Please refer to P08.34 and P08.35 for detailed information.
8	Frequency arrival	Please refer to P08.36 for detailed information.
9	Zero-speed running	Output ON signal when the output frequency and given frequency of the inverter is 0 at the same time.
10	Upper-limit frequency arrival	Output ON signal when the running frequency of the inverter is the upper limit frequency.
11	Upper-limit frequency arrival	Output ON signal when the running frequency of the inverter is the lower limit frequency.
12	Ready	When the main circuit and the control circuit are established and the protection function of the inverter is not active. The inverter is in the running state and it will output ON signal.
13	Pre-exciting	Output ON signal when the inverter is in the pre-exciting state.
14	Overload pre-alarm	Output ON signal if the inverter is beyond the pre-alarm point. Refer to P11.08~P11.10 for the detailed instruction.

Set value	Function	Instructions
15	Underload pre-alarm	Output ON signal if the inverter is beyond the pre-alarm point. Refer to P11.11~P11.12 for the detailed instruction.
16	Simple PLC stage completion	Output signal if the simple PLC stage is completed.
17	Simple PLC cycle completion	Output signal if the 1 simple PLC cycle is completed.
18	Set counting arrival	Output ON signal if the detected counting exceeds the set value of P08.25.
19	Fixed counting arrival	Output ON signal if the detected counting exceeds the set value of P08.26.
20	External fault valid	Output ON signal if external fault occurs.
21	Length arrival	Output ON signal if the actual detected length exceeds the set length by P08.19.
22	Running time arrival	Output ON signal if the accumulative running time of the inverter exceeds the setting time by P08.27.
23	MODBUS communication virtual terminal output	Output corresponding signal according to the setting value of MODBUS. Output ON signal if the setting value is 1 and output OFF signal if the setting value is 0.
24	PROFIBUS communication virtual terminal output	Output corresponding signal according to the setting value of PROFIBUS/CANOPEN. Output ON signal if the setting value is 1 and output OFF signal if the setting value is 0.
25	Ethernet virtual terminal output	Output the corresponding signal according to the Ethernet signal. Output ON when setting as 1 and output OFF when setting as 0.
26	Bus voltage established	Output ON according to the establishment of bus voltage
27~29	Reserved	
30	Positioning finished	Output ON when the positioning is finished
31	Spindle returning finished	Output ON when the returning is finished
32	Spindle scaling finished	Output ON when the scaling is finished

Set value	Function	Instructions
33	Speed limiting	Output ON when the speed is the upper or lower limit
34	Low bus voltage	Output ON when the value is below P8.27
35	Underload stopping output	If the enabling bit of P08.26 is valid, and it is in the underload state, ON signal will be output

Relative parameters list:

Function code	Name	Detailed instruction of parameters	Default value
P06.00	HDO output	0:Open collector pole high speed pulse output 1: Open collector pole output	0
P06.01	Y output	0:Invalid	0
P06.02	HDO output	1:In operation	0
P06.03	Relay RO1 output	2:Forward rotation operation	1
P06.04	Relay RO2 output	3:Reverse rotation operation 4: Jogging operation 5:The inverter fault 6:Frequency degree test FDT1 7:Frequency degree test FDT2 8:Frequency arrival 9:Zero speed running 10:Upper limit frequency arrival 11:Lower limit frequency arrival 12:Ready for operation 13:Pre-magnetizing 14:Overload pre-alarm 15: Underload pre-alarm 16:Completion of simple PLC stage 17:Completion of simple PLC cycle	5

Function code	Name	Detailed instruction of parameters	Default value
		18:Setting count value arrival 19:Defined count value arrival 20:External fault valid 21:Length arrival 22:Running time arrival 23:MODBUS communication virtual terminals output 24:PROFIBUS/CANopen communication virtual terminals output 25: Ethernet communication virtual terminals output 26:Bus voltage established 27~29: Reserved 30: Positioning finished 31: Spindle returning finished 32: Spindle scaling finished 33: Speed limiting 34: Low bus voltage 35: Undervoltage stopping output 36~40: Reserved	
P06.05	Polarity of output terminals	0x00~0x0F	0x00
P06.06	Y switch-on delay time	0.000~50.000s	0.000s
P06.07	Y switch-off delay time	0.000~50.000s	0.000s
P06.08	HDO switch-on delay time	0.000~50.000s (valid only when P06.00=1)	0.000s
P06.09	HDO switch-off delay time	0.000~50.000s (valid only when P06.00=1)	0.000s
P06.10	RO1 switch-on delay time	0.000~50.000s	0.000s
P06.11	RO1 switch-off delay time	0.000~50.000s	0.000s
P06.12	RO2 switch-on delay time	0.000~50.000s	0.000s
P06.13	RO2 switch-off delay time	0.000~50.000s	0.000s
P07.38	The Max. temperature at current fault		0

Function code	Name	Detailed instruction of parameters	Default value
P17.13	Digital output terminals state		0

7.13 Simple PLC

Simple PLC function is also a multi-step speed generator. The inverter can change the running frequency, direction to meet the need of processing according to the running time automatically. In the past, this function needs to be assisted by external PLC, but now the inverter can realize this function by itself.

The series inverters can control 16-stage speed with 4 groups of ACC/DEC time.

The multi-function digital output terminals or multi-function relay output an ON signal when the set PLC finishes a circle (or a stage).

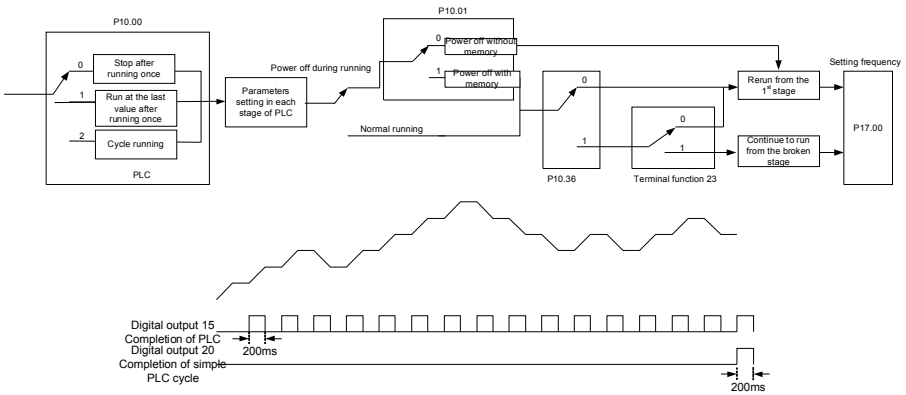

Relative parameters list:

Function code	Name	Detailed instruction of parameters	Default value
P10.00	Simple PLC	0:Stop after running once 1:Run at the final value after running once 2:Cycle running	0
P10.01	Simple PLC memory	0:Power loss without memory 1:Power loss memory	0
P10.02	Multi-step speed 0	-100.0~100.0%	0.0%
P10.03	The running time of step 0	0.0~6553.5s(min)	0.0s
P10.04	Multi-step speed 1	-100.0~100.0%	0.0%
P10.05	The running time of step 1	0.0~6553.5s(min)	0.0s
P10.06	Multi-step speed 2	-100.0~100.0%	0.0%
P10.07	The running time of step 2	0.0~6553.5s(min)	0.0s
P10.08	Multi-step speed 3	-100.0~100.0%	0.0%
P10.09	The running time of step 3	0.0~6553.5s(min)	0.0s
P10.10	Multi-step speed 4	-100.0~100.0%	0.0%
P10.11	The running time of step 4	0.0~6553.5s(min)	0.0s
P10.12	Multi-step speed 5	-100.0~100.0%	0.0%
P10.13	The running time of step 5	0.0~6553.5s(min)	0.0s
P10.14	Multi-step speed 6	-100.0~100.0%	0.0%
P10.15	The running time of step 6	0.0~6553.5s(min)	0.0s
P10.16	Multi-step speed 7	-100.0~100.0%	0.0%
P10.17	The running time of step 7	0.0~6553.5s(min)	0.0s
P10.18	Multi-step speed 8	-100.0~100.0%	0.0%
P10.19	The running time of step 8	0.0~6553.5s(min)	0.0s
P10.20	Multi-step speed 9	-100.0~100.0%	0.0%
P10.21	The running time of step 9	0.0~6553.5s(min)	0.0s
P10.22	Multi-step speed 10	-100.0~100.0%	0.0%
P10.23	The running time of step 10	0.0~6553.5s(min)	0.0s
P10.24	Multi-step speed 11	-100.0~100.0%	0.0%
P10.25	The running time of step 11	0.0~6553.5s(min)	0.0s
P10.26	Multi-step speed 12	-100.0~100.0%	0.0%
P10.27	The running time of step 12	0.0~6553.5s(min)	0.0s

Function code	Name	Detailed instruction of parameters	Default value
P10.28	Multi-step speed 13	-100.0~100.0%	0.0%
P10.29	The running time of step 13	0.0~6553.5s(min)	0.0s
P10.30	Multi-step speed 14	-100.0~100.0%	0.0%
P10.31	The running time of step 14	0.0~6553.5s(min)	0.0s
P10.32	Multi-step speed 15	-100.0~100.0%	0.0%
P10.33	The running time of step 15	0.0~6553.5s(min)	0.0s
P10.36	PLC restart	0:Restart from the first stage 1:Continue to run from the stop frequency	0
P10.34	Simple PLC 0~7 step ACC/DEC time	0x0000~0xFFFF	0000
P10.35	Simple PLC 8~15 step ACC/DEC time	0x0000~0xFFFF	0000
P05.01~P05.09	Digital input function selection	23:Simple PLC stop reset 24:Simple PLC pause 25:PID control pause	
P06.01~P06.04	Digital output function selection	15: Underload pre-alarm 16:Completion of simple PLC stage	
P17.00	Set frequency	0.00Hz~P00.03 (the Max. output frequency)	0.00Hz
P17.27	Simple PLC and the current stage of the multi-step speed	0~15	0

7.14 Multi-step speed running

Set the parameters when the inverter carries out multi-step speed running. Goodrive35 series inverters can set 16-stage speed which can be selected by the combination code of multi-step speed terminals 1~4. They correspond to multi-step speed 0 to 15.

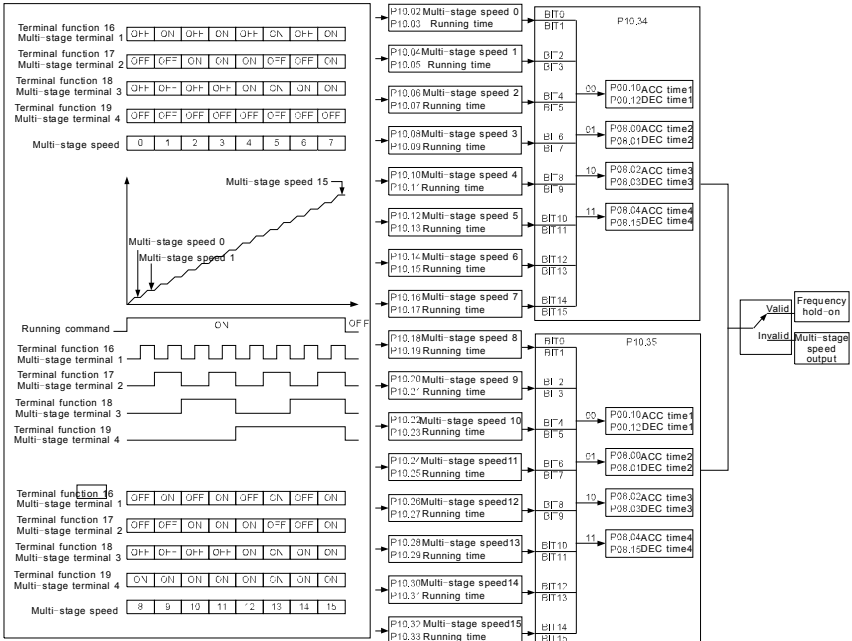

Relative parameters list:

Function code	Name	Detailed instruction of parameters	Default value
P10.02	Multi-step speed 0	-100.0~100.0%	0.0%
P10.03	The running time of step 0	0.0~6553.5s(min)	0.0s
P10.04	Multi-step speed 1	-100.0~100.0%	0.0%
P10.05	The running time of step 1	0.0~6553.5s(min)	0.0s
P10.06	Multi-step speed 2	-100.0~100.0%	0.0%
P10.07	The running time of step 2	0.0~6553.5s(min)	0.0s
P10.08	Multi-step speed 3	-100.0~100.0%	0.0%
P10.09	The running time of step 3	0.0~6553.5s(min)	0.0s
P10.10	Multi-step speed 4	-100.0~100.0%	0.0%
P10.11	The running time of step 4	0.0~6553.5s(min)	0.0s
P10.12	Multi-step speed 5	-100.0~100.0%	0.0%
P10.13	The running time of step 5	0.0~6553.5s(min)	0.0s
P10.14	Multi-step speed 6	-100.0~100.0%	0.0%
P10.15	The running time of step 6	0.0~6553.5s(min)	0.0s

Function code	Name	Detailed instruction of parameters	Default value
P10.16	Multi-step speed 7	-100.0~100.0%	0.0%
P10.17	The running time of step 7	0.0~6553.5s(min)	0.0s
P10.18	Multi-step speed 8	-100.0~100.0%	0.0%
P10.19	The running time of step 8	0.0~6553.5s(min)	0.0s
P10.20	Multi-step speed 9	-100.0~100.0%	0.0%
P10.21	The running time of step 9	0.0~6553.5s(min)	0.0s
P10.22	Multi-step speed 10	-100.0~100.0%	0.0%
P10.23	The running time of step 10	0.0~6553.5s(min)	0.0s
P10.24	Multi-step speed 11	-100.0~100.0%	0.0%
P10.25	The running time of step 11	0.0~6553.5s(min)	0.0s
P10.26	Multi-step speed 12	-100.0~100.0%	0.0%
P10.27	The running time of step 12	0.0~6553.5s(min)	0.0s
P10.28	Multi-step speed 13	-100.0~100.0%	0.0%
P10.29	The running time of step 13	0.0~6553.5s(min)	0.0s
P10.30	Multi-step speed 14	-100.0~100.0%	0.0%
P10.31	The running time of step 14	0.0~6553.5s(min)	0.0s
P10.32	Multi-step speed 15	-100.0~100.0%	0.0%
P10.33	The running time of step 15	0.0~6553.5s(min)	0.0s
P10.34	Simple PLC 0~7 step ACC/DEC time	0x0000~0XFFFF	0000
P10.35	Simple PLC 8~15 step ACC/DEC time	0x0000~0XFFFF	0000
P05.01~ P05.09	Digital input function selection	16:Multi-step speed terminal 1 17:Multi-step speed terminal 2 18:Multi-step speed terminal 3 19:Multi-step speed terminal 4 20:Multi-step speed pause	
P17.27	Simple PLC and the current step of the multi-step speed	0~15	0

7.15 PID control

PID control is commonly used to control the procedure through the controlled procedure. Adjust the

output frequency by proportional, integral, differential operation with the dispersion of the target signals to stabilize the value on the target. It is possible to apply to the flow, pressure and temperature control. Figure of basic control is as below:

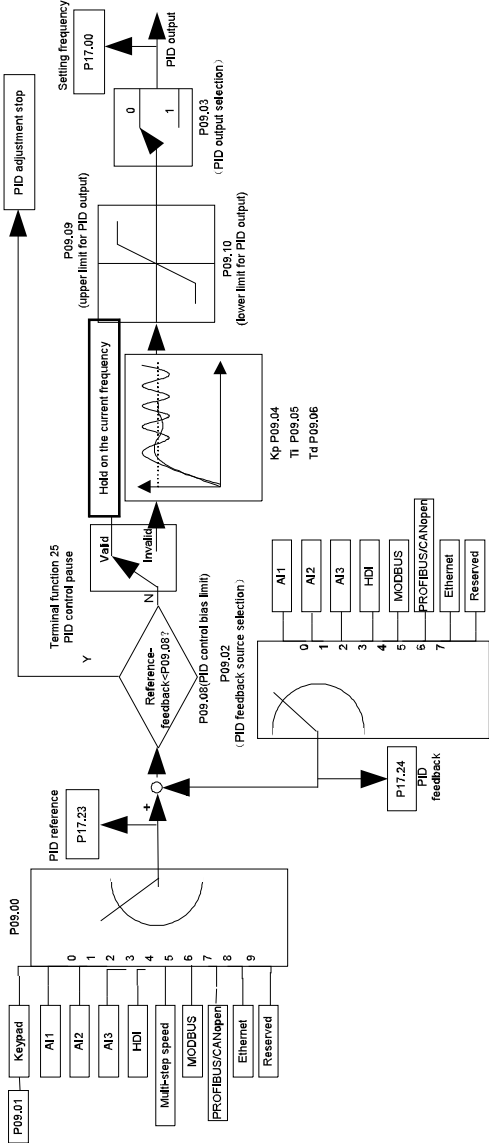

Simple illustration of the PID control operation and adjustment:

Proportional adjustment (Kp): when there is an error between the feedback and the reference, a proportional adjustment will be output. If the error is constant, the adjustment will be constant, too. Proportional adjustment can respond to the feedback change quickly, but it can not realize non-fault control. The gain will increase with the adjustment speed, but too much gain may cause vibration. The adjustment method is: set a long integral time and derivative time to 0 first. Secondly make the system run by proportional adjustment and change the reference. And then watch the error of the feedback signal and the reference. If the static error is available (for example, increasing the reference, the feedback will be less than the reference after a stable system), continue to increase the gain, vice versa. Repeat the action until the static error achieves a little value.

Integral time (Ti): the output adjustment will accumulate if there is an error between the feedback and the reference. The adjustment will keep on increasing until the error disappears. If the error is existent all the time, the integration adjustor can cancel the static error effectively. Vibration may occur as a result of unstable system caused by repeated over-adjustment if the integration adjustor is too strong. The features of this kind of vibration are: the fluctuating feedback signal (around the reference) and increasing traverse range will cause vibration. Adjust the integral time parameter from a big value to a little one to change the integral time and monitor the result until a stable system speed is available.

Derivative time (Td): when the error between the feedback and the reference, a proportional adjustment will be output. The adjustment only depends on the direction and value of the error change other than the error itself. The derivation adjustment controls the change of feedback signals according to the changing trend when it fluctuates. Because the derivation may enlarge the interference to the system, especially the frequent-changing interference, please use it carefully.

When P00.06, P00.07=7 or P04.27=6, the running mode of the inverter is procedure PID control.

7.15.1 General steps of PID parameters setting:

a Ensure the gain P

When ensure the gain P, firstly cancel the PID integration and derivation (set $T_i=0$ and $T_d=0$, see the PID parameter setting for detailed information) to make proportional adjustment is the only method to PID. Set the input as 60%~70% of the permitted Max. Value and increase gain P from 0 until the system vibration occurs, vice versa, and record the PID value and set it to 60%~70% of the current value. Then the gain P commission is finished.

b Ensure the integral time Ti

After ensuring the gain P, set an original value of a bigger integral time and decrease it until the system vibration occurs, vice versa, until the system vibration disappear. Record the T_i and set the integral time to 150%~180% of the current value. Then integral time commission is finished.

c Ensure the derivative time T_d

Generally, it is not necessary to set T_d which is 0.

If it needs to be set, set it to 30% of the value without vibration via the same method with P and T_i .

d Commission the system with and without load and then adjust the PID parameter until it is available.

7.15.2 PID inching

After setting the PID control parameters, inching is possible by following means:

Control the overshoot

Shorten the derivative time and prolong the integral time when overshoot occurs.

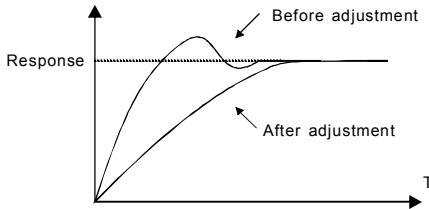

Achieve the stable state as soon as possible

Shorten the integral time (T_i) and prolong the derivative time (T_d) even the overshoot occurs, but the control should be stable as soon as possible.

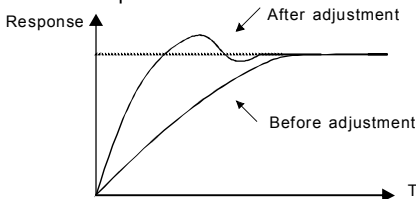

Control long vibration

If the vibration periods are longer than the set value of integral time (T_i), it is necessary to prolong the integral time (T_i) to control the vibration for the strong integration.

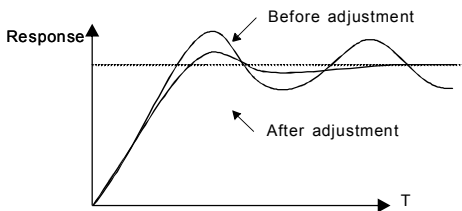

Control short vibration

Short vibration period and the same set value with the derivative time (T_d) mean that the derivative time is strong. Shortening the derivative time (T_d) can control the vibration. When setting the derivative time as 0.00 (no derivative control) is useless to control the vibration, decrease the gain.

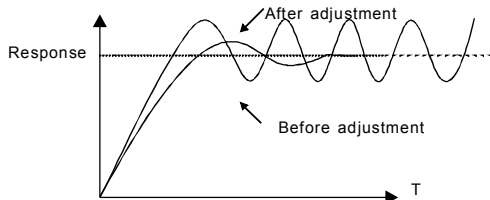

Relative parameters list:

Function code	Name	Detailed instruction of parameters	Default value
P09.00	PID reference source	0: Keypad (P09.01) 1: AI1 2: AI2 3: AI3 4: HDI 5: Multi-step speed set 6: MODBUS communication set 7: PROFIBUS/CANopen communication set 8: Ethernet communication set 9: Reserved	0
P09.01	Keypad PID preset	-100.0%~100.0%	0.0%
P09.02	PID feedback source	0: AI1 1: AI2 2: AI3	0

Function code	Name	Detailed instruction of parameters	Default value
		3: HDI 4:MODBUS communication feedback 5:PROFIBUS/CANopen communication feedback 6:Ethernet communication feedback 7:Reserve	
P09.03	PID output feature	0:PID output is positive 1:PID output is negative	0
P09.04	Proportional gain (Kp)	0.00~100.00	1.00
P09.05	Integral time(Ti)	0.00~50.00s	100s
P09.06	Differential time(Td)	0.00~10.00s	0.00s
P09.07	Sampling cycle(T)	0.001~1.000s	0.001s
P09.08	PID control deviation limit	0.0~100.0%	0.0%
P09.09	Output upper limit of PID	P09.10~100.0% (Max. frequency or the Max. voltage)	100.0%
P09.10	Output lower limit of PID	-100.0%~P09.09 (Max. frequency or the Max. voltage)	0.0%
P09.11	Detection value of feedback offline	0.0~100.0%	0.0%
P09.12	Detection time of feedback offline	0.0~3600.0s	1.0s
P09.13	PID adjustment	0x000~0x111 LED ones: 0:Keep the integral adjustment ON while the frequency achieves upper or lower limit. 1:Stop the integral adjustment while the frequency achieves the upper or lower limit LED tens: 0:The same with the setting direction 1:Opposite to the setting direction LED hundreds: when P00.08 is 0	0x001

Function code	Name	Detailed instruction of parameters	Default value
		0: Limit to the maximum frequency 1: Limit to A frequency	
P17.00	Set frequency	0.00Hz~P00.03 (the Max. frequency)	0.00Hz
P17.23	PID reference	-100.0~100.0%	0.0%
P17.24	PID feedback	-100.0~100.0%	0.0%

7.16 Commissioning for special functions

7.16.1 Wiring mode of the encoder and pulse reference terminal

1. Differential output (suitable to C1, H1 and H2)

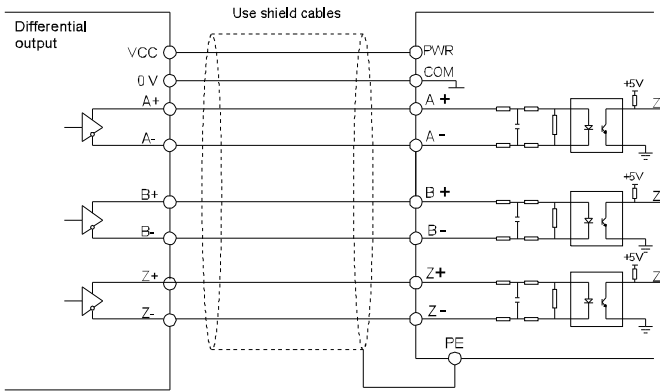

Note: The diagram of differential output is given to the H1 interface, C1 interface applies opto-isolator and H2 interface applies differential chips. The external wiring is the same as that of H1.

2. Open collector output (suitable to C1 and H1)

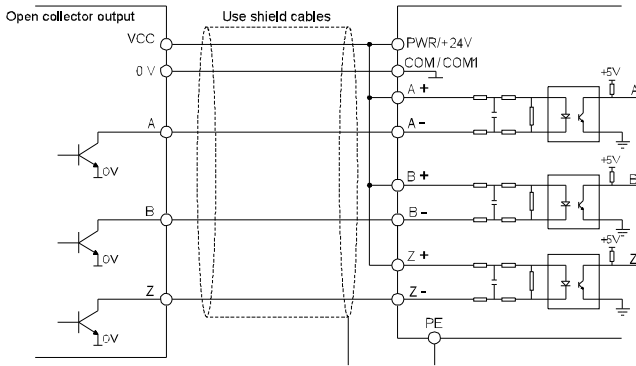

3. Complementary output (suitable to C1 and H1)

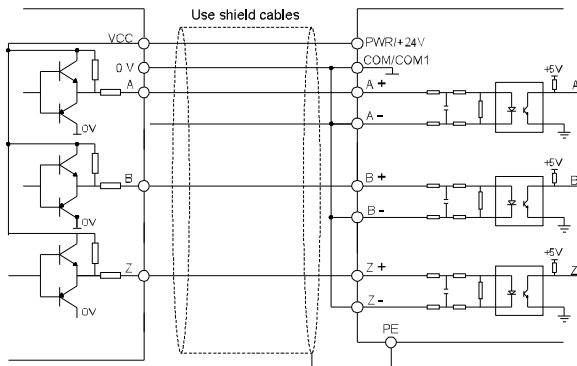

Note:

1. Above diagrams are given to the features of common encoder and suitable to the H1 interface.
2. The diagram of differential output is given to the H1 interface, C1 interface applies opto-isolator and H2 interface applies differential chips. The external wiring is the same as that of H1.
3. If the external current is limited, C1 and H1 interface is suitable to encoder signal and pulse reference signal input with greater voltage.

7.16.2 Commissioning steps

1. Close loop vector debugging of AM

- (1) Set P00.18=1 and restore to the factory settings.
- (2) Set the parameters of P00.03, P00.04 and P02 group
- (3) Motor autotuning

- a) Set P00.15=1 and begin rotating autotuning
- b) Set P00.15=2 and begin static autotuning

De-couple the load from the motor to carry out rotating autotuning; otherwise, carry out static autotuning. The parameters after autotuning can be saved in P02 group automatically.

- (4) Check the encoder is installed and correctly set

- a) Ensure the encoder direction and parameters setting

Set P20.01 and set P00.00=2, P00.10=20Hz. Start the inverter and watch the value of P18.00. If the value is negative, the direction of the encoder is reversed and it is necessary to set P20.02=1, if a huge bias exists, then the set value of P20.01 is wrong. Check if the fluctuation of P18.02 exists, then the set value of P20.01 is wrong and check the wiring and the shield layer.

- b) Ensure the direction of Z pulse

Set P00.10=20Hz and P00.13 and observe the value of P18.02 to ensure the value is less than 5. If the reverse function of Z pulse are not available after setting P20.02, then exchange A and B phase of the encoder after power off. And then observe the rotating value of P18.02 to ensure how far the forward value deviate from the reverse value. The direction of Z pulse only impacts the positioning accuracy of forward/reverse rotating if Z pulse is applied in the spindle positioning.

- (5) Trial running of the close loop vector

Set P00.00=3, carry out close loop vector control and adjust P00.10 and the speed loop and current loop PI parameters.

- (6) The weak magnetism control

Set P03.26=0~2000 and observe the weak magnetism control. Adjust P03.22~P03.24 according the actual need.

2. Close loop vector debugging of SM

- (1) Set P00.18=1 and restore to the factory settings.
- (2) Set P00.03=3, P00.03, P00.04 and the parameters in P02 group.
- (3) Set P20.00 and P20.01.

If rotary transformer encoder is selected, please set the pulse pair of the encoder (the number of pole pair*1024), if the pole pair is 4, please set P20.01=4096.

- (4) Check the encoder is installed and correctly set.

Observe the value of P18.21 after motor stopping to ensure the value has no fluctuations or small

fluctuations. But check the wiring and grounding if the fluctuation is huge. Rotate the motor slowly and the value of P18.21 may change slowly, too. If the value of P18.02 does not change and not equal to 0 after several cycles, then the signal of encoder Z is correct.

(5) Autotuning of the pole initial angle

Set P20.11=1 or 2 (1 is the rotating autotuning and 2 is the static autotuning) and press "RUN".

a) Rotating autotuning (P20.11=1)

Detect the pole position in the beginning, and then accelerate to 10Hz to autotune the pole position of Z pulse, after that decelerate to stop.

If ENC1O or ENC1D occurs during the operation, please set P20.02=1 and then reautotune. If ENC1Z occurs, check the connection of Z pulse.

The result will be saved in P20.09 and P20.10 after autotuning.

b) Static autotuning

It is recommended to apply rotating autotuning P20.11=1 to get higher autotuning precision if the load can be de-coupled. The other autotuning mode is also available if the load can not de-couple.

The pole position after autotuning is saved in P20.09 and P20.10.

(6) Trial running of the close loop vector

Adjust P0.10 and the speed loop and current loop PI parameters in P3 group. If fluctuation occurs, reduce the value of P03.00 and P03.03 and P03.09 and P03.10. If the current fluctuates at low speed, adjust P20.05.

Note: reset P20.02 after change the motor or encoder wiring and reautotune the angle of Z pulse.

3. Debugging steps of pulse string control

Pulse input is based on close loop vector control and speed detection is applied in the subsequent steps.

(1) Set P00.18=1 and restore to the factory settings.

(2) Set P00.03 and P00.04 and the parameters in P02 group.

(3) Motor autotuning: rotating autotuning and static autotuning.

(4) Check the encoder is installed and correctly set.

Set P00.00=3 and P00.10=20Hz and operate. Check the control and performance of the system.

(5) Set P21.00=1 and select the position control as the position mode. There are 4 pulse command modes which can be selected by P21.01.

In the position mode, the user can select the high/low bit of the reference and feedback value, P18.02, P18.00, P18.17, P18.19 and the relationship between P18.08 and P18.02, P18.17, P18.18 and P18.19.

(6) P21.02 and P21.03 can be shifted through speed command, torque command and terminal operation.

(7) If set P21.08 to 0, the position control is invalid, the pulse train is the frequency source and P21.13 is 100%. The deceleration and acceleration time are determined by the deceleration and acceleration time of the pulse train, but the deceleration and acceleration time of the pulse train in the system can be adjusted. If the pulse train is selected to control the speed, set P21.00=0, P00.06 or P00.07=12, AB pulse train, then the acceleration and deceleration time depend on the time of the inverter and the parameter setting is determined by P21. In speed control mode, set the filter time of AB pulse by P21.29.

(8) The input frequency of the pulse train is the same as the feedback frequency of the encoder pulse. The relationship between them can be changed by modifying P21.11 and P21.12.

4. Debugging steps of spindle positioning

The spindle positioning is the function of stopping such as zeroing and scaling on the basis of close loop vector control.

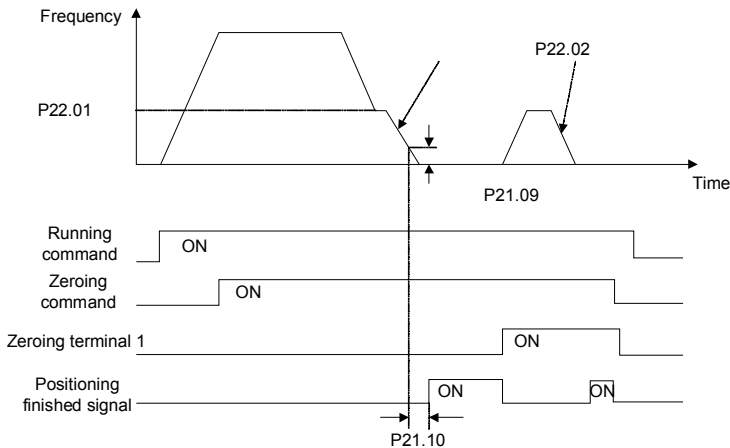

The steps of (1) ~ (4) are the same as the 4 steps in close-loop vector control mode. The function of spindle positioning is available in the position control mode and speed control mode.

(5) Set P22.00.bit0=1 and P22.00.bit1. If the system applies encoder to detect the speed, set P22.00.bit1=0, and if the system applies the photoelectric switch to detect the speed, set P22.00.bit1=1; set P22.00.bit2, P22.00.bit3 and P22.00.bit7

(6) Spindle zeroing

a Set P22.00.bit4 to select the positioning direction.

b There are 4 zero positions in P22 group. Set P05 to select the zeroing position. Operation on

P18.10 can watch the stopping state.

C The positioning length is determined by the deceleration time and the deceleration speed.

(7) Spindle scaling

There are 7 scale positions in P22 group. Set P05 to select the scale position. Enable corresponding terminal after motor stopping, the motor will inquiry the scaling state and turn to corresponding position. Operation on P18.09 can watch the state.

(8) Priority of the speed control, position control, zeroing and scaling

The priority of speed control > The priority of scaling

If the system runs at the scaling mode, when the spindle positioning is disabled, the motor will runs at the speed mode or position mode.

The priority of zeroing > The priority of scaling

The scaling commands are valid if the scaling terminal is turning from 000state to non-000state. If 000~011, then the spindle will operate scaling 3, the transition time of terminal switching is less than 10ms, otherwise wrong scaling command may be carried out.

(9) Positioning

In positioning, the gain of position loop is P21.03, but when the positioning is finished, it is P21.02.

Adjust P03.00, P03.01, P20.05 and P21.02 to keep the position and stabilize the system.

(10) Positioning command (bit6 of P22.00)

Signal of electrical level: Positioning command can only be executed after operation command.

Signal of pulse: Operation command is not needed for positioning command. And it will switch to speed operation mode if operation command is available.

(11) Spindle reference selection (bit0 of P22.00)

Below positioning modes are available in encoder Z pulse positioning:

a. The encoder is installed on the motor shaft and the shaft is rigid-connected to the spindle with the ratio of 1:1.

b. The encoder is installed on the motor shaft and the shaft is connected to the spindle by belt with the ratio of 1:1.

It is recommended to begin positioning at the area close to the switch because the belt may slide when the spindle rotates at a high speed to cause inaccurate positioning.

c. The encoder is installed on the spindle and the motor shaft is connected to the spindle by belt. The drive ratio can not be 1:1.

It is necessary to set P20.06 and set P22.14 to be 1. The control performance of close loop vector may be affected if the encoder is not installed on the motor.

Below spindle positioning mode is available:

a. The encoder is installed on the motor shaft. The drive ratio can not be 1:1.

It is necessary to set P22.14 at the same time.

5. Digital positioning

The figure is shown as below:

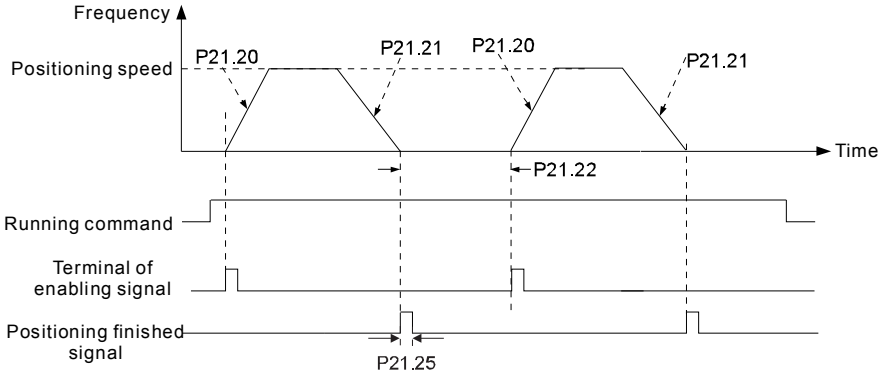

The steps of (1) ~ (4) are the same as the 4 steps in close-loop vector control mode. After the 4 steps, the control requirements can be met.

(5) Set P21.00=0x11 and set P21.17, P21.11, P21.12, P21.18, P21.19, P21.20 and P21.21 according to actual needs.

(6) Single positioning operation

Set P21.16.bit1=0, and the motor will set as step (5) and keep on the positioning place.

(7) Loop positioning operation

Set P21.16.bit1=1 to enable the loop positioning which includes continuous mode and repeated mode. The operation is also available by terminals function.

6. Photoelectric switch positioning

Photoelectric switch positioning is to position in the close loop vector control mode.

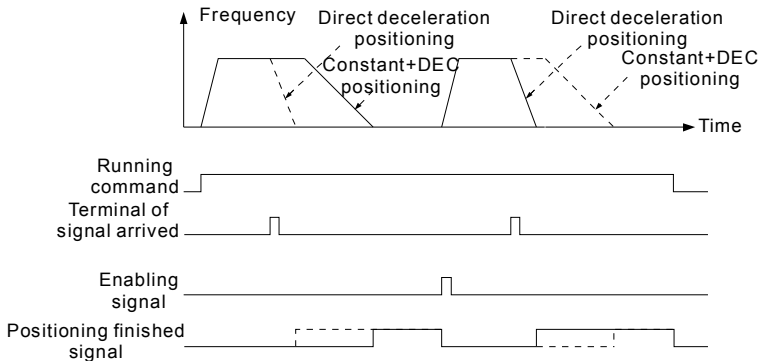

The steps of (1) ~ (4) are the same as the 4 steps in close-loop vector control mode. After the 4 steps, the control requirements can be met.

(5) Set P21.00=0x21 to enable the positioning. The signal is only connected with S8. Set P05.08=43 and P21.17, P21.11, P21.12 and P21.21. If the operation speed is big or the setting placement is too small, the positioning deceleration time is invalid and it will enter into the direct deceleration mode.

(6) Positioning operation

The motor will keep on the current position after positioning. Set group P05. If the terminal receives the enabling signal, the motor will operate at the setting speed in speed mode, after receiving photoelectric switch signal, it will position again.

(7) Position retention

During the positioning, the position loop gain is P21.03, but after positioning, it is P21.02. Adjust P03.00, P03.01, P20.05 and P21.02 to keep the position and avoid vibration.

7.17 Fault solutions

Goodrive35 series inverters provide sufficient fault procedure information for the convenience of user's application.

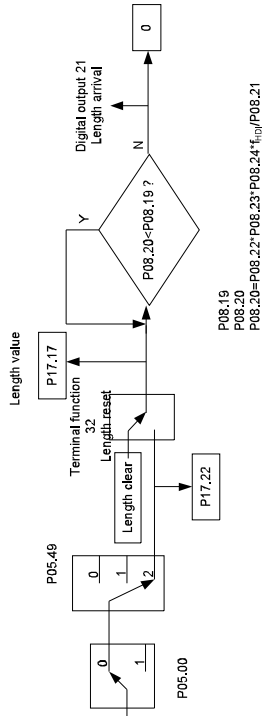

Relative parameters list:

Function code	Name	Detailed instruction of parameters	Default value
P07.27	Current fault type	0:No fault	0
P07.28	Previous fault type	1:IIGBT U phase protection(OUT1)	
P07.29	Previous 2 fault type	2:IIGBT V phase protection(OUT2)	
P07.30	Previous 3 fault type	3:IIGBT W phase protection(OUT3)	
P07.31	Previous 4 fault type	4:OC1	
P07.32	Previous 5 fault type	5:OC2	
		6:OC3	
		7:OV1	
		8:OV2	
		9:OV3	
		10:UV	
		11:Motor overload(OL1)	

Function code	Name	Detailed instruction of parameters	Default value
		12:The inverter overload(OL2) 13:Input side phase loss(SPI) 14:Output side phase loss(SPO) 15:Overheat of the rectifier module(OH1) 16:Overheat fault of the inverter module(OH2) 17:External fault(EF) 18:485 communication fault(CE) 19:Current detection fault(ItE) 20:Motor antotune fault(tE) 21:EEPROM operation fault(EEP) 22:PID response offline fault(PIDE) 23:Braking unit fault(bCE) 24:Running time arrival(END) 25:Electrical overload(OL3) 26:Panel communication fault(PCE) 27:Parameter uploading fault (UPE) 28:Parameter downloading fault(DNE) 29:PROFIBUS/CANOPEN communication fault(E-DP) 30:Ethernet communication fault(E-NET) 31: CANopen communication fault(E-CAN) 32:Grounding short circuit fault 1(ETH1) 33:Grounding short circuit fault 2(ETH2) 34:Speed deviation fault(dEu) 35:Maladjustment(STu) 36: Undervoltage fault(LL)	
P07.33	Running frequency at current fault		0.00Hz
P07.34	Ramp reference frequency at current fault		0.00Hz

Function code	Name	Detailed instruction of parameters	Default value
P07.35	Output voltage at the current fault		0V
P07.36	Output current at current fault		0.0A
P07.37	Bus voltage at current fault		0.0V
P07.38	The Max. temperature at current fault		0.0℃
P07.39	Input terminals state at current fault		0
P07.40	Output terminals state at current fault		0
P07.41	Running frequency at previous fault		0.00Hz
P07.42	Ramp reference frequency at previous fault		0.00Hz
P07.43	Output voltage at previous fault		0V
P07.44	The output current at previous fault		0.0A
P07.45	Bus voltage at previous fault		0.0V
P07.46	The Max. temperature at previous fault		0.0℃
P07.47	Input terminals state at previous fault		0
P07.48	Output terminals state at previous fault		0
P07.49	Running frequency at previous 2 fault		0.00Hz
P07.50	Output voltage at previous 2 faults		0.00Hz
P07.51	Output current at previous 2 faults		0V

Function code	Name	Detailed instruction of parameters	Default value
P07.52	Output current at previous 2 fault		0.0A
P07.53	Bus voltage at previous 2 fault		0.0V
P07.54	The Max. temperature at previous 2 fault		0.0°C
P07.55	Input terminals state at previous 2 fault		0
P07.56	Output terminals state at previous 2 fault		0

Fault tracking

8

8.1 What this chapter contains

This chapter tells how to reset faults and view fault history. It also lists all alarm and fault messages including the possible cause and corrective actions.



⚡ Only qualified electricians are allowed to maintain the inverter. Read the safety instructions in chapter Safety precautions before working on the inverter.

8.2 Alarm and fault indications

Fault is indicated by LEDs. See *Operation Procedure*. When **TRIP** light is on, an alarm or fault message on the panel display indicates abnormal inverter state. Using the information given in this chapter, most alarm and fault cause can be identified and corrected. If not, contact with the INVT office.

8.3 How to reset

The inverter can be reset by pressing the keypad key **STOP/RST**, through digital input, or by switching the power light. When the fault has been removed, the motor can be restarted.

8.4 Fault history

Function codes P07.25~P07.30 store 6 recent faults. Function codes P07.31~P07.38, P07.39~P7.46, P07.47~P07.54 show drive operation data at the time the latest 3 faults occurred.

8.5 Fault instruction and solution

Do as the following after the inverter fault:

1. Check to ensure there is nothing wrong with the keypad. If not, please contact with the local INVT office.
2. If there is nothing wrong, please check P07 and ensure the corresponding recorded fault parameters to confirm the real state when the current fault occurs by all parameters.
3. See the following table for detailed solution and check the corresponding abnormal state.
4. Eliminate the fault and ask for relative help.
5. Check to eliminate the fault and carry out fault reset to run the inverter.

Code	Fault	Cause	Solution
OUt1	IGBT U phase protection	<ul style="list-style-type: none"> ●The acceleration is too fast 	<ul style="list-style-type: none"> ● Increase Acc time ● Change the power unit ● Check the driving wires ● Check if there is strong interference to the external equipment
OUt2	IGBT V phase protection	<ul style="list-style-type: none"> ●There is damage to the internal to IGBT of the phase 	
OUt3	IGBT W phase protection	<ul style="list-style-type: none"> ●The connection of the driving wires is not good ●The grounding is not good 	
OC1	Accelerating overcurrent	<ul style="list-style-type: none"> ●The acceleration or deceleration is too fast 	<ul style="list-style-type: none"> ●Increase the ACC time ●Check the input power ●Select the inverter with a larger power ●Check if the load is short circuited (the grounding short circuited or the wire short circuited) or the rotation is not smooth ●Check the output configuration. ●Check if there is strong interference
OC2	Decelerating overcurrent	<ul style="list-style-type: none"> ●The voltage of the grid is too low 	
OC3	Constant overcurrent	<ul style="list-style-type: none"> ●The power of the inverter is too low ●The load transients or is abnormal ●The grounding is short circuited or the output is phase loss ●There is strong external interference 	
OV1	Accelerating overvoltage	<ul style="list-style-type: none"> ●The input voltage is abnormal ●There is large energy feedback 	<ul style="list-style-type: none"> ●Check the input power ●Check if the DEC time of the load is too short or the inverter starts during the rotation of the motor or it needs to increase the energy consumption components
OV2	Decelerating overvoltage		
OV3	Constant overvoltage		
UV	Bus undervoltage fault	<ul style="list-style-type: none"> ●The voltage of the power supply is too low 	<ul style="list-style-type: none"> ●Check the input power of the supply line

Code	Fault	Cause	Solution
OL1	Motor overload	<ul style="list-style-type: none"> ●The voltage of the power supply is too low ●The motor setting rated current is incorrect ●The motor stall or load transients is too strong 	<ul style="list-style-type: none"> ●Check the power of the supply line ●Reset the rated current of the motor ●Check the load and adjust the torque lift
OL2	Inverter overload	<ul style="list-style-type: none"> ●The acceleration is too fast ●Reset the rotating motor ●The voltage of the power supply is too low. ●The load is too heavy. ●Close loop vector control, reverse direction of the code panel and long low-speed operation 	<ul style="list-style-type: none"> ●Increase the ACC time ●Avoid the restarting after stopping. ●Check the power of the supply line ●Select an inverter with bigger power. ●Select a proper motor.
OL3	Electrical overload	<ul style="list-style-type: none"> ●The inverter will report overload pre-alarm according to the set value. 	<ul style="list-style-type: none"> ●Check the load and the overload pre-alarm point.
SPI	Input phase loss	<ul style="list-style-type: none"> ●Phase loss or fluctuation of input R,S,T 	<ul style="list-style-type: none"> ●Check input power ●Check installation distribution
SPO	Output phase loss	<ul style="list-style-type: none"> ●U,V,W phase loss input(or serious asymmetrical three phase of the load) 	<ul style="list-style-type: none"> ●Check the output distribution ●Check the motor and cable
OH1	Rectifying module overheated	<ul style="list-style-type: none"> ●Air duct jam or fan damage ●Ambient temperature is too high. ●The time of overload running is too long. 	<ul style="list-style-type: none"> ●Refer to the overcurrent solution ●Redistribute dredge the wind channel or change the fan ●Low the ambient temperature ●Check and reconnect ●Change the power ●Change the power unit ●Change the main control panel
OH2	IGBT overheated		
EF	External fault	<ul style="list-style-type: none"> ●SI external fault input terminals action 	<ul style="list-style-type: none"> ●Check the external device input

Code	Fault	Cause	Solution
CE	485 communication fault	<ul style="list-style-type: none"> ●The baud rate setting is incorrect. ●Fault occurs to the communication wiring. ●The communication address is wrong. ●There is strong interference to the communication. 	<ul style="list-style-type: none"> ●Set proper baud rate ●Check the communication connection distribution ●Set proper communication address. ●Change or replace the connection distribution or improve the anti-interference capability. ●
ItE	Current-detecting fault	<ul style="list-style-type: none"> ●The connection of the control board is not good ●Assistant power is bad ●Hoare components is broken ●The modifying circuit is abnormal. 	<ul style="list-style-type: none"> ●Check the connector and repatch ●Change the Hoare Change the main control panel
tE	Motor-autotuning fault	<ul style="list-style-type: none"> ●The motor capacity does not comply with the inverter capability ●The rated parameter of the motor does not set correctly. ●The offset between the parameters from autotune and the standard parameter is huge ●Autotune overtime 	<ul style="list-style-type: none"> ●Change the inverter mode ●Set the ratedparameter according to the motor name plate ●Empty the motor load and reidentify ●Check the motor connection and set the parameter. ●Check if the upper limit frequency is above 2/3 of the rated frequency.
EEP	EEPROM operation fault	<ul style="list-style-type: none"> ●Error of controlling the write and read of the parameters ●Damage to EEPROM 	<ul style="list-style-type: none"> ●Press STOP/RST to reset ●Change the main control panel
PIDE	PID feedback outline fault	<ul style="list-style-type: none"> ●PID feedback offline ●PID feedback source disappear 	<ul style="list-style-type: none"> ●Check the PID feedback signal ●Check the PID feedback source

Code	Fault	Cause	Solution
bCE	Braking unit fault	<ul style="list-style-type: none"> ●Braking circuit fault or damage to the braking pipes ●The external braking resistor is not sufficient 	<ul style="list-style-type: none"> ●Check the braking unit and , change new braking pipe ●Increase the braking resistor
ETH1	Grounding shortcut fault 1	<ul style="list-style-type: none"> ●The output of the inverter is short circuited with the ground. ●There is fault in the current detection circuit. 	<ul style="list-style-type: none"> ●Check if the connection of the motor is normal or not ●Change the hoare ●Change the main control panel
ETH2	Grounding shortcut fault 2	<ul style="list-style-type: none"> ●The output of the inverter is short circuited with the ground. ●There is fault in the current detection circuit. 	<ul style="list-style-type: none"> ●Check if the connection of the motor is normal or not ●Change the Hoare Change the main control panel
dEu	Speed deviation fault	<ul style="list-style-type: none"> ●The load is too heavy or stalled. 	<ul style="list-style-type: none"> ●Check the load and ensure it is normal. Increase the detection time. ●Check whether the control parameters are normal.
STo	Maladjustment fault	<ul style="list-style-type: none"> ●The control parameters of the synchronous motors not set properly. ●The autoturn parameter is not right. ●The inverter is not connected to the motor. 	<ul style="list-style-type: none"> ●Check the load and ensure it is normal. ●Check whether the control parameter is set properly or not. ●Increase the maladjustment detection time.
END	Running time arrival	<ul style="list-style-type: none"> ●The actual running time of the inverter is above the internal setting running time. 	<ul style="list-style-type: none"> ●Ask for the supplier and adjust the setting running time.

Code	Fault	Cause	Solution
PCE	Keypad communication fault	<ul style="list-style-type: none"> ●The connection of the keypad wires is not good or broken. ●The keypad wire is too long and affected by strong interference. ●There is circuit fault on the communication of the keypad and main board. 	<ul style="list-style-type: none"> ●Check the keypad wires and ensure whether there is mistake. ●Check the environment and avoid the interference source. ●Change the hardware and ask for service.
UPE	Parameters uploading fault	<ul style="list-style-type: none"> ●The connection of the keypad wires is not good or broken. ●The keypad wire is too long and affected by strong interference. ●Communication fault. 	<ul style="list-style-type: none"> ●Check the keypad wires and ensure whether there is mistake. ●Change the hardware and ask for service. ●Change the hardware and ask for service.
DNE	Parameters downloading fault	<ul style="list-style-type: none"> ●The connection of the keypad wires is not good or broken. ●The keypad wire is too long and affected by strong interference. ●There is mistake on the data storage of the keypad. 	<ul style="list-style-type: none"> ●Check the keypad wires and ensure whether there is mistake. ●Change the hardware and ask for service. ●Repack-up the data in the keypad. ●
LL	Electronic underload fault	<ul style="list-style-type: none"> ●The inverter will report the underload pre-alarm according to the set value. 	<ul style="list-style-type: none"> ●Check the load and the underload pre-alarm point.
E-DP	PROFIBUS/CAN open communication fault	<ul style="list-style-type: none"> ●Communication address is not correct. ●Corresponding resistor is not dialed ●The files of main stop GSD does not set sound 	<ul style="list-style-type: none"> ●Check related setting

Code	Fault	Cause	Solution
E-NET	Ethernet communication fault	<ul style="list-style-type: none"> ●The Ethernet address is not set right. ●The Ethernet communication is not selected to right. ●The ambient interference is too strong. 	<ul style="list-style-type: none"> ●Check the relative setting. Check the communication method selection. ●Check the environment and avoid the interference.
E-CAN	CANopen communication fault	<ul style="list-style-type: none"> ●The connection is not sound ●Corresponding resistor is not dialed ●The communication is uneven 	<ul style="list-style-type: none"> ●Check the connection ●Draw out the correspond resistor ●Set the same baud rate

8.6 Common fault analysis

8.6.1 The motor does not work

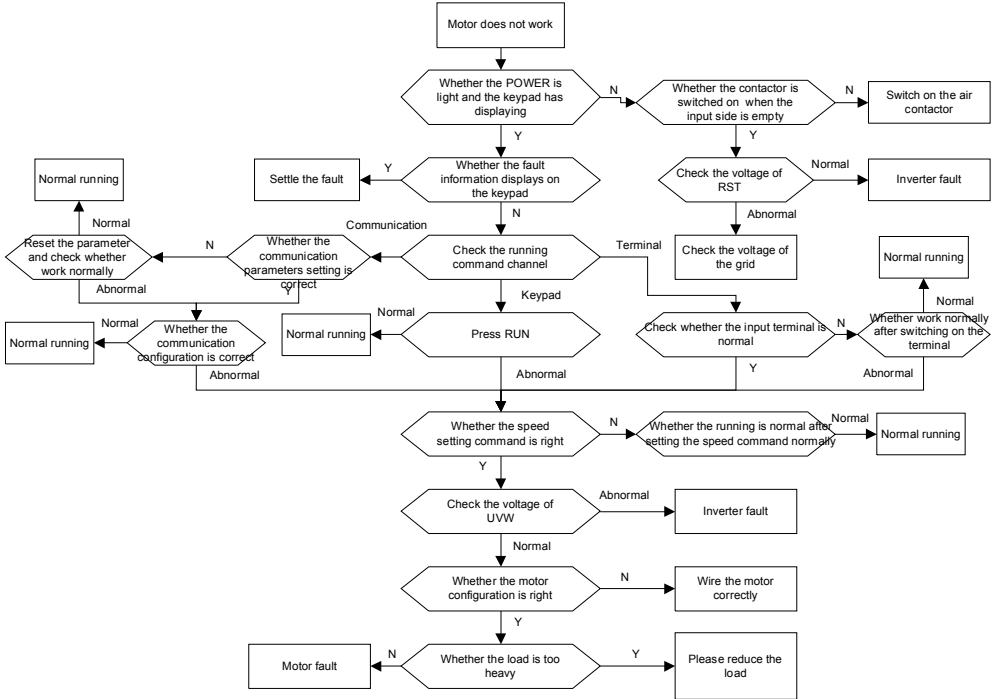

8.6.2 Motor vibration

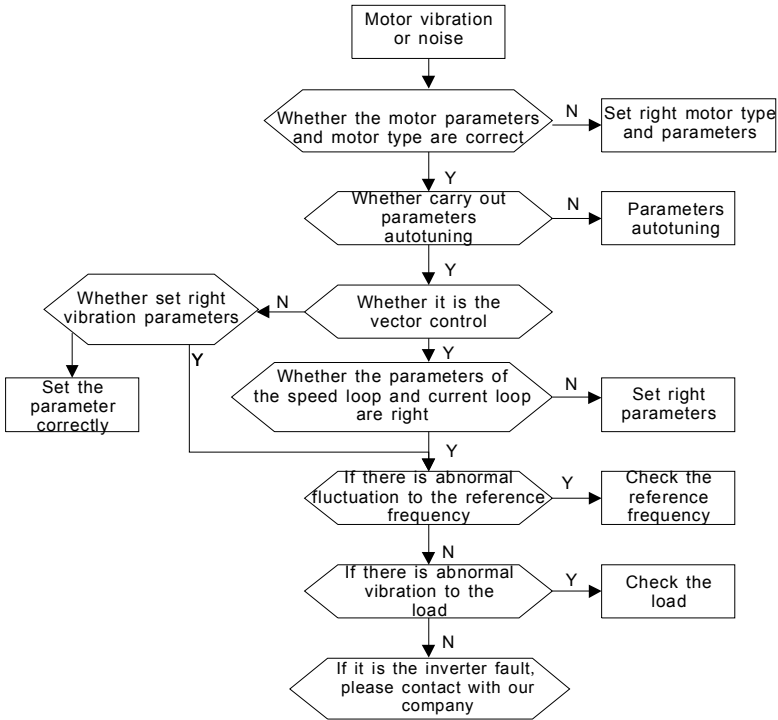

8.6.3 Overvoltage

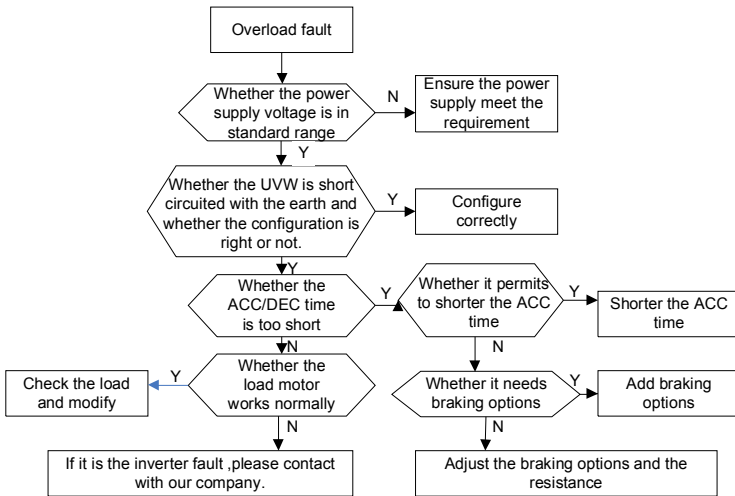

8.6.4 Undervoltage fault

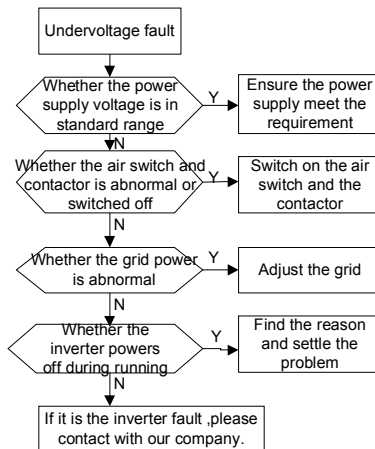

8.6.5 Abnormal heating of the motor

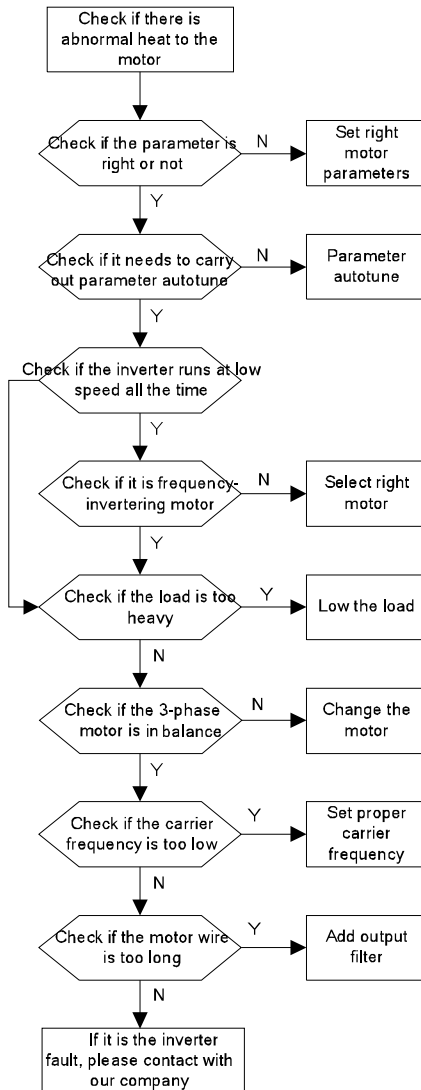

8.6.6 Overheat of the inverter

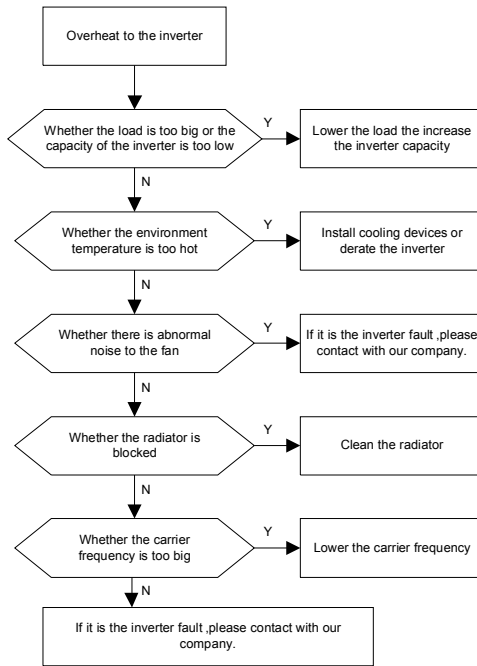

8.6.7 Motor stall during ACC

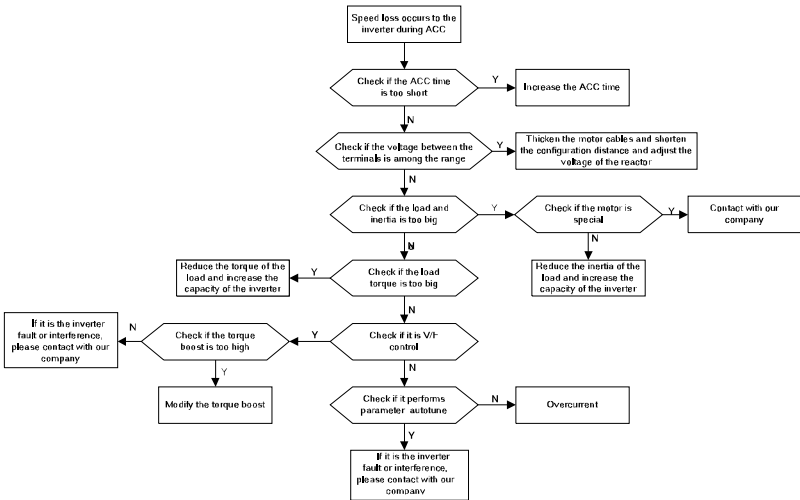

8.6.8 Overcurrent



Maintenance and hardware diagnostics 9

9.1 What this chapter contains.

The chapter contains preventive maintenance instructions of the inverter.

9.2 Maintenance intervals

If installed in an appropriate environment, the inverter requires very little maintenance. The table lists the routine maintenance intervals recommended by INVT.

Checking		Item	Method	Criterion
Ambient environment		Check the ambient temperature, humidity and vibration and ensure there is no dust, gas, oil fog and water drop.	Visual examination and instrument test	Conforming to the manual
		Ensure there are no tools or other foreign or dangerous objects	Visual examination	There are no tools or dangerous objects.
Voltage		Ensure the main circuit and control circuit are normal.	Measurement by millimeter	Conforming to the manual
Keypad		Ensure the display is clear enough	Visual examination	The characters are displayed normally.
		Ensure the characters are displayed totally	Visual examination	Conforming to the manual
Main circuit	For public use	Ensure the screws are tightened security	Tighten up	NA
		Ensure there is no distortion, crackles, damage or color-changing caused by overheating and aging to the machine and insulator.	Visual examination	NA
		Ensure there is no dust and dirtiness	Visual examination	NA Note: if the color of the copper

Checking		Item	Method	Criterion
				blocks change, it does not mean that there is something wrong with the features.
	The lead of the conductors	Ensure that there is no distortion or color-changing of the conductors caused by overheating.	Visual examination	NA
		Ensure that there are no crackles or color-changing of the protective layers.	Visual examination	NA
	Terminals seat	Ensure that there is no damage	Visual examination	NA
	Filter capacitors	Ensure that there is no weeping, color-changing, crackles and cassis expansion.	Visual examination	NA
		Ensure the safety valve is in the right place.	Estimate the usage time according to the maintenance or measure the static capacity.	NA
		If necessary, measure the static capacity.	Measure the capacity by instruments.	The static capacity is above or equal to the original value *0.85.
	Resistors	Ensure whether there is replacement and splitting caused by overheating.	Smelling and visual examination	NA
		Ensure that there is no offline.	Visual examination or remove one	The resistors are in ±10% of the

Checking		Item	Method	Criterion
			ending to coagulate or measure with multimeters	standard value.
	Transformers and reactors	Ensure there is no abnormal vibration, noise and smelling.	Hearing, smelling and visual examination	NA
	Electromagnetism contactors and relays	Ensure whether there is vibration noise in the workrooms.	Hearing	NA
		Ensure the contactor is good enough.	Visual examination	NA
Control circuit	PCB and plugs	Ensure there are no loose screws and contactors.	Fasten up	NA
		Ensure there is no smelling and color-changing.	Smelling and visual examination	NA
		Ensure there are no crackles, damage distortion and rust.	Visual examination	NA
		Ensure there is no weeping and distortion to the capacitors.	Visual examination or estimate the usage time according to the maintenance information	NA
Cooling system	Cooling fan	Estimate whether there is abnormal noise and vibration.	Hearing and Visual examination or rotate with hand	Stable rotation
		Estimate there is no losses screw.	Tighten up	NA

Checking		Item	Method	Criterion
		Ensure there is no color-changing caused by overheating.	Visual examination or estimate the usage time according to the maintenance information	NA
	Ventilating duct	Ensure whether there is stuff or foreign objection in the cooling fan, air vent.	Visual examination	NA

Consult the local service representative for more details on the maintenance. Visit the official website.

9.3 Cooling fan

The inverter’s cooling fan has a minimum life span of 25,000 operating hours. The actual life span depends on the inverter usage and ambient temperature.

The operating hours can be found through P07.15.

Fan failure can be predicted by the increasing noise from the fan bearings. If the inverter is operated in a critical part of a process, fan replacement is recommended once these symptoms appear. Spare fans are also available.

Replacing the cooling fan

	⚠️ Read and follow the instructions in chapter <i>Safety Precautions</i> . Ignoring the instructions would cause physical injury or death, or damage to the equipment.
--	--

1. Stop the inverter and disconnect it from the AC power source and wait for at least the time designated on the inverter.
2. Loose the fan cable from the clip (remove the shell for the inverters of 380V 1.5~30kW).
3. Disconnect the fan cable.
4. Remove the fan.
5. Install the new fan in the inverter, put the fan cables in the clip and then fix the inverter well..
6. Connect the power supply..

9.4 Capacitors

9.4.1 Capacitors reforming

The DC bus capacitors must be reformed according to the operation instruction if the inverter has been stored for a long time. The storing time is counted from the producing date other than the delivery data which has been marked in the serial number of the inverter.

Time	Operational principle
Storing time less than 1 year	Operation without charging
Storing time 1-2 years	Connect with the power for 1 hour before first ON command
Storing time 2-3 years	Use power surge to charge for the inverter <ul style="list-style-type: none"> • charging 25% rated voltage for 30 minutes • charging 50% rated voltage for 30 minutes • charging 75% rated voltage for 30 minutes • charging 100% rated voltage for 30 minutes
Storing time more than 3 years	Use power surge to charge for the inverter <ul style="list-style-type: none"> • charging 25% rated voltage for 2 hours • charging 50% rated voltage for 2 hours • charging 75% rated voltage for 2 hours • charging 100% rated voltage for 2 hours

Use voltage-adjusting power supply to charge the inverter:

The right selection of the voltage-adjusting power supply depends on the supply power of the inverter. Single phase 220V AC/2A power surge is applied to the inverter of single/three-phase 220VAC. The inverter of single/three-phase 220V AC can apply single phase 220V AC/2A power surge(L+ to R, N to S or T). All DC bus capacitors can charge at the same time because there is one rectifier.

High-voltage inverter needs enough voltage (for example, 380V) during charging. The small capacitor power (2A is enough) can be used because the capacitor nearly does not need current when charging.

The operation method of inverter charging through resistors (LEDs):

The charging time is at least 60 minutes if charge the DC bus capacitor directly through supply power. This operation is available on normal temperature and no-load condition and the resistor should be serially connected in the 3-phase circuits of the power supply:

a) 380V driven device: 1k/100W resistor. LED of 100W can be used when the power voltage is no more than 380V. But if used, the light may be off or weak during charging.

b) 660V driven device: 1k/160W resistor.

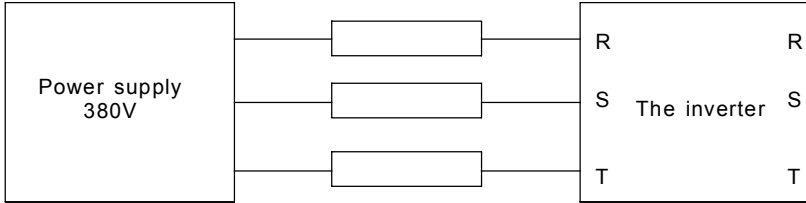

380V charging illustration of the driven device

9.4.2 Change electrolytic capacitors



✧ Read and follow the instructions in chapter *Safety Precautions*. Ignoring the instructions may cause physical injury or death, or damage to the equipment.

Change electrolytic capacitors if the working hours of electrolytic capacitors in the inverter are above 35000. Please contact with the local offices or dial our national service hotline (400-700-9997) for detailed operation.

9.5 Power cable



✧ Read and follow the instructions in chapter *Safety Precautions*. Ignoring the instructions may cause physical injury or death, or damage to the equipment.

1. Stop the drive and disconnect it from the power line. Wait for at least the time designated on the inverter.
2. Check the tightness of the power cable connections.
3. Restore power.

Communication protocol

10

10.1 What this chapter contains

This chapter describes the communication protocol of Goodrive35 series inverters.

The Goodrive35 series inverters provide RS485 communication interface. It adopts international standard ModBus communication protocol to perform master-slave communication. The user can realize centralized control through PC/PLC, upper control PC, etc. (set the control command, running frequency of the inverter, modify relevant function codes, monitor and control the operating state and fault information of the inverter and so on) to adapt specific application requirements.

10.2 Brief instruction to Modbus protocol

Modbus protocol is a software protocol and common language which is applied in the electrical controller. With this protocol, the controller can communicate with other devices via network (the channel of signal transmission or the physical layer, such as RS485). And with this industrial standard, the controlling devices of different manufacturers can be connected to an industrial network for the convenient of being monitored.

There are two transmission modes for Modbus protocol: ASCII mode and RTU (Remote Terminal Units) mode. On one Modbus network, all devices should select same transmission mode and their basic parameters, such as baud rate, digital bit, check bit, and stopping bit should have no difference.

Modbus network is a controlling network with single-master and multiple slaves, which means that there is only one device performs as the master and the others are the slaves on one Modbus network. The master means the device which has active talking right to sent message to Modbus network for the controlling and inquiring to other devices. The slave means the passive device which sends data message to the Modbus network only after receiving the controlling or inquiring message (command) form the master (response). After the master sends message, there is a period of time left for the controlled or inquired slaves to response, which ensure there is only one slave sends message to the master at a time for the avoidance of singles impact.

Generally, the user can set PC, PLC, IPC and HMI as the masters to realize central control. Setting certain device as the master is a promise other than setting by a bottom or a switch or the device has a special message format. For example, when the upper monitor is

running, if the operator clicks sending command bottom, the upper monitor can send command message actively even it can not receive the message form other devices. In this case, the upper monitor is the master. And if the designer makes the inverter send the data only after receiving the command, then the inverter is the slave.

The master can communicate with any single slave or with all slaves. For the single-visiting command, the slave should feedback a response message; for the broadcasting message from the master, the slave does not need to feedback the response message.

10.3 Application of the inverter

The Modbus protocol of the inverter is RTU mode and the physical layer is RS485.

10.3.1 RS485

The interface of RS485 works on semiduplex and its data signal applies differential transmission which is called balance transmission, too. It uses twisted pairs, one of which is defined as A (+) and the other is defined as B (-). Generally, if the positive electrical level between sending drive A and B is among +2~+6V, it is logic“1”, if the electrical level is among -2V~-6V, it is logic“0”.

485+ on the terminal board corresponds to A and 485- to B.

Communication baud rate means the binary bit number in one second. The unit is bit/s (bps).

The higher the baud rate is, the quicker the transmission speed is and the weaker the anti-interference is. If the twisted pairs of 0.56mm (24AWG)is applied as the communication cables, the Max. Transmission distance is as below:

Baud rate	Max. transmission distance	Baud rate	Max. transmission distance
2400BPS	1800m	9600BPS	800m
4800BPS	1200m	19200BPS	600m

It is recommended to use shield cables and make the shield layer as the grounding wires during RS485 remote communication.

In the cases with less devices and shorter distance, it is recommended to use 120Ω terminal resistor as the performance will be weakened if the distance increase even though the network can perform well without load resistor.

10.3.2.1 Single application

Figure 1 is the site Modbus connection figure of single inverter and PC. Generally, the computer does not have RS485 interface, the RS232 or USB interface of the computer should be converted into RS485 by converter. Connect the A terminal of RS485 to the 485+

terminal of the inverter and B to the 485- terminal. It is recommended to use the shield twisted pairs. When applying RS232-RS485 converter, if the RS232 interface of the computer is connected to the RS232 interface of the converter, the wire length should be as short as possible within the length of 15m. It is recommended to connect the RS232-RS485 converter to the computer directly. If using USB-RS485 converter, the wire should be as short as possible, too.

Select a right interface to the upper monitor of the computer (select the interface of RS232-RS485 converter, such as COM1) after the wiring and set the basic parameters such as communication baud rate and digital check bit to the same as the inverter.

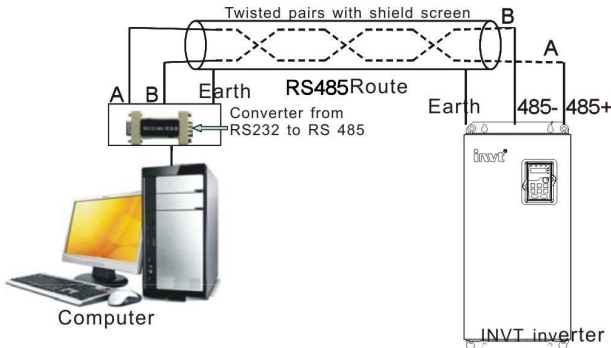

Fig 10-1 RS485 physical connection in single application

10.3.1.2 Multi-application In the real multi-application, the chrysanthemum connection and star connection are commonly used.

Chrysanthemum chain connection is required in the RS485 industrial fieldbus standards. The two ends are connected to terminal resistors of 120Ω which is shown as figure 2. Figure 3 is the simply connection figure and figure 4 is the real application figure.

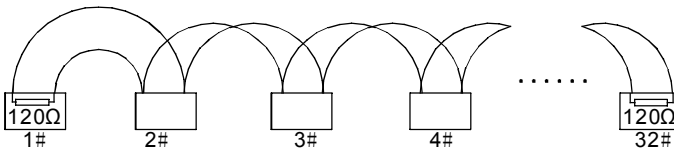

Fig 10-2 Chrysanthemum connection

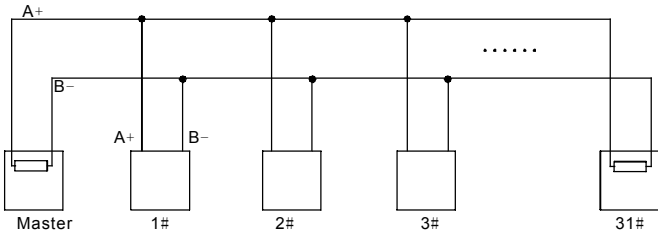

Fig 10-3 Chrysanthemum connection

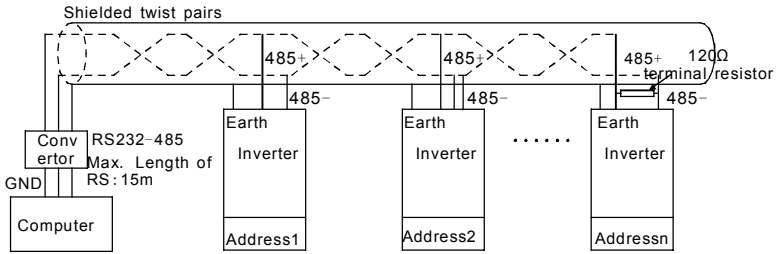

Fig 10-4 Chrysanthemum connection applications

Figure 5 is the star connection. Terminal resistor should be connected to the two devices which have the longest distance. (1# and 15#device)

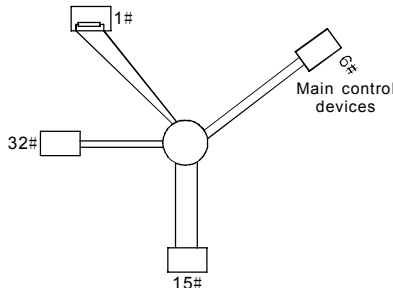

Fig 10-5 star connection

It is recommended to use shield cables in multiple connection. The basic parameter of the devices, such as baud rate and digital check bit in RS485 should be the same and there should be no repeated address.

10.3.2 RTU mode

10.3.2.1 RTU communication frame format

If the controller is set to communicate by RTU mode in Modbus network every 8bit byte in the message includes two 4Bit hex characters. Compared with ACSII mode, this mode can

send more data at the same baud rate.

Code system

- 1 start bit
- 7 or 8 digital bit, the minimum valid bit can be sent firstly. Every 8 bit frame includes two hex characters (0...9, A...F)
- 1 even/odd check bit . If there is no checkout, the even/odd check bit is inexistent.
- 1 end bit (with checkout), 2 Bit(no checkout)

Error detection field

- CRC

The data format is illustrated as below:

11-bit character frame (BIT1~BIT8 are the data bits)

Start bit	BIT1	BIT2	BIT3	BIT4	BIT5	BIT6	BIT7	BIT8	Check bit	End bit
-----------	------	------	------	------	------	------	------	------	-----------	---------

10-bit character frame (BIT1~BIT7 are the data bits)

Start bit	BIT1	BIT2	BIT3	BIT4	BIT5	BIT6	BIT7	Check bit	End bit
-----------	------	------	------	------	------	------	------	-----------	---------

In one character frame, the digital bit takes effect. The start bit, check bit and end bit is used to send the digital bit right to the other device. The digital bit, even/odd checkout and end bit should be set as the same in real application.

The Modbus minimum idle time between frames should be no less than 3.5 bytes. The network device is detecting, even during the interval time, the network bus. When the first field (the address field) is received, the corresponding device decodes next transmitting character. When the interval time is at least 3.5 byte, the message ends.

The whole message frame in RTU mode is a continuous transmitting flow. If there is an interval time (more than 1.5 bytes) before the completion of the frame, the receiving device will renew the uncompleted message and suppose the next byte as the address field of the new message. As such, if the new message follows the previous one within the interval time of 3.5 bytes, the receiving device will deal with it as the same with the previous message. If these two phenomena all happen during the transmission, the CRC will generate a fault message to respond to the sending devices.

The standard structure of RTU frame:

START	T1-T2-T3-T4(transmission time of 3.5 bytes)
ADDR	Communication address: 0~247(decimal system)(0 is the broadcast address)

CMD	03H:read slave parameters 06H:write slave parameters
DATA (N-1) ... DATA (0)	The data of 2*N bytes are the main content of the communication as well as the core of data exchanging
CRC CHK low bit	Detection value:CRC (16BIT)
CRC CHK high bit	
END	T1-T2-T3-T4(transmission time of 3.5 bytes)

10.3.2.1 RTU communication frame error checkout

Various factors (such as electromagnetic interference) may cause error in the data transmission. For example, if the sending message is a logic "1", A-B potential difference on RS485 should be 6V, but in reality, it may be -6V because of electromagnetic interference, and then the other devices take the sent message as logic "0". If there is no error checkout, the receiving devices will not find the message is wrong and they may give incorrect response which cause serious result. So the checkout is essential to the message.

The theme of checkout is that: the sender calculate the sending data according to a fixed formula, and then send the result with the message. When the receiver gets this message, they will calculate another result according to the same method and compare it with the sending one. If two results are the same, the message is correct. If not, the message is incorrect.

The error checkout of the frame can be divided into two parts: the bit checkout of the byte and the whole data checkout of the frame (CRC check).

Bit checkout of the byte

The user can select different bit checkouts or non-checkout, which impacts the check bit setting of each byte.

The definition of even checkout: add an even check bit before the data transmission to illustrate the number of "1" in the data transmission is odd number or even number. When it is even, the check byte is "0", otherwise, the check byte is "1". This method is used to stabilize the parity of the data.

The definition of odd checkout: add an odd check bit before the data transmission to illustrate the number of "1" in the data transmission is odd number or even number. When it is odd, the check byte is "0", otherwise, the check byte is "1". This method is used to stabilize the parity of the data.

For example, when transmitting "11001110", there are five "1" in the data. If the even

checkout is applied, the even check bit is "1"; if the odd checkout is applied; the odd check bit is "0". The even and odd check bit is calculated on the check bit position of the frame. And the receiving devices also carry out even and odd checkout. If the parity of the receiving data is different from the setting value, there is an error in the communication.

CRC check

The checkout uses RTU frame format. The frame includes the frame error detection field which is based on the CRC calculation method. The CRC field is two bytes, including 16 figure binary values. It is added into the frame after calculated by transmitting device. The receiving device recalculates the CRC of the received frame and compares them with the value in the received CRC field. If the two CRC values are different, there is an error in the communication.

During CRC, 0*FFFF will be stored. And then, deal with the continuous 6-above bytes in the frame and the value in the register. Only the 8Bit data in every character is effective to CRC, while the start bit, the end and the odd and even check bit is ineffective.

The calculation of CRC applies the international standard CRC checkout principles. When the user is editing CRC calculation, he can refer to the relative standard CRC calculation to write the required CRC calculation program.

Here provided a simple function of CRC calculation for the reference (programmed with C language):

```
unsigned int crc_cal_value(unsigned char *data_value,unsigned char data_length)
{
int i;
unsigned int crc_value=0xffff;
while(data_length--)
{
  crc_value^=*data_value++;
  for(i=0;i<8;i++)
  {
if(crc_value&0x0001)crc_value=(crc_value>>1)^0xa001;
else crc_value=crc_value>>1;
}
}
return(crc_value);
}
```

In ladder logic, CKSM calculated the CRC value according to the frame with the table inquiry. The method is advanced with easy program and quick calculation speed. But the ROM

space the program occupied is huge. So use it with caution according to the program required space.

10.4 RTU command code and communication data illustration

10.4.1 command code:03H

03H(correspond to binary 0000 0011),read N words(Word)(the Max. continuous reading is 16 words)

Command code 03H means that if the master read data form the inverter, the reading number depends on the “data number” in the command code. The Max. continuous reading number is 16 and the parameter address should be continuous. The byte length of every data is 2 (one word). The following command format is illustrated by hex (a number with “H” means hex) and one hex occupies one byte.

The command code is used to read the working stage of the inverter.

For example, read continuous 2 data content from 0004H from the inverter with the address of 01H (read the content of data address of 0004H and 0005H), the frame structure is as below:

RTU master command message (from the master to the inverter)

START	T1-T2-T3-T4 (transmission time of 3.5 bytes)
ADDR	01H
CMD	03H
High bit of the start bit	00H
Low bit of the start bit	04H
High bit of data number	00H
Low bit of data number	02H
CRC low bit	85H
CRC high bit	CAH
END	T1-T2-T3-T4 (transmission time of 3.5 bytes)

T1-T2-T3-T4 between START and END is to provide at least the time of 3.5 bytes as the leisure time and distinguish two messages for the avoidance of taking two messages as one message.

ADDR = 01H means the command message is sent to the inverter with the address of 01H and ADDR occupies one byte

CMD=03H means the command message is sent to read data form the inverter and CMD occupies one byte

“**Start address**” means reading data form the address and it occupies 2 bytes with the fact that the high bit is in the front and the low bit is in the behind.

“**Data number**” means the reading data number with the unit of word. If the “start address” is 0004H and the “data number” is 0002H, the data of 0004H and 0005H will be read.

CRC occupies 2 bytes with the fact that the high bit is in the front and the low bit is in the behind.

RTU slave response message (from the inverter to the master)

START	T1-T2-T3-T4 (transmission time of 3.5 bytes)
ADDR	01H
CMD	03H
Byte number	04H
Data high bit of address 0004H	13H
Data low bit of address 0004H	88H
Data high bit of address 0005H	00H
Data low bit of address 0005H	00H
CRC CHK low bit	7EH
CRC CHK high bit	9DH
END	T1-T2-T3-T4 (transmission time of 3.5 bytes)

The meaning of the response is that:

ADDR = 01H means the command message is sent to the inverter with the address of 01H and ADDR occupies one byte

CMD=03H means the message is received from the inverter to the master for the response of reading command and CMD occupies one byte

“**Byte number**” means all byte number from the byte (excluding the byte) to CRC byte (excluding the byte). 04 means there are 4 byte of data from the “byte number” to “CRC CHK low bit”, which are “digital address 0004H high bit”, “digital address 0004H low bit”, “digital address 0005H high bit” and “digital address 0005H low bit”.

There are 2 bytes stored in one data with the fact that the high bit is in the front and the low bit is in the behind of the message, the data of data address 0004H is 1388H, and the data of data address 0005H is 0000H.

CRC occupies 2 bytes with the fact that the high bit is in the front and the low bit is in the behind.

10.4.2 Command code:06H

06H(correspond to binary 0000 0110), write one word(Word)

The command means that the master write data to the inverter and one command can write one data other than multiple dates. The effect is to change the working mode of the inverter. For example, write 5000 (1388H) to 0004H from the inverter with the address of 02H, the frame structure is as below:

RTU master command message (from the master to the inverter)

START	T1-T2-T3-T4 (transmission time of 3.5 bytes)
ADDR	02H
CMD	06H
High bit of writing data address	00H
Low bit of writing data address	04H
data content	13H
data content	88H
CRC CHK low bit	C5H
CRC CHK high bit	6EH
END	T1-T2-T3-T4 (transmission time of 3.5 bytes)

RTU slave response message (from the inverter to the master)

START	T1-T2-T3-T4 (transmission time of 3.5 bytes)
ADDR	02H
CMD	06H
High bit of writing data address	00H
Low bit of writing data address	04H
High bit of data content	13H
Low bit of data content	88H
CRC CHK low bit	C5H
CRC CHK high bit	6EH
END	T1-T2-T3-T4 (transmission time of 3.5 bytes)

Note: section 10.2 and 10.3 mainly describe the command format, and the detailed application will be mentioned in 10.8 with examples.

10.4.3 Command code 08H for diagnosis

Meaning of sub-function codes

Sub-function Code	Description
0000	Return to inquire information data

For example: The inquiry information string is same as the response information string when the loop detection to address 01H of driver is carried out.

The RTU request command is:

START	T1-T2-T3-T4 (transmission time of 3.5 bytes)
ADDR	01H
CMD	08H
High bit of sub-function code	00H
Low bit of sub-function code	00H
High bit of data content	12H
Low bit of data content	ABH
Low bit of CRC	ADH
High bit of CRC	14H
END	T1-T2-T3-T4 (transmission time of 3.5 bytes)

The RTU response command is:

START	T1-T2-T3-T4 (transmission time of 3.5 bytes)
ADDR	01H
CMD	08H
High bit of sub-function code	00H
Low bit of sub-function code	00H
High bit of data content	12H
Low bit of data content	ABH
Low bit of CRC	ADH
High bit of CRC	14H
END	T1-T2-T3-T4 (transmission time of 3.5 bytes)

10.4.4 The definition of data address

The address definition of the communication data in this part is to control the running of the inverter and get the state information and relative function parameters of the inverter.

10.4.4.1 The rules of parameter address of the function codes

The parameter address occupies 2 bytes with the fact that the high bit is in the front and the low bit is in the behind. The range of high and low byte are: high byte—00~ffH; low byte—00~ffH. The high byte is the group number before the radix point of the function code and the

low byte is the number after the radix point. But both the high byte and the low byte should be changed into hex. For example P05.06, the group number before the radix point of the function code is 05, then the high bit of the parameter is 05, the number after the radix point 06, then the low bit of the parameter is 06, then the function code address is 0506H and the parameter address of P10.01 is 0A01H.

P10.00	Simple PLC means	0.Stop after running once. The inverter has to be commanded again after finishing a cycle. 1.Run at the final value after running once. After finish a signal, the inverter will keep the running frequency and direction of the last run. 2.Cycle running. The inverter will keep on running until receiving a stop command and then, the system will stop.	0	○
P10.01	Simple PLC memory selection	Simple PLC: Power loss without memory 1.Power loss memory: PLC record the running stage and frequency when power loss.	0	○

Note: PE group is the factory parameter which can not be read or changed. Some parameters can not be changed when the inverter is in the running state and some parameters can not be changed in any state. The setting range, unit and relative instructions should be paid attention to when modifying the function code parameters.

Besides, EEPROM is stocked frequently, which may shorten the usage time of EEPROM. For users, some functions are not necessary to be stocked on the communication mode. The needs can be met on by changing the value in RAM. Changing the high bit of the function code form 0 to 1 can also realize the function. For example, the function code P00.07 is not stocked into EEPROM. Only by changing the value in RAM can set the address to 8007H. This address can only be used in writing RAM other than reading. If it is used to read, it is an invalid address.

10.4.1.2 The address instruction of other function in Modbus

The master can operate on the parameters of the inverter as well as control the inverter, such as running or stopping and monitoring the working state of the inverter.

Below is the parameter list of other functions

Function instruction	Address definition	Data meaning instruction	R/W characteristics
Communication control command	2000H	0001H:forward running	W/R
		0002H:reverse running	
		0003H:forward jogging	

Function instruction	Address definition	Data meaning instruction	R/W characteristics
		0004H:reverse jogging	
		0005H:stop	
		0006H:coast to stop (emergency stop)	
		0007H:fault reset	
		0008H:jogging stop	
The address of the communication setting value	2001H	Communication setting frequency(0~Fmax(unit: 0.01Hz))	W/R
	2002H	PID given, range(0~1000, 1000 corresponds to100.0%)	W/R
	2003H	PID feedback, range(0~1000, 1000 corresponds to100.0%)	W/R
	2004H	Torque setting value (-3000~3000, 1000 corresponds to the 100.0% of the rated current of the motor)	W/R
	2005H	The upper limit frequency setting during forward rotation(0~Fmax(unit: 0.01Hz))	W/R
	2006H	The upper limit frequency setting during reverse rotation(0~Fmax(unit: 0.01Hz))	W/R
	2007H	The upper limit torque of electromotion torque (0~3000, 1000 corresponds to the 100.0% of the rated current of the motor)	W/R
	2008H	The upper limit torque of braking torque (0~3000, 1000 corresponds to the 100.0% of the rated current of the motor)	W/R
	2009H	Special control command word Bit0~1:=00: motor 1 =01: motor 2 =10: motor 3 =11: motor 4 Bit2:=1 torque control =0:speed control Bit3:=1 power consumption clear =0:no power consumption clear Bit4:=1 pre-exciting enabling	W/R

Function instruction	Address definition	Data meaning instruction	R/W characteristics
		=0: pre-exciting disabling Bit5:=1 DC braking enabling =0: DC braking disabling	
	200AH	Virtual input terminal command , range: 0x000~0x1FF	W/R
	200BH	Virtual output terminal command , range: 0x00~0x0F	W/R
	200CH	Voltage setting value(special for V/F separation) (0~1000, 1000 corresponds to the 100.0%)	W/R
	200DH	AO output setting 1 (-1000~1000, 1000 corresponds to 100.0%)	W/R
	200EH	AO output setting 2 (-1000~1000, 1000 corresponds to 100.0%)	W/R
SW 1 of the inverter	2100H	0001H:forward running	R
		0002H:forward running	
		0003H:stop	
		0004H:fault	
		0005H: POFF state	
		0006H: pre-exciting state	
SW 2 of the inverter	2101H	Bit0: =0:ready for operation =1: not ready for operation Bit1~2:=00: motor 1 =01: motor 2 =10: motor 3 =11: motor 4 Bit3: =0: asynchronous motor =1: synchronous motor Bit4:=0: pre-alarm without overload =1: overload pre-alarm Bit5~ Bit6: =00: keypad control =01: terminal control =10: communication control	R

Function instruction	Address definition	Data meaning instruction	R/W characteristics
Fault code of the inverter	2102H	See the fault type instruction	R
Identifying code of the inverter	2103H	Goodrive35----0x0110	R
Operation frequency	3000H	0~Fmax (unit: 0.01Hz)	R
Setting frequency	3001H	0~Fmax (unit: 0.01Hz)	R
Bus voltage	3002H	0.0~2000.0V (unit: 0.1V)	R
Output voltage	3003H	0~1200V (unit: 1V)	R
Output current	3004H	0.0~3000.0A (unit: 0.1A)	R
Rotation speed	3005H	0~65535 (unit: 1RPM)	R
Output power	3006H	-300.0~300.0% (unit: 0.1%)	R
Output torque	3007H	-250.0~250.0% (unit: 0.1%)	R
Close loop setting	3008H	-100.0~100.0% (unit: 0.1%)	R
Close loop feedback	3009H	-100.0~100.0% (unit: 0.1%)	R
Input IO state	300AH	000~1FF	R
Output IO state	300BH	000~1FF	R
Analog input 1	300CH	0.00~10.00V (unit: 0.01V)	R
Analog input 2	300DH	0.00~10.00V (unit: 0.01V)	R
Analog input 3	300EH	0.00~10.00V (unit: 0.01V)	R
Analog input 4	300FH		R
Read input of high-speed pulse 1	3010H	0.00~50.00kHz (unit: 0.01Hz)	R
Read input of high-speed pulse 2	3011H		R
Read the current	3012H	0~15	R

Function instruction	Address definition	Data meaning instruction	R/W characteristics
stage of multi-step speed			
External length	3013H	0~65535	R
External counting	3014H	0~65535	R
Torque setting	3015H	-300.0~300.0% (unit: 0.1%)	R
Identifying code of the inverter	3016H		R
Fault code	5000H		R

R/W characteristics means the function is with read and write characteristics. For example, "communication control command" is writing characteristics and control the inverter with writing command (06H). R characteristic can only read other than write and W characteristic can only write other than read.

Note: when operate on the inverter with the table above, it is necessary to enable some parameters. For example, the operation of running and stopping, it is necessary to set P00.01 to communication running command channel and set P00.02 to MODBUS communication channel. And when operate on "PID given", it is necessary to set P09.00 to "MODBUS communication setting".

The encoding rules for device codes (corresponds to identifying code 2103H of the inverter)

High 8 bit	Meaning	Low 8 bit	Meaning
01	GD	0x08	GD35 vector inverter
		0x09	GD35-H1 vector inverter
		0x0a	GD300 vector inverter
		0x0b	GD100 simple vector inverter
		0x0c	GD200 universal inverter
		0x0d	GD10 mini inverter
		0x0e	GD800 PWM rectifier
		0x0f	GD800 PWM inverter

10.4.5 Fieldbus ratio values

The communication data is expressed by hex in actual application and there is no radix point in hex. For example, 50.12Hz can not be expressed by hex so 50.12 can be magnified by 100 times into 5012, so hex 1394H can be used to express 50.12.

A non-integer can be timed by a multiple to get an integer and the integer can be called

fieldbus ratio values.

The fieldbus ratio values are referred to the radix point of the setting range or default value in the function parameter list. If there are figures behind the radix point (n=1), then the fieldbus ratio value m is 10^n . Take the table as the example:

P01.20	Hibernation restore delay time	This function code determines the Hibernation time. When the running frequency of the Inverter is lower than the lower limit one, the inverter will stop to stand by. When the set frequency is above the lower limit again and it lasts for the time set by P01.20 Inverter will run automatically. Note: The time is the total value when the set frequency is above the lower limit one.	0	0
P01.21	Restart after power off	This function can enable the inverter start or not after the power off and then power on. 0: Disable 1: Enable, if the starting need is met, the inverter will run automatically after waiting for the time defined by P01.22.	0	0

If there is one figure behind the radix point in the setting range or the default value, then the fieldbus ratio value is 10. if the data received by the upper monitor is 50, then the "hibernation restore delay time" is 5.0 (5.0=50 ÷ 10).

If Modbus communication is used to control the hibernation restore delay time as 5.0s. Firstly, 5.0 can be magnified by 10 times to integer 50 (32H) and then this data can be sent.

01	06	01 14	00 32	49 E7
Inverter address	Read command	Parameters address	Data number	CRC check

After the inverter receives the command, it will change 50 into 5 according to the fieldbus ratio value and then set the hibernation restore delay time as 5s.

Another example, after the upper monitor sends the command of reading the parameter of hibernation restore delay time ,if the response message of the inverter is as following:

01	03	02	00 32	39 91
Inverter address	Read command	2-byte data	Parameters data	CRC check

Because the parameter data is 0032H (50) and 50 divided by 10 is 5, then the hibernation restore delay time is 5s.

10.4.6 Fault message response

There may be fault in the communication control. For example, some parameter can only be read. If a writing message is sent, the inverter will return a fault response message.

The fault message is from the inverter to the master, its code and meaning is as below:

Code	Name	Meaning
01H	Illegal	The command from master can not be executed. The reason

Code	Name	Meaning
	command	maybe: 1. This command is only for new device; 2. Slave is in fault state and can not execute it.
02H	Illegal data address.	Some of the operation addresses are invalid or not allowed to access. Especially the combination of the register and the transmitting bytes are invalid.
03H	Illegal value	When there are invalid data in the message framed received by slave. Note: This error code does not indicate the data value to write exceed the range, but indicate the message frame is an illegal frame.
04H	Operation failed	The parameter setting in parameter writing is invalid. For example, the function input terminal can not be set repeatedly.
05H	Password error	The password written to the password check address is not same as the password set by P7.00.
06H	Data frame error	In the frame message sent by the upper monitor, the length of the digital frame is incorrect or the counting of CRC check bit in RTU is different from the lower monitor.
07H	Parameters only for read	It only happen in write command
08H	Parameters can not be changed during running	The modified parameter in the writing of the upper monitor can not be modified during running.
09H	Password protection	When the upper monitor is writing or reading and the user password is set without password unlocking, it will report that the system is locked.

The slave uses functional code fields and fault addresses to indicate it is a normal response or some error occurs (named as objection response). For normal responses, the slave shows corresponding function codes, digital address or sub-function codes as the response. For objection responses, the slave returns a code which equals the normal code, but the first byte is logic 1.

For example: when the master sends a message to the slave, requiring it to read a group of address data of the inverter function codes, there will be following function codes:

0 0 0 0 0 1 1 (Hex 03H)

For normal responses, the slave responds the same codes, while for objection responses, it will return:

1 0 0 0 0 1 1 (Hex 83H)

Besides the function codes modification for the objection fault, the slave will respond a byte of abnormal code which defines the error reason.

When the master receives the response for the objection, in a typical processing, it will send the message again or modify the corresponding order.

For example, set the "running command channel" of the inverter (P00.01, parameter address is 0001H) with the address of 01H to 03, the command is as following:

01	06	00 01	00 03	98 0B
Inverter address	Read command	Parameters address	Parameters data	CRC check

But the setting range of "running command channel" is 0~2, if it is set to 3, because the number is beyond the range, the inverter will return fault response message as below:

01	86	04	43 A3
Inverter address	Abnormal response code	Fault code	CRC check

Abnormal response code 86H means the abnormal response to writing command 06H; the fault code is 04H. In the table above, its name is operation failed and its meaning is that the parameter setting in parameter writing is invalid. For example, the function input terminal can not be set repeatedly.

10.4.7 Example of writing and reading

Refer to 10.4.1 and 10.4.2 for the command format.

10.4.7.1 Example of reading command 03H

Read the state word 1 of the inverter with the address of 01H (refer to table 1). From the table 1, the parameter address of the state word 1 of the inverter is 2100H.

The command sent to the inverter:

01	03	21 00	00 01	8E 36
Inverter address	Read command	Parameters address	Data number	CRC check

If the response message is as below:



The data content is 0003H. From the table 1, the inverter stops.

Watch “the current fault type” to “the previous 5 times fault type” of the inverter through commands, the corresponding function code is P07.27~P07.32 and corresponding parameter address is 071BH~0720H(there are 6 from 071BH).

The command sent to the inverter:



If the response message is as below:

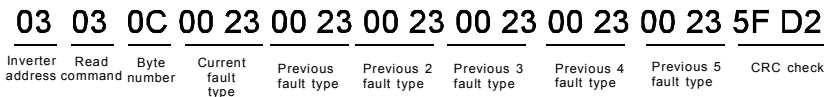

See from the returned data, all fault types are 0023H (decimal 35) with the meaning of maladjustment (STo).

10.4.7.2 Example of writing command 06H

Make the inverter with the address of 03H to run forward. See table 1, the address of “communication control command” is 2000H and forward running is 0001. See the table below.

Function instruction	Address definition	Data meaning instruction	R/W characteristics
Communication control command	2000H	0001H:forward running	W
		0002H:reverse running	
		0003H:forward jogging	
		0004H:reverse jogging	
		0005H:stop	
		0006H:coast to stop (emergency stop)	
		0007H:fault reset	
		0008H:jogging stop	
		0009H:pre-exciting	

The command sent by the master:

03 06 20 00 00 01 42 28
 Inverter address Write command Parameters address Forward running CRC check

If the operation is success, the response may be as below (the same with the command sent by the master):

03 06 20 00 00 01 42 28
 Inverter address Write command Parameters address Forward running CRC check

Set the Max. Output frequency of the inverter with the address of 03H as 100Hz.

P00.03	Max. output frequency	This parameter is used to set the maximum output frequency of the inverter. Users should pay attention to this parameter because it is the foundation of the frequency setting and the speed of acceleration and deceleration. Setting range: P00.04-400.00Hz	50.00Hz	⊙
--------	-----------------------	--	---------	---

See the figures behind the radix point, the fieldbus ratio value of the Max. output frequency (P00.03) is 100. 100Hz timed by 100 is 10000 and the corresponding hex is 2710H.

The command sent by the master:

03 06 00 03 27 10 62 14
 Inverter address Write command Parameters address Parameters data CRC check

If the operation is successful, the response may be as below (the same with the command sent by the master):

03 06 00 03 27 10 62 14
 Inverter address Write command Parameters address Parameters data CRC check

Note: the blank in the above command is for illustration. The blank can not be added in the actual application unless the upper monitor can remove the blank by themselves.

10.5 Common communication fault

Common communication faults: no response to the communication or the inverter returns abnormal fault.

The possible reason for no response to the communication:

Selecting wrong serial interface, for example, if the converter is COM1, selecting COM2 during the communication

The baud rate, digital bit, end bit and check bit are not the same with the inverter + and - of RS485 are connected in reverse.

The 485 wire cap on the terminal board of the inverter is not plug in. the wire cap in behind the terminal arrangement.

Extension card

Appendix A

A.1 What this chapter contains

This chapter describes the extension cards used in Goodrive35 series inverters.

A.2 PROFIBUS/CANOPEN extension card

(1) PROFIBUS/CANOPEN is an open international fieldbus standard that allows data exchange among various types of automation components. It is widely used in manufacturing automation, process automation and in other automation areas such as buildings, transportation, power, providing an effective solution for the realization of comprehensive automation and site-equipment intellectualization.

(2) PROFIBUS/CANOPEN is composed of three compatible components, PROFIBUS/CANOPEN-DP (Decentralized Periphery, distributed peripherals), PROFIBUS/CANOPEN-PA (Process Automation), PROFIBUS/CANOPEN-FMS (Fieldbus Message Specification). It is periodically exchange data with the inverter when using master-slave way. PRNV PROFIBUS/CANOPEN-DP Adapter module only supports PROFIBUS/CANOPEN-DP protocol.

(3) The physical transmission medium of bus is twisted-pair (in line with RS-485 standard), two-wire cable or fiber optic cable. Baud rate is from 9.6Kbit/s to 12Mbit/s. The maximum bus cable length is between 100 m and 1200 m, specific length depending on the selected transmission rate (see chapter *Technical Data*). Up to 31 nodes can be connected to the same PROFIBUS/CANOPEN network when repeaters aren't used. But, if use repeaters, up to 127 nodes can be connected to the same PROFIBUS/CANOPEN network segment (including repeaters and master stations).

(4) In the process of PROFIBUS/CANOPEN communication, tokens are assigned among main stations and master-slave transmission among master-slave stations. Supporting single-master or multi-master system, stations-programmable logic controller (PLC)-choose nodes to respond to the host instruction. Cycle master-from user data transmission and non-cyclic master-master station can also send commands to multiple nodes in the form of broadcast. In this case, the nodes do not need to send feedback signals to the host. In the PROFIBUS/CANOPEN network, communication between nodes can not be allowed.

(5) PROFIBUS/CANOPEN protocol is described in detail in EN 50170 standard. To obtain more information about PROFIBUS/CANOPEN, please refer to the above-mentioned EN 50170 standards.

A.2.1 Product naming rules

Fieldbus adapter naming rules, the product model:

EC-TX 1 03

① ② ③ ④

No.	Instruction	Meaning
①	Product type	EC: extension card
②	Card type	TX: communication card
③	Technical	Odds such as 1,3,5,7 means the 1 st , 2 nd , 3 rd , 4 th technical version
④	Card difference	03: PROFIBUS/CANOPEN+Ethernet communication card 04: Ethernet+CAN communication card

A.2.2 EC-TX-103 communication card

EC-TX-103 communication card is an optional device to inverter which makes inverter connected to PROFIBUS network. In PROFIBUS network, inverter is a subsidiary device.

The following functions can be completed using EC-TX-103 communication card:

- Send control commands to inverter (start, stop, fault reset, etc.).
- Send speed or given torque signal to inverter.
- Read state and actual values from inverter.
- Modify inverter parameter.

Please refer to the description of function codes in Group P15 for the commands supported by the inverter. Below is the structure diagram of the connection between the inverter and PROFIBUS/CANOPEN:

A.2.3 The appearance of EC-TX-103 communication card

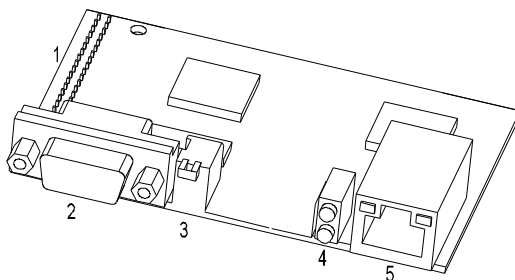

Outline diagram of EC-TX-103 communication card

1. Interface to the panel

2. Bus connector
3. Rotation node address selection switches
4. State display LEDs
5. Ethernet communication interface

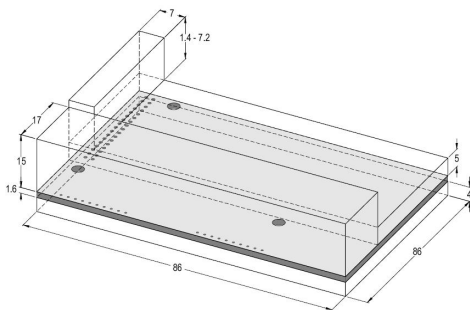

External dimensions of EC-TX-103 communication card (Unit: mm)

A.2.4 Compatible motor of EC-TX-103 communication card

EC-TX-103 communication card is compatible with the following products:

- Goodrive35 series devices and all blasters supporting PROFIBUS/CANOPEN extension
- Host station supporting PROFIBUS/CANOPEN-DP protocol

A.2.5 Delivery list

The package of EC-TX-103 communication card contains:

- EC-TX-103 communication card
- Three copper columns (M3x10)
- User's manual

Please contact with SHENZHEN INVT ELECTRIC CO., LTD or suppliers if there is something missing. Notice will not be given for the reason of product upgrades.

A.2.6 Installation of EC-TX-103 communication card

A.2.6.1 Mechanical installation of EC-TX-103 communication card

1. Installation ambient

- Ambient temperature: $0^{\circ}\text{C} \sim +40^{\circ}\text{C}$
- Relative humidity: 5%~95%
- Other climate conditions: no dew, ice, rain, snow, hail air condition and the solar radiation is below $700\text{W}/\text{m}^2$, air pressure $70\sim 106\text{kPa}$

- Content of salt spray and corrosive gases :Pollution degree 2
- Dust and solid particles content: Pollution degree 2
- Vibration and shock: 5.9m/s^2 (0.6g) on 9~200Hz sinusoidal vibration

2. Installation steps:

- Fix the three copper columns on the location holes with screws.
- Insert the module into the defined location carefully and fix it on the copper column with screw.
- Set the bus terminal switch of the module to the needed location.

3. Notes:

Disconnect the device from the power line before installation. Wait for at least three minutes to let the capacitors discharge. Cut off dangerous voltage from external control circuit to the unit output and input terminals.

Some electric components are sensitive to static charge. Do not touch the circuit board. If you have to operate on it, please wear the grounding wrist belt.

A.2.6.2 Electrical installation of EC-TX-103 communication card

1. Node selection

Node address is the only address of PROFIBUS/CANOPEN on the bus. The address which is among 00~99 is shown with two figures and is selected by the spinning switch on the module. The left switch shows the first number and the right one show the second number.

Node address = 10 x the first digital value + the second digital value x 1

2. Bus terminals

There is a bus terminal in each heading and ending to avoid error during operation. The DIP switch on RPBA-01PCB is used to connect the bus terminals which can avoid the signal feedback from the bus cables. If the module is the first or last one in the internet, the bus terminal should be set as ON. Please disconnect EC-TX-103 communication card terminals when the PROFIBUS/CANOPEN D-sub connector with internal terminals is in use.

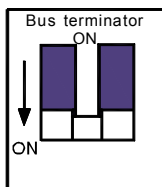
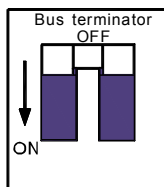

A.2.6.3 Bus net connection of EC-TX-103 communication card

Bus communication interface

Transformation by double-shielded twisted pair copper cable is the most common way in PROFIBUS/CANOPEN (conform to RS-485standard).

The basic characteristics of transformation technology:

- Net topology: Linear bus, there are bus resistor in two ends.
- Transforming speed: 9.6k bit/s~12M bit/s
- Medium: double-shielded twisted pair cables,the shield can be removed according to the environment (EMC).
- Station number: There are 32 stations in each segment (without relays) as to 127 stations (with relays)
- Contact pin: 9 frames D pin, the connector contact pins are as below.:

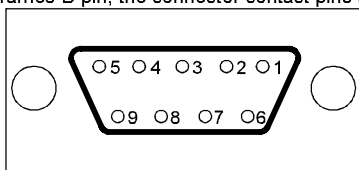

Contact pin of the connector		Instruction
1	-	Unused
2	-	Unused
3	B-Line	Positive data(twisted pair cables 1)
4	RTS	Sending requirement
5	GND_BUS	Isolation ground
6	+5V BUS	Isolated 5V DC power supply
7	-	Unused
8	A-Line	Negative data(twisted pair cables 2)
9	-	Unused
Housing	SHLD	PROFIBUS/CANOPEN shielded cable

+5V and GND_BUS are used in the fieldbus terminals. Some devices, such as light transceiver (RS485) may get external power supply form these pins.

RTS is used in some devices to determine the sending direction. Only A-Line wires, B-Line wires and shield are used in the normal application.

It is recommended to apply the standard DB9 connector of SIEMENS. If the communication baud rate is above 187.5kbps, please follow the connection rules of SIEMENS seriously.



Available

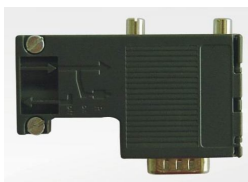

Not available (with interference to the keypad wiring)

Repeater

Up to 32 stations can be connected to each segment (master station or subsidiary stations), the repeater have to be used when stations is more than 32. The repeaters in series are generally no more than 3.

Note: There is no repeater station address.

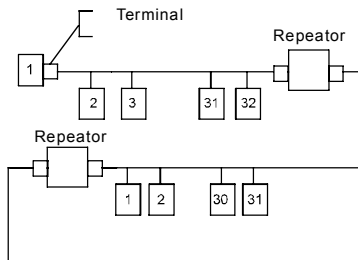

A.2.6.4 Transmission rate and maximum distance

Maximum length of cable depends on the transmission rate. The Table below shows the relationship between transmission rate and distance.

Transmission rate (kbps)	A-wire (m)	B-wire (m)
9.6	1200	1200
19.2	1200	1200
93.75	1200	1200
187.5	1000	600
500	400	200
1500	200	---
12000	100	---

Transmission line parameters:

Transmission rate (kbps)	A-wire (m)	B-wire (m)
Impedance (Ω)	135~165	100~130
Capacitance per unit length(pF/m)	< 30	< 60
Loop Resistance (Ω /km)	110	-----
Core wire diameter (mm)	0.64	> 0.53
Line-core cross-section (mm^2)	> 0.34	> 0.22

Besides shielding twisted-pair copper wires, PROFIBUS/CANOPEN can also use optical fiber for transmission in an electromagnetic interference environment to increase the high-speed transmission distance there are two kinds of fiber optical conductors, one is low-cost plastic fiber conductor, used distance is less than 50 meters, the other is glass fiber conductor, and used distance is less than 1 km.

A.2.6.5 PROFIBUS/CANOPEN bus connection diagram

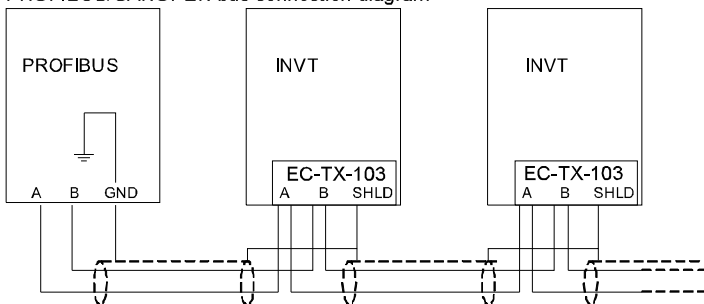

Above is "terminal" wiring diagram. Cable is a standard PROFIBUS/CANOPEN cable consisting of a twisted pair and shielding layer. The shielded layer of PROFIBUS/CANOPEN cable on all nodes is directly grounded. Users can choose the best grounding method according to the situation.

Note:

Make sure that signal lines do not twist when connecting all stations. Shielded cable should be used when system runs under high electromagnetic interface environment, which can improve electromagnetic compatibility (EMC).

If using shielded braided wire and shielding foil, both ends should be connected to ground. Using shielding area should be large enough to maintain a good conductivity. And data lines must be separated from high-voltage.

Stub line segment should not be used when transmission rate more than 500K bit/s, The plug is available on the market which connects directly to data input and output cable. Bus plug connection can be on or off at any time without interruption of data communications of

other station.

A.2.7 System configuration

1. Master station and inverter should be configured so that the master station can communicate with the module after correctly installing EC-TX-103 communication card.

Each PROFIBUS/CANOPEN subsidiary station on the PROFIBUS/CANOPEN bus need to have "device description document" named GSD file which used to describe the characteristics of PROFIBUS/CANOPEN-DP devices. The software we provided for the user includes inverter related GSD files (device data files) information, users can obtain type definition file (GSD) of master machines from local INVT agent.

Configuration parameters of EC-TX-103 communication card:

Parameter number	Parameter name	Optional setting	Factory setting													
0	Module type	Read only	PROFIBUS/CANOP EN-DP													
1	Node address	0~99	2													
2	Baud rate setting	<table border="1"> <tr> <td rowspan="5">kbit/s</td> <td>0:9.6</td> </tr> <tr> <td>1:19.2</td> </tr> <tr> <td>2:45.45</td> </tr> <tr> <td>3:93.75</td> </tr> <tr> <td>4:187.5</td> </tr> <tr> <td rowspan="5">Mbit/s</td> <td>5:500</td> </tr> <tr> <td>6:1.5</td> </tr> <tr> <td>7:3</td> </tr> <tr> <td>8:6</td> </tr> <tr> <td>9:9</td> </tr> <tr> <td>10:12</td> </tr> </table>	kbit/s	0:9.6	1:19.2	2:45.45	3:93.75	4:187.5	Mbit/s	5:500	6:1.5	7:3	8:6	9:9	10:12	6
kbit/s	0:9.6															
	1:19.2															
	2:45.45															
	3:93.75															
	4:187.5															
Mbit/s	5:500															
	6:1.5															
	7:3															
	8:6															
	9:9															
10:12																
3	PZD3	0~65535	0													
4	PZD4	lbid	0													
...	lbid	0													
10	PZD12	lbid	0													

2. Module type

This parameter shows communication module type detected by inverter; users can not adjust this parameter. If this parameter is not defined, communication between the modules and inverter can not be established.

3. Node address

In PROFIBUS/CANOPEN network, each device corresponds to a unique node address, you can use the node address selection switch to define node address (switch isn't at 0) and the parameter is only used to display the node address.

If node address selection switch is 0, this parameter can define node address. The user can not adjust the parameter by themselves and the parameter is only used to display the node address.

4. GSD file

In PROFIBUS/CANOPEN network, each PROFIBUS/CANOPEN subsidiary station needs GSD file "device description document" which used to describe the characteristics of PROFIBUS/CANOPEN-DP devices. GSD file contains all defined parameters, including baud rate, information length, amount of input/output data, meaning of diagnostic data.

A CD-ROM will be offered in which contains GSD file (extension name is .gsd) for fieldbus adapter. Users can copy GSD file to relevant subdirectory of configuration tools, please refer to relevant system configuration software instructions to know specific operations and PROFIBUS/CANOPEN system configuration.

A.2.8 PROFIBUS-DP communication

1. PROFIBUS-DP

PROFIBUS-DP is a distributed I/O system, which enables master machine to use a large number of peripheral modules and field devices. Data transmission shows cycle: master machine read input information from subsidiary machine then give feedback signal. EC-TX-103 communication card supports PROFIBUS-DP protocol.

2. Service access point

PROFIBUS-DP has access to PROFIBUS data link layer (Layer 2) services through service access point SAP. Every independent SAP has clearly defined function. Please refer to relevant PROFIBUS user manual to know more about service access point information. PROFIDRIVE-Variable speed drive adopts PROFIBUS model or EN50170 standards (PROFIBUS protocol).

3. PROFIBUS -DP information frame data structures

PROFIBUS-DP bus mode allows rapid data exchange between master station and inverter. Adopting master-slave mode dealing with inverter access, inverter is always subsidiary station, and each has definite address. PROFIBUS periodic transmission messages use 16 words (16 bit) transmission, the structure shown in figure1.

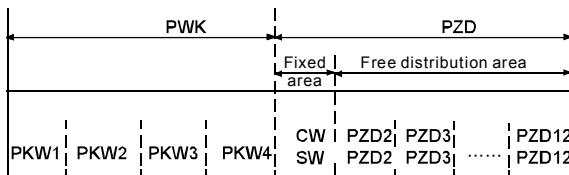

Parameters area:

PKW1-Parameter identification

PKW2-array index number

PKW3-parameter value 1

PKW4-parameter value 2

Process data:

CW-Control word (from master to slave, see Table 1)

SW-state word (from slave to master, see Table 3)

PZD-process data (decided by users) (From master to slave output **【given value】** , from slave to master input **【actual value】**)

PZD area (process data area)

PZD area of communication message is designed for control and monitor inverter. PZD from master and slave station is addressed in high priority; the priority of dealing with PZD is superior to that of PKW, and always sends current valid date from interface.

Control word (CW) and state word (SW)

Control word (CW) is a basic method of fieldbus system controlling inverter. It is sent by the fieldbus master station to inverter and the EC-TX-103 communication cards act as gateway. Inverter responds according to the control word and gives feedbacks to master machine through state word (SW).

Contents of control word and state word are shown in table 4.6 and table 4.7 respectively. Please refer to inverter manual to know bit code.

Given value

Inverter can receive control information by several ways, these channels include: analog and digital input terminals, inverter control board and module communication (such as RS485, EC-TX-103 communication cards). In order to use PROFIBUS/CANOPEN control inverter, the communication module must be set to be inverter controller.

Contents of set value are shown in Table 4.6.

Actual value

Actual value is a 16-bit word, which contains converter operation information. Monitoring

capabilities are defined by inverter parameter. The integer scaling of actual value is sent to master machine depending on selected function, please refer to inverter manual.

Contents of actual values are shown in Table 5.4.

Note: inverter always check the control word (CW) and bytes of given value.

Mission message (From master station to inverter)

Control word (CW)

The first word of PZD is control word (CW) of inverter; due to different control word (CW) of PWM rectifier regenerative part and inverter part Illustration is depart in next two tables.

Control word (CW) of Goodrive35

Bit	Name	Value	State/Description
0~7	COMMAND BYTE	1	Forward running
		2	Reverse running
		3	Forward jogging
		4	Reverse jogging
		5	Decelerate to stop
		6	Coast to stop (Emergency stop)
		7	Fault reset
		8	Jogging stop
8	WRITE ENABLE	1	Write enable (mainly is PKW1-PKW4)
9~10	MOTOR GROUP SELECTION	00	MOTOR GROUP 1 SELECTION
		01	MOTOR GROUP 2 SELECTION
		02	MOTOR GROUP 3 SELECTION
		03	MOTOR GROUP 4 SELECTION
11	TORQUE CONTROL SELECTION	1	Torque control enable
		0	Torque control disable
12	ELECTRIC CONSUMPTION CLEAR	1	Electric consumption clear enable
		0	Electric consumption clear disable
13	PRE-EXCITATION	1	Pre-excitation enable
		0	Pre-excitation disable
14	DC BRAKE	1	DC braking enable
		0	DC braking disable
15	HEARTBEAT REF	1	Heartbeat enable

Bit	Name	Value	State/Description
		0	Heartbeat disable

Reference value (REF):

From 2nd word to 12th of PZD task message is the main set value REF, main frequency set value is offered by main setting signal source. As PWM rectifier feedback part doesn't have main frequency setting part, corresponding settings belong to reserved part, the following table shows inverter part settings for Goodrive35.

Bit	Name	Function selection
PZD2 receiving	0:Invalid 1:Set frequency(0~Fmax(unit:0.01Hz))	0
PZD3 receiving	2:Given PID, range(0~1000,1000 corresponds to 100.0%)	0
PZD4 receiving	3:PID feedback, range(0~1000,1000 corresponds to 100.0%)	0
PZD5 receiving	4:Torque set value(-3000~3000,1000 corresponds to 100.0% the rated current of the motor)	0
PZD6 receiving	5:Set value of the forward rotation upper-limit frequency(0~Fmax unit:0.01Hz))	0
PZD7 receiving	6:Set value of the reversed rotation upper-limit frequency(0~Fmax(unit:0.01Hz))	0
PZD8 receiving	7:Electromotion torque upper limit (0~3000,1000 corresponds to 100.0%of the rated current of the motor)	0
PZD9 receiving	8:Braking torque upper limit (0~2000,1000 corresponds to 100.0% of the rated current of the motor)	0
PZD10 receiving	9:Virtual input terminals command Range:0x000~0x1FF	0
PZD11 receiving	10:Virtual output terminals command Range:0x00~0x0F	0
PZD12 receiving	11:Voltage setting value(special for V/F separation) (0~1000,1000 corresponds to 100.0% the rated voltage of the motor) 12:AO output set value 1 (-1000~1000,1000 corresponds to 100.0%) 13:AO output set value 2	0

Bit	Name	Function selection
	(-1000~1000,1000 corresponds to 100.0%)	

State word (SW):

The first word of PZD response message is state word (SW) of inverter, the definition of state word is as follows:

State Word (SW) of Goodrive35 (SW)

Bit	Name	Value	State/Description
0~7	RUN STATE BYTE	1	Forward running
		2	Reverse running
		3	The inverter stops
		4	The inverter is in fault
		5	The inverter is in POFF state
		6	Pre-exciting state
8	DC VOLTAGE ESTABLISH	1	Running ready
		0	The running preparation is not ready
9~10	MOTOR GROUP FEEDBACK	0	Motor 1 feedback
		1	Motor 2 feedback
		2	Motor 3 feedback
		3	Motor 4 no feedback
11	MOTOR TYPE FEEDBACK	1	Synchronous motor
		0	Asynchronous motor
12	OVERLOAD ALARM	1	Overload pre-alarm
		0	Non-overload pre-alarm
13	RUN/STOP MODE	0	Keypad control
		1	Terminal control
14		2	Communication control
		3	Reserved
15	HEARTBEAT FEEDBACK	1	Heartbeat feedback
		0	No heartbeat feedback

Actual value (ACT):

From 2nd word to 12th of PZD task message is main set value ACT, main frequency set value is offered by main setting signal source.

Actual value of Goodrive35

Bit	Name	Function selection
PZD2 sending	0: Invalid 1: Running frequency(*100, Hz)	0
PZD3 sending	2: Set frequency(*100, Hz) 3: Bus voltage(*10, V)	0
PZD4 sending	4: Output voltage(*1, V) 5: Output current (*10, A)	0
PZD5 sending	6: Output torque actual value(*10, %)	0
PZD6 sending	7: Output power actual value (*10, %)	0
PZD7 sending	8: Running rotating speed(*1, RPM) 9: Running linear speed (*1, m/s)	0
PZD8 sending	10: Ramp given frequency 11: Fault code	0
PZD9 sending	12: AI1 value (*100, V) 13: AI2 value (*100, V)	0
PZD10 sending	14: AI3 value (*100, V) 15: PULSE frequency value (*100, kHz)	0
PZD11 sending	16: Terminals input state 17: Terminals output state	0
PZD12 sending	18: PID given (*100, %) 19: PID feedback (*100, %) 20: Motor rated torque	0

PKW area (parameter identification marks PKW1-value area). PKW area describes treatment of parameter identification interface, PKW interface is a mechanism which determine parameters transmission between two communication partners, such as reading and writing parameter values.

Structure of PKW area:

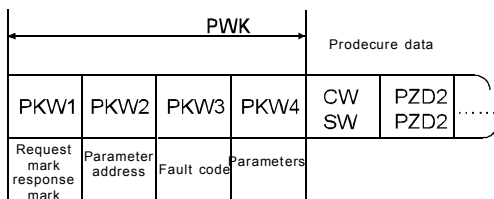

Parameter identification zone

In the process of periodic PROFIBUS/CANOPEN-DP communication, PKW area is composed of four words (16 bit), each word is defined as follows:

The first word PKW1 (16 bit)		
Bit 15~00	Task or response identification marks	0~7
The second word PKW2 (16 bit)		
Bit 15~00	Basic parameters address	0~247
The third word PKW3 (16 bit)		
Bit 15~00	Parameter value (high word) or return error code value	00
The fourth word PKW4 (16 bit)		
Bit 15~00	Parameter value (low word)	0~65535

Note: If the master requests one parameter value, the value of PKW3 and PKW4 will not be valid.

Task requests and responses

When passing data to slave machine, master machine use request label while slave machine use response label to positive or negative confirmation. Table 5.5 and Table 5.6 list the request/response functional.

The definition of task logo PKW1 is as follows:

Definition of task logo PKW1

Request label (From master to slave)		Response label	
Request	Function	Positive confirmation	Negative confirmation
0	No task	0	—
1	Request parameter value	1,2	3
2	Modification parameter value (one word) [only change RAM]	1	3 or 4

Request label (From master to slave)		Response label	
3	Modification parameter value (double word) [only change RAM]	2	3 or 4
4	Modification parameter value (one word) [RAM and EEPROM are modified]	1	3 or 4
5	Modification parameter value (double word) [RAM and EEPROM are modified]	2	3 or 4

Request label

"2"-modification parameter value (one word) [only change RAM],

"3"-modification parameter value (double word) [only change RAM]

"5"-modification parameter value (double word) [RAM and EPROM are modified] not support currently.

Reponses logo PKW1 defines as below:

Response label (From slave to master)	
Confirmation	Function
0	No response
1	Transmission parameter value (one word)
2	Transmission parameter value (two words)
3	Task can not be executed and returns the following error number: 0: Illegal parameter number 1: Parameter values can not be changed (read-only parameter) 2: Out of set value range 3: The sub-index number is not correct 4: Setting is not allowed (only reset) 5: Data type is invalid 6: The task could not be implemented due to operational state 7: Request isn't supported. 8: Request can't be completed due to communication error 9: Fault occurs when write operation to stationary store 10: Request fails due to timeout 11: Parameter can not be assigned to PZD 12: Control word bit can't be allocated 13: Other errors

Response label (From slave to master)	
Confirmation	Function
4	No parameter change rights

Example 1: Read parameter value

Read keypad set frequency value (the address of keypad set frequency is 4) which can be achieved by setting PKW1 as 1, PKW2 as 4, return value is in PKW4.

Request (From master to inverter):

	PKW1	PKW2	PKW3	PKW4	CW	PZD2	PZD3	...	PZD12
Request	00 01	00 04	00 00	00 00	xx xx	xx xx	xx xx	...	xx xx

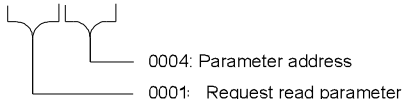

Response (From inverter to master)

	PKW1	PKW2	PKW3	PKW4	CW	PZD2	PZD3	...	PZD12
Response	00 01	00 04	00 00	50 00	xx xx	xx xx	xx xx	...	xx xx

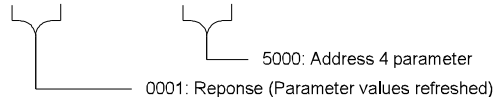

Example 2: Modify the parameter values (RAM and EEPROM are modified)

Modify keypad settings frequency value (the address of keypad set frequency is 4) which can be achieved by setting PKW1 as 2; PKW2 as 4, modification value (50.00) is in PKW4.

Request (From master to inverter):

	PKW1	PKW2	PKW3	PKW4	CW	PZD2	PZD3	...	PZD12
Request	00 02	00 04	00 00	50 00	xx xx	xx xx	xx xx	...	xx xx

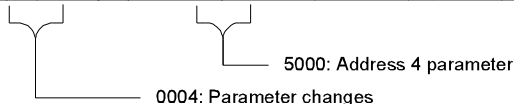

Response (From inverter to master)

	PKW1	PKW2	PKW3	PKW4	CW	PZD2	PZD3	...	PZD12
Response	00 01	00 04	00 00	50 00	xx xx	xx xx	xx xx	...	xx xx

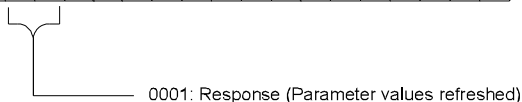

Example for PZD:

Transmission of PZD area is achieved through inverter function code; please refer to relevant INVT inverter user manual to know relevant function code.

Example 1: Read process data of inverter

Inverter parameter selects "8: Run frequency" as PZD3 to transmit which can be achieved by setting Pd.14 as 8. This operation is mandatory until the parameter is instead of others.

Request (From master to inverter):

	PKW1		PKW2		PKW3		PKW4		CW		PZD2		PZD3		...	PZD12	
Response	xx	xx	xx	xx	xx	xx	xx	xx	xx	xx	xx	xx	00	0A	...	xx	xx

Example 2: Write process data into inverter

Inverter parameter selects "2": Traction given" from PZD3 which can be achieved by setting Pd.03 as 2. In each request frame, parameters will use PZD3 to update until re-select a parameter.

Request (From master to converter):

	PKW1		PKW2		PKW3		PKW4		CW		PZD2		PZD3		...	PZD12	
Response	xx	xx	xx	xx	xx	xx	xx	xx	xx	xx	xx	xx	00	00	...	xx	xx

In each request frame contents of PZD3 are given by traction until re-select a parameter.

A.2.9 Fault information

EC-TX-103 communication card is equipped with 2 fault display LEDs as shown is figure below. The roles of these LEDs are as follows:

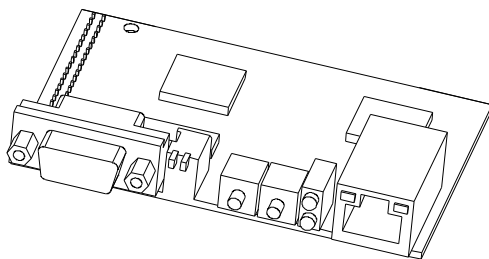

Fault display LEDs

LED No.	Name	Color	Function
2	Online	Green	ON-module online and data can be exchanged. OFF-module is not in "online" state.
4	Offline/Fault	Red	ON-module offline and data can't be exchanged. OFF-module is not in "offline" state. 1. Flicker frequency 1Hz-configuration error: The length of user parameter data sets is different from that

LED No.	Name	Color	Function
			<p>of network configuration process during module initialization process.</p> <p>2. Flicker frequency 2Hz-user parameter data error: The length or content of user parameter data sets is different from that of network configuration process during module initialization process.</p> <p>3. Flicker frequency 4Hz-PROFIBUS/CANOPEN communication ASIC initialization error.</p> <p>4. OFF-Diagnostic closed.</p>

A.3 CANopen optional cards

Refer to the operation manual of EC-TX105 CANopen communication cards.

Technical data

Appendix B

B.1 What this chapter contains

This chapter contains the technical specifications of the inverter, as well as provisions for fulfilling the requirements for CE and other marks.

B.2 Ratings

B.2.1 Capacity

Inverter sizing is based on the rated motor current and power. To achieve the rated motor power given in the table, the rated current of the inverter must be higher than or equal to the rated motor current. Also the rated power of the inverter must be higher than or equal to the rated motor power. The power ratings are the same regardless of the supply voltage within one voltage range.

Note:

1. The maximum allowed motor shaft power is limited to $1.5 \cdot P_N$. If the limit is exceeded, motor torque and current are automatically restricted. The function protects the input bridge of the drive against overload.
2. The ratings apply at ambient temperature of 40 °C
3. It is important to check that in Common DC systems the power flowing through the common DC connection does not exceed P_N .

B.2.2 Derating

The load capacity decreases if the installation site ambient temperature exceeds 40 °C, the altitude exceeds 1000 meters or the switching frequency is changed from 4 kHz to 8, 12 or 15 kHz.

B.2.2.1 Temperature derating

In the temperature range +40 °C...+50 °C, the rated output current is decreased by 3% for every additional 1 °C. Refer to the below list for the actual derating.

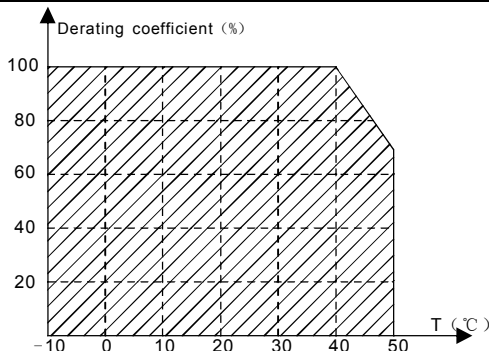

B.2.2.2 Altitude derating

The device can output rated power if the installation site below 1000m. The output power decreases if the altitude exceeds 1000 meters. Below is the detailed decreasing range of the derating:

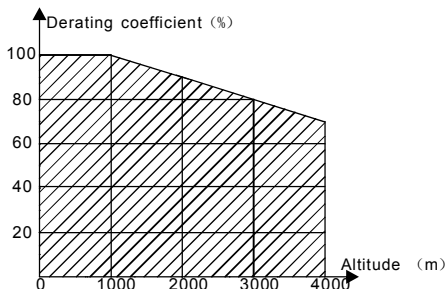

For 3-phase 200 V drives, the maximum altitude is 3000 m above sea level. In altitudes 2000...3000 m, the derating is 2% for every 100 m.

B.2.2.3 Carrier frequency derating

For Goodrive35 series inverters, different power level corresponds to different carrier frequency range. The rated power of the inverter is based on the factory carrier frequency, so if it is above the factory value, the inverter needs to derate 20% for every additional 1 kHz carrier frequency.

B.3 Grid specifications

<p>Grid voltage</p>	<p>AC 3PH 380V(-15%)~440V(+10%) AC 3PH 380V(-10%)~550V(+10%) AC 3PH 520V(-15%)~690V(+10%)</p>
<p>Short-circuit capacity</p>	<p>Maximum allowed prospective short-circuit current at the input power connection as defined in IEC 60439-1 is 100 kA. The drive is</p>

	suitable for use in a circuit capable of delivering not more than 100 kA at the drive maximum rated voltage.
Frequency	50/60 Hz \pm 5%, maximum rate of change 20%/s

B.4 Motor connection data

Motor type	Asynchronous induction motor or synchronous permanent magnet motor
Voltage	0 to U ₁ , 3-phase symmetrical, U _{max} at the field weakening point
Short-circuit protection	The motor output is short-circuit proof by IEC 61800-5-1
Frequency	0...400 Hz
Frequency resolution	0.01 Hz
Current	Refer to Ratings
Power limit	1.5 · PN
Field weakening point	10...400 Hz
Carrier frequency	4, 8, 12 or 15 kHz(in scalar control)

B.4.1 EMC compatibility and motor cable length

To comply with the European EMC Directive (standard IEC/EN 61800-3), use the following maximum motor cable lengths for 4 kHz switching frequency.

All frame sizes (with external EMC filter)	Maximum motor cable length, 4 kHz
Second environment (category C3)	30
First environment (category C2)	30

Maximum motor cable length is determined by the drive's operational factors. Contact the local representative for the exact maximum lengths when using external EMC filters.

B.5 Applicable standards

The inverter complies with the following standards:

EN ISO 13849-1: 2008	Safety of machinery-safety related parts of control systems - Part 1: general principles for design
IEC/EN 60204-1:2006	Safety of machinery. Electrical equipment of machines. Part 1: General requirements.
IEC/EN 62061: 2005	Safety of machinery – Functional safety of safety-related

	electrical, electronic and programmable electronic control systems
IEC/EN 61800-3:2004	Adjustable speed electrical power drive systems. Part 3: EMC requirements and specific test methods
IEC/EN 61800-5-1:2007	Adjustable speed electrical power drive systems – Part 5-1: Safety requirements – Electrical, thermal and energy
IEC/EN 61800-5-2:2007	Adjustable speed electrical power drive systems – Part 5-2: Safety requirements. Functional.

B.5.1 CE marking

The CE mark is attached to the drive to verify that the drive follows the provisions of the European Low Voltage and EMC Directives.

B.5.2 Compliance with the European EMC Directive

The EMC Directive defines the requirements for immunity and emissions of electrical equipment used within the European Union. The EMC product standard (EN 61800-3:2004) covers requirements stated for drives. See section *EMC regulations*

B.6 EMC regulations

EMC product standard (EN 61800-3:2004) contains the EMC requirements to the inverter.

First environment: domestic environment (includes establishments connected to a low-voltage network which supplies buildings used for domestic purposes).

Second environment includes establishments connected to a network not directly supplying domestic premises.

Four categories of the inverter:

Inverter of category C1: inverter of rated voltage less than 1000 V and used in the first environment.

Inverter of category C2: inverter of rated voltage less than 1000 V other than pins, sockets and motion devices and intended to be installed and commissioned only by a professional electrician when used in the first environment.

Note: IEC/EN 61800-3 in EMC standard doesn't limit the power distribution of the inverter, but it defines the usage, installation and commission. The professional electrician has necessary skills in installing and/or commissioning power drive systems, including their EMC aspects.

Inverter of category C3: inverter of rated voltage less than 1000 V and used in the second environment other than the first one

Inverter of category C4: inverter of rated voltage more than 1000 V or the nominal current is above or equal to 400A and used in the complicated system in second environment

B.6.1 Category C2

The emission limits are complied with the following provisions:

1. The optional EMC filter is selected according to the options and installed as specified in the EMC filter manual.
2. The motor and control cables are selected as specified in this manual.
3. The drive is installed according to the instructions given in this manual.
4. For the maximum motor cable length with 4 kHz switching frequency, see **EMC compatibility and motor cable length**



⇨ In a domestic environment, this product may cause radio interference, in which case supplementary mitigation measures may be required.

B.6.2 Category C3

The immunity performance of the drive complies with the demands of IEC/EN 61800-3, second environment.

The emission limits are complied with the following provisions:

1. The optional EMC filter is selected according to the options and installed as specified in the EMC filter manual.
2. The motor and control cables are selected as specified in this manual.
3. The drive is installed according to the instructions given in this manual.
4. For the maximum motor cable length with 4 kHz switching frequency, see **EMC compatibility and motor cable length**



⇨ A drive of category C3 is not intended to be used on a low-voltage public network which supplies domestic premises. Radio frequency interference is expected if the drive is used on such a network.

Dimension drawings

Appendix C

C.1 What this chapter contains

Dimension drawings of the Goodrive35 are shown below. The dimensions are given in millimeters and inches.

C.2 Keypad structure

C.2.1 Structure chart

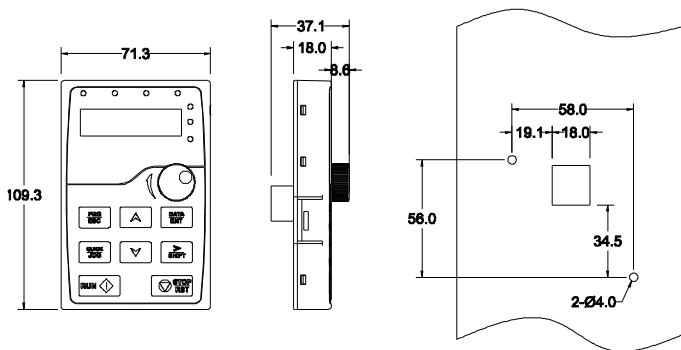

C.2.2 Installation bracket(optional)

Note: It is necessary to use M3 screw or installation bracket to fix the external keypad. The installation bracket for inverters of 380V 1.5~30kW is optional but it is standard for the inverters of 380V 37~500kW and 660V.

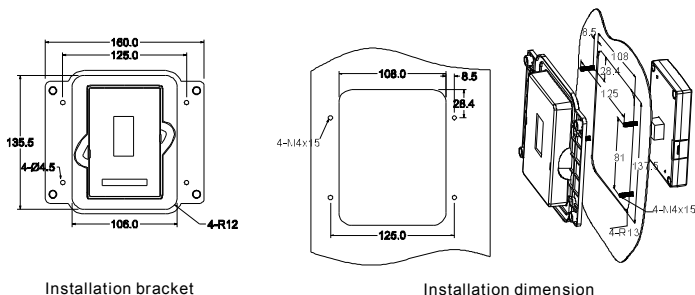

Installation bracket

Installation dimension

C.3 Inverter structure

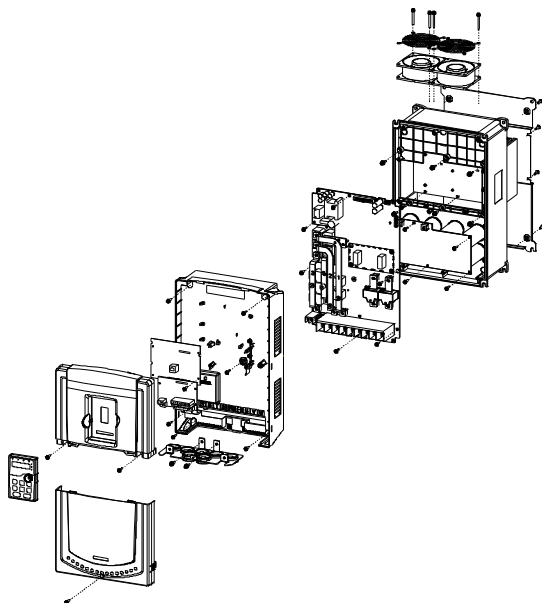

C.4 Dimensions for inverters of AC 3PH 380V(-15%)~440V(+10%)

C.4.1 Wall installation

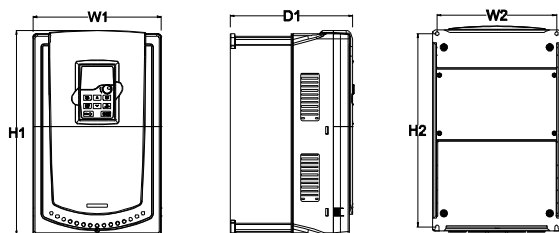

Wall installation of 380V 1.5-30kW inverters

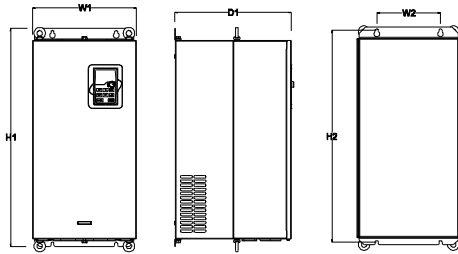

Wall installation of 380V 37-110kW inverters

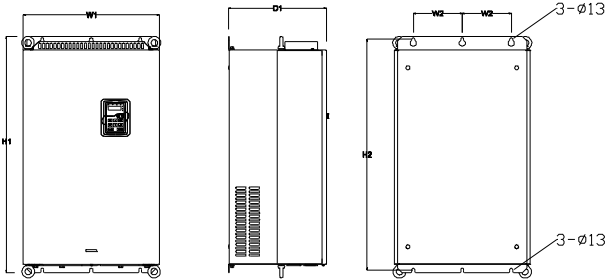

Wall installation of 380V 132-200kW inverters

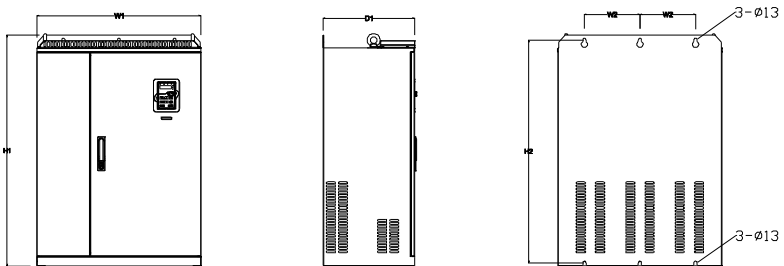

Wall installation of 380V 220-315kW inverters

Installation dimension (unit:mm)

Model	W1	W2	H1	H2	D1	Installation hole
1.5kW~2.2kW	126	115	193	175	174.5	5
4kW~5.5kW	146	131	263	243.5	181	6
7.5kW~11kW	170	151	331.5	303.5	216	6
15kW~18.5kW	230	210	342	311	216	6

Model	W1	W2	H1	H2	D1	Installation hole
22kW~30kW	255	237	407	384	245	7
37kW~55kW	270	130	555	540	325	7
75kW~110kW	325	200	680	661	365	9.5
132kW~200kW	500	180	870	850	360	11
220kW~315kW	680	230	960	926	380	13

C.4.2 Flange installation

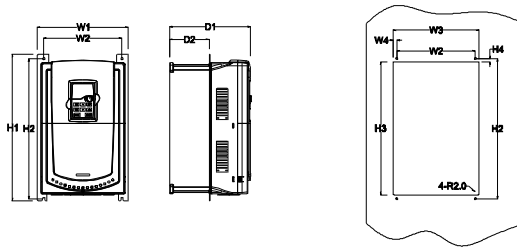

Flange installation of 380V 1.5-30kW inverters

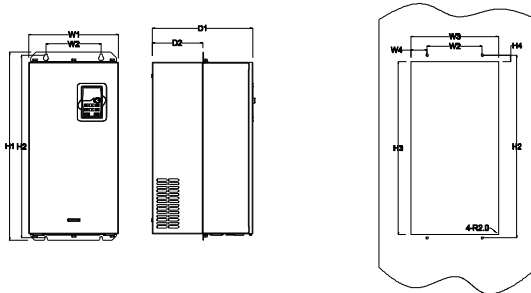

Flange installation of 380V 37-110kW inverters

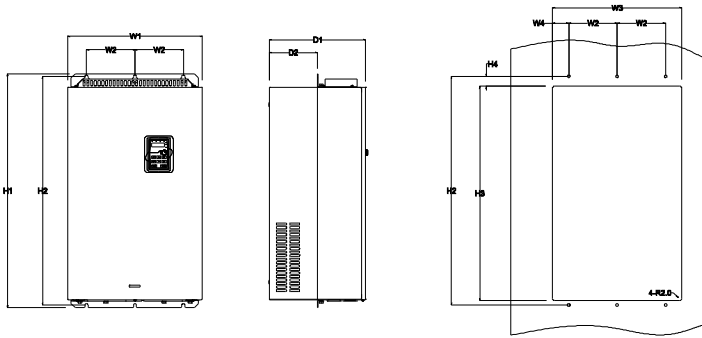

Flange installation of 380V 132-200kW inverters

Installation dimension (unit:mm)

Model	W1	W2	W3	W4	H1	H2	H3	H4	D1	D2	Installation hole
1.5kW~2.2kW	150	115	130	7.5	234	220	190	16.5	174.5	65.5	5
4kW~5.5kW	170	131	150	9.5	292	276	260	10	181	79.5	6
7.5kW~11kW	191	151	174	11.5	370	351	324	15	216.2	113	6
15kW~18.5kW	250	210	234	12	375	356	334	10	216	108	6
22kW~30kW	275	237	259	11	445	426	404	10	245	119	7
37kW~55kW	270	130	261	65.5	555	540	516	17	325	167	7
75kW~110kW	325	200	317	58.5	680	661	626	23	363	182	9.5
132kW~200kW	500	180	480	60	870	850	796	37	358	178.5	11

C.4.3 Floor installation

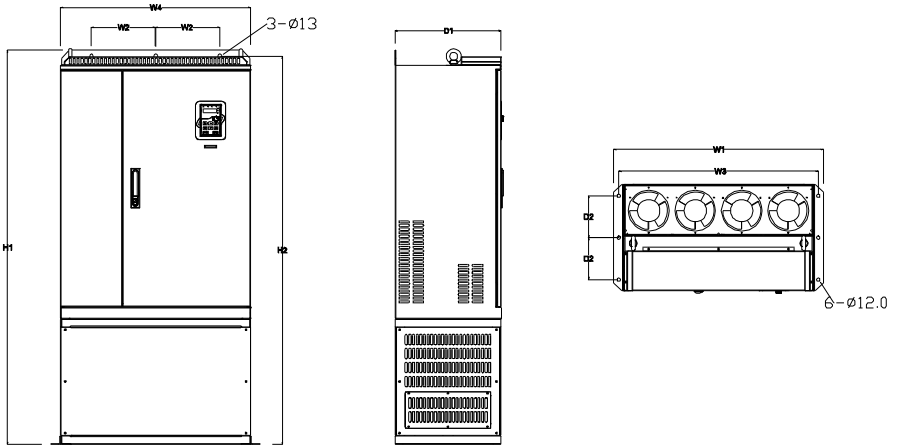

Floor installation of 380V 220-315kW inverters

Model	W1	W2	W3	W4	H1	H2	D1	D2	Installation hole
220kW~315kW	750	230	714	680	1410	1390	380	150	13\12

C.5 Dimensions for inverters of AC 3PH 520V(-15%)~690V(+10%)

C.5.1 Wall installation

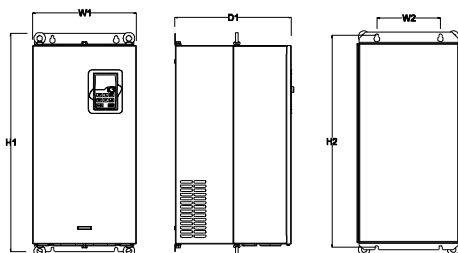

Wall installation of 660V 22-132kW inverters

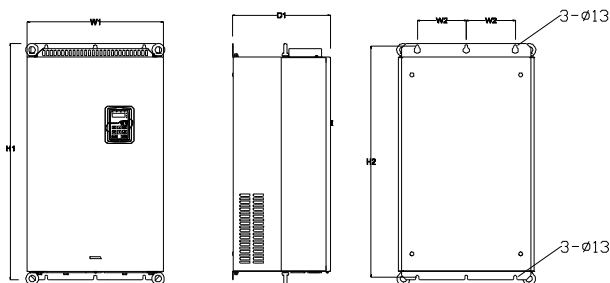

Wall installation of 660V 160-220kW inverters

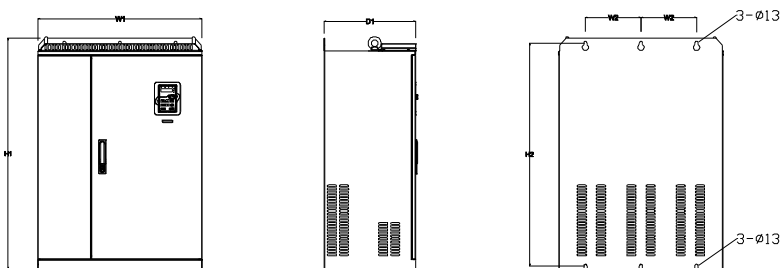

Wall installation of 660V 250-350kW inverters

Installation dimension (unit: mm)

Model	W1	W2	H1	H2	D1	Installation hole
22kW~45kW	270	130	555	540	325	7
55kW~132kW	325	200	680	661	365	9.5

Model	W1	W2	H1	H2	D1	Installation hole
160kW~220kW	500	180	870	850	360	11
250kW~350kW	680	230	960	926	380	13

C.5.2 Flange installation

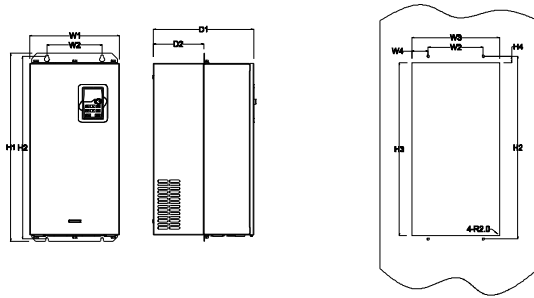

Flange installation of 660V 22-132kW inverters

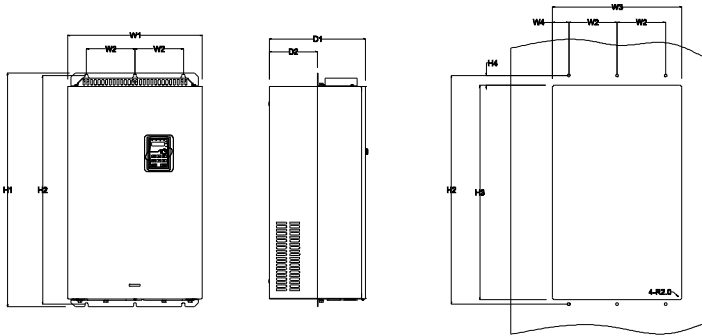

Flange installation of 660V 160-220kW inverters

Model	W1	W2	W3	W4	H1	H2	H3	H4	D1	D2	Installation hole
22kW~45kW	270	130	261	65.5	555	540	516	17	325	167	7
55kW~132kW	325	200	317	58.5	680	661	626	23	363	182	9.5
160kW~220kW	500	180	480	60	870	850	796	37	358	178.5	11

C.5.3 Floor installation

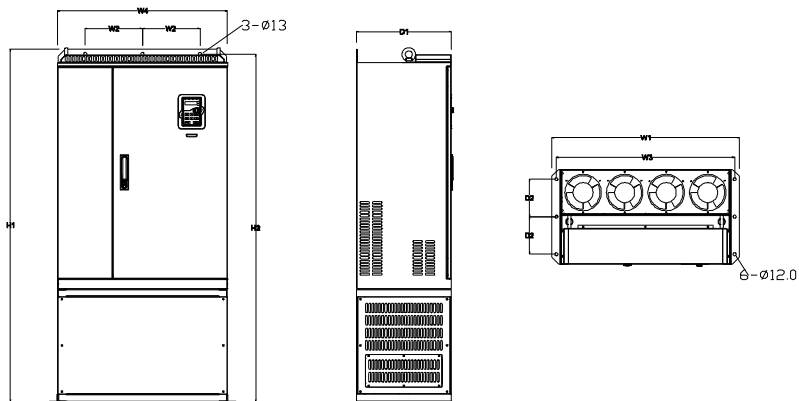

Floor installation of 660V 250-350kW inverters

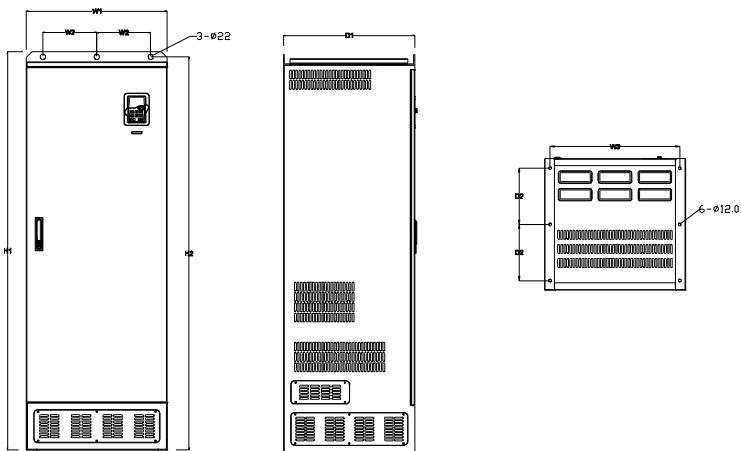

Floor installation of 660V 400-630kW inverters

Model	W1	W2	W3	W4	H1	H2	D1	D2	Installation hole
250kW~350kW	750	230	714	680	1410	1390	380	150	13\12
400kW~630kW	620	230	573	\	1700	1678	560	240	22\12

Peripheral options and parts

Appendix D

D.1 What this chapter contains

This chapter describes how to select the options and parts of Goodrive35 series.





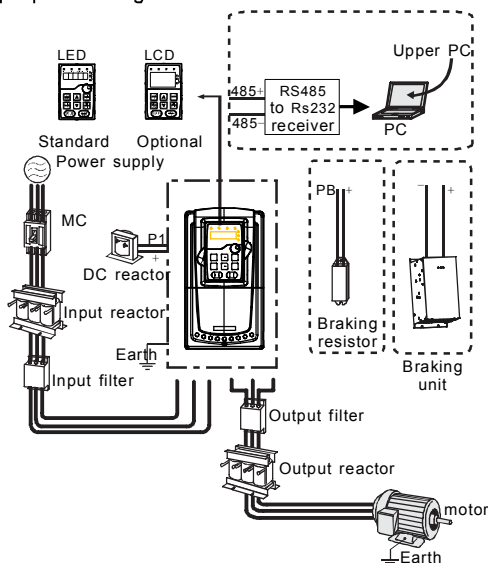

D.2 Peripheral wiring

Below is the peripheral wiring of Goodrive35 series inverters.

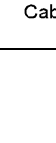

Note:

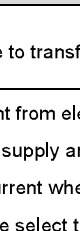
1. The inverter of 380V ($\leq 30\text{kW}$) are embedded with braking unit.
2. The inverters of 380V ($\geq 37\text{kW}$) and of 660V have P1 terminal and are connected with external DC reactors.
3. The braking units apply standard braking units. Refer to the instruction of DBU for detailed information.

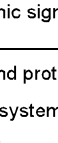
Pictures	Name	Descriptions
	Cables	Device to transfer the electronic signals
	Breaker	Prevent from electric shock and protect the power supply and the cables system from overcurrent when short circuits occur. (Please select the breaker with the function of reducing high order harmonic and the rated sensitive current to 1 inverter should be above 30mA).
	Input reactor	This device is used to improve the power factor of the input side of the inverter and control the higher harmonic current. The inverters of 380V ($\geq 37kW$) and of 660V have external DC reactors.
	DC reactor	
	Input filter	Control the electromagnetic interference generated from the inverter, please install close to the input terminal side of the inverter.
	Braking unit or resistors	Shorten the DEC time The inverter of 380V ($\leq 30kW$) need braking resistors and the inverters. The inverters of 380V ($\geq 37kW$) and of 660V need braking units.
	Output filter	Control the interference from the output side of the inverter and please install close to the output terminals of the inverter.
	Output reactor	Prolong the effective transmitting distance of the inverter to control the sudden high voltage when switching on/off the IGBT of the inverter.

D.3 Power supply

Please refer to *Electrical Installation*.



⚡ Check that the voltage degree of the inverter complies with the voltage of the supply power voltage.

D.4 Cables

D.4.1 Power cables

Dimension the input power and motor cables according to local regulations.

- The input power and the motor cables must be able to carry the corresponding load currents.
- The cable must be rated for at least 70 °C maximum permissible temperature of the conductor in continuous use.
- The conductivity of the PE conductor must be equal to that of the phase conductor (same cross-sectional area).
- Refer to chapter **Technical Data** for the EMC requirements.

A symmetrical shielded motor cable (see the figure below) must be used to meet the EMC requirements of the CE.

A four-conductor system is allowed for input cabling, but a shielded symmetrical cable is recommended. Compared to a four-conductor system, the use of a symmetrical shielded cable reduces electromagnetic emission of the whole drive system as well as motor bearing currents and wear.

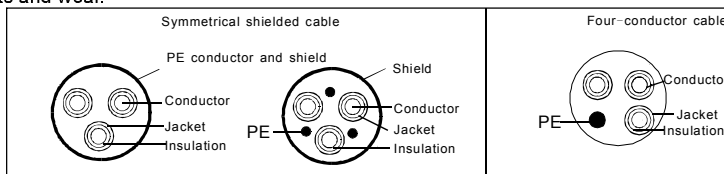

Note: A separate PE conductor is required if the conductivity of the cable shield is not sufficient for the purpose.

To function as a protective conductor, the shield must have the same cross-sectional area as the phase conductors when they are made of the same metal.

To effectively suppress radiated and conducted radio-frequency emissions, the shield conductivity must be at least 1/10 of the phase conductor conductivity. The requirements are easily met with a copper or aluminum shield. The minimum requirement of the motor cable shield of the drive is shown below. It consists of a concentric layer of copper wires. The better and tighter the shield, the lower the emission level and bearing currents.

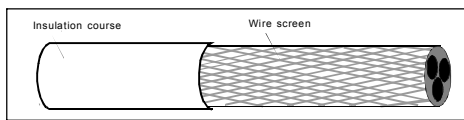

Cross section of the cable

D.4.2 Control cables

All analog control cables and the cable used for the frequency input must be shielded. Use a double-shielded twisted pair cable (Figure a) for analog signals. Employ one individually shielded pair for each signal. Do not use common return for different analog signals.

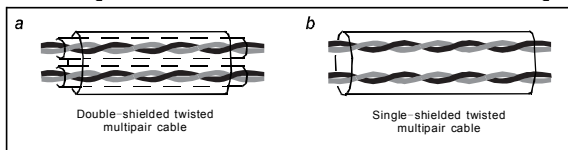

Configuration of the power cable

A double-shielded cable is the best alternative for low-voltage digital signals, but a single-shielded or unshielded twisted multipair cable (Fig b) is also usable. However, for frequency input, always use a shielded cable.

Note: Run analog and digital signals in separate cables.

The relay cable needs the cable type with braided metallic screen.

The keypad needs to connect with cables. It is recommended to use the screen cable on complex electrical magnetic condition.

Do not make any voltage tolerance or insulation resistance tests (for example hi-pot or megger) on any part of the drive as testing can damage the drive. Every drive has been tested for insulation between the main circuit and the chassis at the factory. Also, there are voltage-limiting circuits inside the drive which cut down the testing voltage automatically.

Check the insulation of the input power cable according to local regulations before connecting to the drive.

D.4.2.1 The inverters of AC 3PH 380V(-15%)~440V(+10%)

Model	Recommended cable size (mm ²)		Connecting cable size (mm ²)				Terminal screw	Tightening torque (Nm)
	RST UVW	PE	RST UVW	P1,(+)	PB (+),(-)	PE		
GD35-1R5G-4-C1/D1/H1	2.5	2.5	2.5~6	2.5~6	2.5~6	2.5~6	M4	1.2~1.5
GD35-2R2G-4-C1/D1/H1	2.5	2.5	2.5~6	2.5~6	2.5~6	2.5~6	M4	1.2~1.5

Model	Recommended cable size (mm ²)		Connecting cable size (mm ²)				Terminal screw	Tightening torque (Nm)
	RST UVW	PE	RST UVW	P1,(+)	PB (+),(-)	PE		
GD35-004G-4-A1/B1/C1/D1/H1	2.5	2.5	2.5~6	2.5~6	2.5~6	2.5~6	M4	1.2~1.5
GD35-5R5G-4-A1/B1/C1/D1/H1	2.5	2.5	2.5~6	4~6	4~6	2.5~6	M4	1.2~1.5
GD35-7R5G-4-A1/B1/C1/D1/H1	4	4	4~16	4~16	4~16	4~16	M5	2~2.5
GD35-011G-4-A1/B1/C1/D1/H1	6	6	6~16	6~16	6~16	6~16	M5	2~2.5
GD35-015G-4-A1/B1/C1/D1/H1	10	10	10~25	10~25	10~25	6~25	M5	2~2.5
GD35-018G-4-C1/D1/H1	16	16	16~25	16~25	16~25	10~25	M5	2~2.5
GD35-022G-4-C1/D1/H1	16	16	16~25	16~25	16~25	10~25	M6	4~6
GD35-030G-4-C1/D1/H1	25	16	16~25	16~25	16~25	16~25	M6	4~6
GD35-037G-4-C1/D1/H1	25	16	25~50	25~50	25~50	16~50	M8	9~11
GD35-045G-4-C1/D1/H1	35	16	25~50	25~50	25~50	16~50	M8	9~11
GD35-055G-4-C1/D1/H1	50	25	50~95	50~95	50~95	25~50	M8	9~11
GD35-075G-4-C1/D1/H1	70	35	70~95	70~95	70~95	35~50	M10	18~23
GD35-090G-4-C1/D1/H1	95	50	95~150	95~150	95~150	50~150	M10	18~23
GD35-110G-4-C1/D1/H1	120	70	95~300	95~300	95~300	70~240	M10	18~23
GD35-132G-4-C1/D1/H1	185	95	95~300	95~300	95~300	95~240	It is recommended to use wrench or sleeve because screw is used as terminal.	
GD35-160G-4-C1/D1/H1	240	120	95~300	95~300	95~300	120~240		
GD35-200G-4-C1/D1/H1	95*2P	120	95*2P ~150*2P	95*2P ~150*2P	95*2P ~150*2P	120~240		
GD35-220G-4-C1/D1/H1	150*2P	150	95*2P ~150*2P	95*2P ~150*2P	95*2P ~150*2P	150~240		
GD35-250G-4-C1/D1/H1	95*4P	95*2P	95*4P ~150*4P	95*4P ~150*4P	95*4P ~150*4P	95*2P ~150*2P		
GD35-280G-4-C1/D1/H1	95*4P	95*2P	95*4P ~150*4P	95*4P ~150*4P	95*4P ~150*4P	95*2P ~150*2P		
GD35-315G-4-C1/D1/H1	95*4P	95*4P	95*4P ~150*4P	95*4P ~150*4P	95*4P ~150*4P	95*2P ~150*2P		

Note:

1. It is appropriate to use the recommended cable size under 40°C and rated current. The wiring distance should be no more than 100m..
2. Terminals P1, (+), PB and (-) connects the DC reactor options and parts.

D.4.2.2 The inverters of AC 3PH 520V(-15%)~690V(+10%)

Model	Recommended cable size (mm ²)		Connecting cable size (mm ²)				Terminal screw	Tightening torque (Nm)
	RST UVW	PE	RST UVW	P1,(+)	PB (+),(-)	PE		
GD35-022G-6-C1/D1/H1	10	10	10~16	6~16	6~10	10~16	M8	9~11
GD35-030G-6-C1/D1/H1	10	10	10~16	6~16	6~10	10~16	M8	9~11
GD35-037G-6-C1/D1/H1	16	16	16~25	16~25	6~10	16~25	M8	9~11
GD35-045G-6-C1/D1/H1	16	16	16~25	16~35	16~25	16~25	M8	9~11
GD35-055G-6-C1/D1/H1	25	16	16~25	16~35	16~25	16~25	M10	18~23
GD35-075G-6-C1/D1/H1	35	16	35~50	25~50	25~50	16~50	M10	18~23
GD35-090G-6-C1/D1/H1	35	16	35~50	25~50	25~50	16~50	M10	18~23
GD35-110G-6-C1/D1/H1	50	25	50~95	50~95	25~95	25~95	M10	18~23
GD35-132G-6-C1/D1/H1	70	35	70~95	70~95	25~95	35~95	M10	18~23
GD35-160G-6-C1/D1/H1	95	50	95~150	95~150	25~150	50~150	It is recommended to use wrench or sleeve because screw is used as terminal.	
GD35-185G-6-C1/D1/H1	95	50	95~150	95~150	25~150	50~150		
GD35-200G-6-C1/D1/H1	120	70	120~300	120~300	35~300	70~240		
GD35-220G-6-C1/D1/H1	185	95	120~300	120~300	35~300	95~240		
GD35-250G-6-C1/D1/H1	185	95	185~300	185~300	35~300	95~240		
GD35-280G-6-C1/D1/H1	240	120	240~300	240~300	70~300	120~240		
GD35-315G-6-C1/D1/H1	95*2P	120	95*2P ~150*2P	95*2P ~150*2P	95*2P ~150*2P	120~300		
GD35-350G-6-C1/D1/H1	95*2P	150	95*2P ~150*2P	95*2P ~150*2P	95*2P ~150*2P	150~300		
GD35-400G-6-C1/D1/H1	150*2P	150	150*2P ~300*2P	95*2P ~150*2P	95*2P ~150*2P	150~300		
GD35-500G-6-C1/D1/H1	95*4P	95*2P	95*4P ~150*4P	95*4P ~150*4P	95*4P ~150*4P	95*2P ~150*2P		

Model	Recommended cable size (mm ²)		Connecting cable size (mm ²)				Terminal screw	Tightening torque (Nm)
	RST UVW	PE	RST UVW	P1,(+)	PB (+),(-)	PE		
GD35-560G-6-C1/D1/H1	95*4P	95*4P	95*4P ~150*4P	95*4P ~150*4P	95*4P ~150*4P	95*4P ~150*4P		
GD35-630G-6-C1/D1/H1	150*4P	150*2P	150*4P ~300*4P	150*4P ~300*4P	150*4P ~300*4P	150*4P ~240*4P		

Note:

1. It is appropriate to use the recommended cable size under 40°C and rated current. The wiring distance should be no more than 100m..
2. Terminals P1, (+), PB and (-) connects the DC reactor options and parts.

D.4.3 Routing the cables

Route the motor cable away from other cable routes. Motor cables of several drives can be run in parallel installed next to each other. It is recommended that the motor cable, input power cable and control cables are installed on separate trays. Avoid long parallel runs of motor cables with other cables to decrease electromagnetic interference caused by the rapid changes in the drive output voltage.

Where control cables must cross power cables make sure that they are arranged at an angle as near to 90 degrees as possible.

The cable trays must have good electrical bonding to each other and to the grounding electrodes. Aluminum tray systems can be used to improve local equalizing of potential.

A figure of the cable routing is shown below.

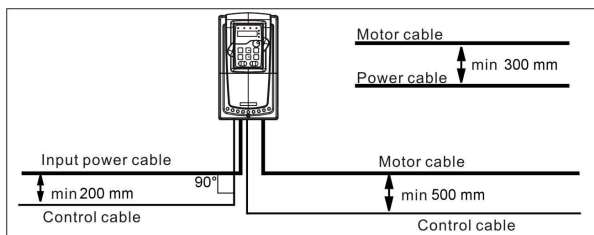

D.4.4 Insulation checking

Check the insulation of the motor and motor cable as follows:

1. Check that the motor cable is connected to the motor and disconnected from the drive output terminals U, V and W.
2. Measure the insulation resistance between each phase conductor and the Protective Earth conductor using a measuring voltage of 500 V DC. For the insulation resistance of other motors, please consult the manufacturer's instructions.

Note: Moisture inside the motor casing will reduce the insulation resistance. If moisture is suspected, dry the motor and repeat the measurement.

D.5 Breaker and electromagnetic contactor

It is necessary to add fuse for the avoidance of overload.

It is appropriate to use a breaker (MCCB) which complies with the inverter power in the 3-phase AC power and input power and terminals (R, S, T). The capacity of the inverter should be 1.5-2 times of the rated current.

	<p>⚡ Due to the inherent operating principle and construction of circuit breakers, independent of the manufacturer, hot ionized gases may escape from the breaker enclosure in case of a short-circuit. To ensure safe use, special attention must be paid to the installation and placement of the breakers. Follow the manufacturer's instructions.</p>
---	---

It is necessary to install the electromagnetic contactor in the input side to control the switching on and off safety of the main circuit. It can switch off the input power supply when system faults.

D.5.1 The inverters of AC 3PH 380V(-15%)~440V(+10%)

Model	Breaker (A)	Breaker (A)	The rated working current of the contactor(A)
GD35-1R5G-4-C1/D1/H1	15	16	10
GD35-2R2G-4-C1/D1/H1	17.4	16	10
GD35-004G-4-A1/B1/C1/D1/H1	30	25	16
GD35-5R5G-4-A1/B1/C1/D1/H1	45	25	16
GD35-7R5G-4-A1/B1/C1/D1/H1	60	40	25
GD35-011G-4-A1/B1/C1/D1/H1	78	63	32
GD35-015G-4-A1/B1/C1/D1/H1	105	63	50
GD35-018G-4- C1/D1/H1	114	100	63
GD35-022G-4- C1/D1/H1	138	100	80

Model	Breaker (A)	Breaker (A)	The rated working current of the contactor(A)
GD35-030G-4-C1/D1/H1	186	125	95
GD35-037G-4-C1/D1/H1	228	160	120
GD35-045G-4-C1/D1/H1	270	200	135
GD35-055G-4-C1/D1/H1	315	200	170
GD35-075G-4-C1/D1/H1	420	250	230
GD35-090G-4-C1/D1/H1	480	315	280
GD35-110G-4-C1/D1/H1	630	400	315
GD35-132G-4-C1/D1/H1	720	400	380
GD35-160G-4-C1/D1/H1	870	630	450
GD35-200G-4-C1/D1/H1	1110	630	580
GD35-220G-4-C1/D1/H1	1230	800	630
GD35-250G-4-C1/D1/H1	1380	800	700
GD35-280G-4-C1/D1/H1	1500	1000	780
GD35-315G-4-C1/D1/H1	1740	1200	900

Note: the specifications can be adjusted according to the actual working, but it can not be less than the designated values.

D.5.2 The inverters of AC 3PH 520V(-15%)~690V(+10%)

Model	Breaker (A)	Breaker (A)	The rated working current of the contactor(A)
GD35-022G-6-C1/D1/H1	105	63	50
GD35-030G-6-C1/D1/H1	105	63	50
GD35-037G-6-C1/D1/H1	114	100	63
GD35-045G-6-C1/D1/H1	138	100	80
GD35-055G-6-C1/D1/H1	186	125	95
GD35-075G-6-C1/D1/H1	270	200	135
GD35-090G-6-C1/D1/H1	270	200	135
GD35-110G-6-C1/D1/H1	315	200	170
GD35-132G-6-C1/D1/H1	420	250	230
GD35-160G-6-C1/D1/H1	480	315	280

Model	Breaker (A)	Breaker (A)	The rated working current of the contactor(A)
GD35-185G-6-C1/D1/H1	480	315	280
GD35-200G-6-C1/D1/H1	630	400	315
GD35-220G-6-C1/D1/H1	720	400	380
GD35-250G-6-C1/D1/H1	720	400	380
GD35-280G-6-C1/D1/H1	870	630	450
GD35-315G-6-C1/D1/H1	1110	630	580
GD35-350G-6-C1/D1/H1	1110	630	580
GD35-400G-6-C1/D1/H1	1230	800	630
GD35-500G-6-C1/D1/H1	1500	1000	780
GD35-560G-6-C1/D1/H1	1740	1200	900
GD35-630G-6-C1/D1/H1	2010	1380	1035

Note: the specifications can be adjusted according to the actual working, but it can not be less than the designated values.

D.6 Reactors

High current in the input power circuit may cause damage to the rectifying components. It is appropriate to use AC reactor in the input side for the avoidance of high-voltage input of the power supply and improvement of the power factors.

If the distance between the inverter and the motor is longer than 50m, frequent overcurrent protection may occur to the inverter because of high leakage current caused by parasitic capacitance effects from the long cables to the ground. In order to avoid the damage of the motor insulation, it is necessary to add reactor compensation.

The inverters of 380V ($\geq 37\text{Kw}$) and of 660V are equipped with internal DC reactors for the improvement of power factors and the avoidance of damage from high input current to the rectifying components because of the high-capacity transformer. The device can also cease the damage to the rectifying components which are caused by supply net voltage transients and harmonic waves of the loads.

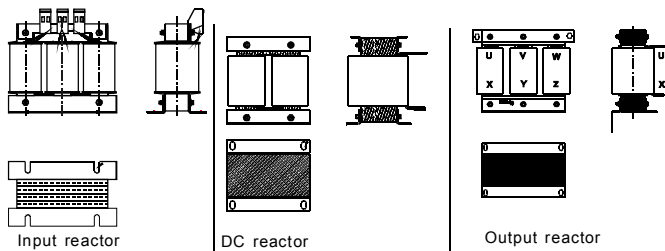

D.6.1 AC 3PH 380V(-15%)~440V(+10%)

Model	Input reactor	DC reactor	Output reactor
GD35-1R5G-4-C1/D1/H1	ACL2-1R5-4	/	OCL2-1R5-4
GD35-2R2G-4-C1/D1/H1	ACL2-2R2-4	/	OCL2-2R2-4
GD35-004G-4-A1/B1/C1/D1/H1	ACL2-004-4	/	OCL2-004-4
GD35-5R5G-4-A1/B1/C1/D1/H1	ACL2-5R5-4	/	OCL2-5R5-4
GD35-7R5G-4-A1/B1/C1/D1/H1	ACL2-7R5-4	/	OCL2-7R5-4
GD35-011G-4-A1/B1/C1/D1/H1	ACL2-011-4	/	OCL2-011-4
GD35-015G-4-A1/B1/C1/D1/H1	ACL2-015-4	/	OCL2-015-4
GD35-018G-4- C1/D1/H1	ACL2-018-4	/	OCL2-018-4
GD35-022G-4- C1/D1/H1	ACL2-022-4	/	OCL2-022-4
GD35-030G-4-C1/D1/H1	ACL2-030-4	/	OCL2-030-4
GD35-037G-4-C1/D1/H1	ACL2-037-4	DCL2-037-4	OCL2-037-4
GD35-045G-4-C1/D1/H1	ACL2-045-4	DCL2-045-4	OCL2-045-4
GD35-055G-4-C1/D1/H1	ACL2-055-4	DCL2-055-4	OCL2-055-4
GD35-075G-4-C1/D1/H1	ACL2-075-4	DCL2-075-4	OCL2-075-4
GD35-090G-4-C1/D1/H1	ACL2-090-4	DCL2-090-4	OCL2-090-4
GD35-110G-4-C1/D1/H1	ACL2-110-4	DCL2-110-4	OCL2-110-4
GD35-132G-4-C1/D1/H1	ACL2-132-4	DCL2-132-4	OCL2-132-4
GD35-160G-4-C1/D1/H1	ACL2-160-4	DCL2-160-4	OCL2-160-4
GD35-200G-4-C1/D1/H1	ACL2-200-4	DCL2-200-4	OCL2-200-4
GD35-220G-4-C1/D1/H1	ACL2-250-4	DCL2-250-4	OCL2-250-4
GD35-250G-4-C1/D1/H1	ACL2-250-4	DCL2-250-4	OCL2-250-4
GD35-280G-4-C1/D1/H1	ACL2-280-4	DCL2-280-4	OCL2-280-4
GD35-315G-4-C1/D1/H1	ACL2-315-4	DCL2-315-4	OCL2-315-4

Note:

1. The rated derate voltage of the input reactor is $2\% \pm 15\%$.
2. The power factor of the input side is above 90% after installing DC reactor.
3. The rated derate voltage of the output reactor is $1\% \pm 15\%$.
4. Above options are external, the customer should indicate when purchasing.

D.6.2 AC 3PH 520V(-15%)~690V(+10%)

Model	Input reactor	DC reactor	Output reactor
GD35-022G-6-C1/D1/H1	ACL2-022G-6	DCL2-022G-6	OCL2-022G-6
GD35-030G-6-C1/D1/H1	ACL2-030G-6	DCL2-030G-6	OCL2-030G-6
GD35-037G-6-C1/D1/H1	ACL2-037G-6	DCL2-037G-6	OCL2-037G-6
GD35-045G-6-C1/D1/H1	ACL2-045G-6	DCL2-045G-6	OCL2-045G-6
GD35-055G-6-C1/D1/H1	ACL2-055G-6	DCL2-055G-6	OCL2-055G-6
GD35-075G-6-C1/D1/H1	ACL2-075G-6	DCL2-075G-6	OCL2-075G-6
GD35-090G-6-C1/D1/H1	ACL2-090G-6	DCL2-090G-6	OCL2-090G-6
GD35-110G-6-C1/D1/H1	ACL2-110G-6	DCL2-110G-6	OCL2-110G-6
GD35-132G-6-C1/D1/H1	ACL2-132G-6	DCL2-132G-6	OCL2-132G-6
GD35-160G-6-C1/D1/H1	ACL2-160G-6	DCL2-160G-6	OCL2-160G-6
GD35-185G-6-C1/D1/H1	ACL2-185G-6	DCL2-185G-6	OCL2-185G-6
GD35-200G-6-C1/D1/H1	ACL2-200G-6	DCL2-200G-6	OCL2-200G-6
GD35-220G-6-C1/D1/H1	ACL2-220G-6	DCL2-220G-6	OCL2-220G-6
GD35-250G-6-C1/D1/H1	ACL2-250G-6	DCL2-250G-6	OCL2-250G-6
GD35-280G-6-C1/D1/H1	ACL2-280G-6	DCL2-280G-6	OCL2-280G-6
GD35-315G-6-C1/D1/H1	ACL2-315G-6	DCL2-315G-6	OCL2-315G-6
GD35-350G-6-C1/D1/H1	ACL2-350G-6	DCL2-350G-6	OCL2-350G-6
GD35-400G-6-C1/D1/H1	Standard	DCL2-400G-6	OCL2-400G-6
GD35-500G-6-C1/D1/H1	Standard	DCL2-500G-6	OCL2-500G-6
GD35-560G-6-C1/D1/H1	Standard	DCL2-560G-6	OCL2-560G-6
GD35-630G-6-C1/D1/H1	Standard	DCL2-630G-6	OCL2-630G-6

Note:

1. The rated derate voltage of the input reactor is $2\% \pm 15\%$.
2. The power factor of the input side is above 90% after installing DC reactor.
3. The rated derate voltage of the output reactor is $1\% \pm 15\%$.
4. Above options are external, the customer should indicate when purchasing.

Character designation	Detailed instruction
F	Utilization environment of the filters A:the first environment (IEC61800-3:2004) category C1 (EN 61800-3:2004) B:the first environment (IEC61800-3:2004) category C2 (EN 61800-3:2004) C:the second environment (IEC61800-3:2004) category C3 (EN 61800-3:2004)

D.7.2 AC 3PH 380V(-15%)~440V(+10%)

Model	Input filter	Output filter
GD35-1R5G-4-C1/D1/H1	FLT-P04006L-B	FLT-L04006L-B
GD35-2R2G-4-C1/D1/H1		
GD35-004G-4-A1/B1/C1/D1/H1	FLT-P04016L-B	FLT-L04016L-B
GD35-5R5G-4-A1/B1/C1/D1/H1		
GD35-7R5G-4-A1/B1/C1/D1/H1	FLT-P04032L-B	FLT-L04032L-B
GD35-011G-4-A1/B1/C1/D1/H1		
GD35-015G-4-A1/B1/C1/D1/H1	FLT-P04045L-B	FLT-L04045L-B
GD35-018G-4- C1/D1/H1		
GD35-022G-4- C1/D1/H1	FLT-P04065L-B	FLT-L04065L-B
GD35-030G-4-C1/D1/H1		
GD35-037G-4-C1/D1/H1	FLT-P04100L-B	FLT-L04100L-B
GD35-045G-4-C1/D1/H1		
GD35-055G-4-C1/D1/H1	FLT-P04150L-B	FLT-L04150L-B
GD35-075G-4-C1/D1/H1		
GD35-090G-4-C1/D1/H1	FLT-P04200L-B	FLT-L04200L-B
GD35-110G-4-C1/D1/H1		
GD35-132G-4-C1/D1/H1	FLT-P04250L-B	FLT-L04250L-B
GD35-160G-4-C1/D1/H1		
GD35-200G-4-C1/D1/H1	FLT-P04400L-B	FLT-L04400L-B
GD35-220G-4-C1/D1/H1		
GD35-250G-4-C1/D1/H1	FLT-P04600L-B	FLT-L04600L-B
GD35-280G-4-C1/D1/H1		
GD35-315G-4-C1/D1/H1	FLT-P04800L-B	FLT-L04800L-B

Note:

D.7 Filter

Goodrive35 series inverters have embedded C3 filters which can be connected by J10.

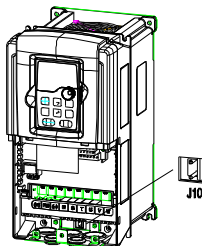

Note: Do not connect C3 filters in IT power system.

The input interference filter can decrease the interference of the inverter to the surrounding equipments.

Output interference filter can decrease the radio noise cause by the cables between the inverter and the motor and the leakage current of the conducting wires.

Our company configured some filters for the convenient of the users.

D.7.1 Filter type instruction

A
B
C
D
E
F

Character designation	Detailed instruction
A	FLT:inverter filter series
B	Filter type P:power supply filter L:output filter
C	Voltage degree 04: AC 3PH 380V (-15%)~440V(+10%) 06: AC 3PH 520V (-15%)~690V(+10%)
D	3 bit rated current code "015" means 15A
E	Installation type L: Common type H: High performance type

1. The input EMI meet the requirement of C2 after installing input filters.
2. Above options are external, the customer should indicate when purchasing.

D.7.3 AC 3PH 520V(-15%)~690V(+10%)

Model	Input filter	Output filter
GD35-022G-6-C1/D1/H1	FLT-P06050H-B	FLT-L06050H-B
GD35-030G-6-C1/D1/H1		
GD35-037G-6-C1/D1/H1		
GD35-045G-6-C1/D1/H1	FLT-P06100H-B	FLT-L06100H-B
GD35-055G-6-C1/D1/H1		
GD35-075G-6-C1/D1/H1		
GD35-090G-6-C1/D1/H1		
GD35-110G-6-C1/D1/H1	FLT-P06200H-B	FLT-L06200H-B
GD35-132G-6-C1/D1/H1		
GD35-160G-6-C1/D1/H1		
GD35-185G-6-C1/D1/H1		
GD35-200G-6-C1/D1/H1	FLT-P06300H-B	FLT-L06300H-B
GD35-220G-6-C1/D1/H1		
GD35-250G-6-C1/D1/H1		
GD35-280G-6-C1/D1/H1		
GD35-315G-6-C1/D1/H1	FLT-P06400H-B	FLT-L06400H-B
GD35-350G-6-C1/D1/H1		
GD35-400G-6-C1/D1/H1	FLT-P061000H-B	FLT-L061000H-B
GD35-500G-6-C1/D1/H1		
GD35-560G-6-C1/D1/H1		
GD35-630G-6-C1/D1/H1		

Note:



1. The input EMI meet the requirement of C2 after adding input filters.
2. Above options are external, the customer should indicate when purchasing.

D.8 Braking system

D.8.1 Select the braking components

It is appropriate to use braking resistor or braking unit when the motor brakes sharply or the motor is driven by a high inertia load. The motor will become a generator if its actual rotating

speed is higher than the corresponding speed of the reference frequency. As a result, the inertial energy of the motor and load return to the inverter to charge the capacitors in the main DC circuit. When the voltage increases to the limit, damage may occur to the inverter. It is necessary to apply braking unit/resistor to avoid this accident happens.

	<ul style="list-style-type: none"> ◇ Only qualified electricians are allowed to design, install, commission and operate on the inverter. ◇ Follow the instructions in "warning" during working. Physical injury or death or serious property may occur. ◇ Only qualified electricians are allowed to wire. Damage to the inverter or braking options and part may occur. Read carefully the instructions of braking resistors or units before connecting them with the inverter. ◇ Do not connect the braking resistor with other terminals except for PB and (-). Do not connect the braking unit with other terminals except for (+) and (-). Damage to the inverter or braking circuit or fire may occur.
	<ul style="list-style-type: none"> ◇ Connect the braking resistor or braking unit with the inverter according to the diagram. Incorrect wiring may cause damage to the inverter or other devices.

Goodrive35 series inverters below 30kW (including 30kW) need internal braking units and the inverters above 37kW need external braking unit. Please select the resistance and power of the braking resistors according to actual utilization.

D.8.1.1 AC 3PH 380V(-15%)~440V(+10%)

The inverters of 380V (≤30kW) have embedded braking units but the inverters of 380V (≥37kW) have optional braking units. Please select the braking resistor according to actual operation.

Model	Model of braking unit	Braking Resistor at 100% of the braking torque(Ω)	The consumed power of the braking resistor			The consumed power of the braking resistor
			10% braking	50% braking	80% braking	
			GD35-1R5G-4-C1/D1/H1	Embedded	326	



Model	Model of braking unit	Braking Resistor at 100% of the braking torque(Ω)	The consumed power of the braking resistor			The consumed power of the braking resistor
			10% braking	50% braking	80% braking	
GD35-2R2G-4-C1/D1/H1	braking units	222	0.33	1.7	2.6	130
GD35-004G-4-A1/B1/C1/D1/H1		122	0.6	3	4.8	80
GD35-5R5G-4-A1/B1/C1/D1/H1		89	0.75	4.1	6.6	60
GD35-7R5G-4-A1/B1/C1/D1/H1		65	1.1	5.6	9	47
GD35-011G-4-A1/B1/C1/D1/H1		44	1.7	8.3	13.2	31
GD35-015G-4-A1/B1/C1/D1/H1		32	2	11	18	23
GD35-018G-4- C1/D1/H1		27	3	14	22	19
GD35-022G-4- C1/D1/H1		22	3	17	26	17
GD35-030G-4-C1/D1/H1		16	5	23	36	17
GD35-037G-4-C1/D1/H1	DBU100H-060-4	13	6	28	44	11.7
GD35-045G-4-C1/D1/H1	DBU100H-110-4	10	7	34	54	6.4
GD35-055G-4-C1/D1/H1		8	8	41	66	
GD35-075G-4-C1/D1/H1		6.5	11	56	90	
GD35-090G-4-C1/D1/H1	DBU100H-160-4	5.4	14	68	108	4.4
GD35-110G-4-C1/D1/H1		4.5	17	83	132	
GD35-132G-4-C1/D1/H1	DBU100H-220-4	3.7	20	99	158	3.2
GD35-160G-4-C1/D1/H1	DBU100H-320-4	3.1	24	120	192	2.2
GD35-200G-4-C1/D1/H1		2.5	30	150	240	
GD35-220G-4-C1/D1/H1	DBU100H-400-4	2.2	33	165	264	1.8
GD35-250G-4-C1/D1/H1		2.0	38	188	300	
GD35-280G-4-C1/D1/H1	Two	3.6*2	21*2	105*2	168*2	2.2*2
GD35-315G-4-C1/D1/H1	DBU100H-320-4	3.2*2	24*2	118*2	189*2	

Note:

Select the resistor and power of the braking unit according to the data our company provided.

The braking resistor may increase the braking torque of the inverter. The resistor power in the above table is designed on 100% braking torque and 10% braking usage ratio. If the users need more braking torque, the braking resistor can decrease properly and the power needs to be magnified.

When using the external braking units, please see the instructions of the energy braking units to set the voltage degree of the braking unit. Incorrect voltage degree may affect the normal running of the inverter.

	↪ Never use a brake resistor with a resistance below the minimum value specified for the particular drive. The drive and the internal chopper are not able to handle the overcurrent caused by the low resistance.
	↪ Increase the power of the braking resistor properly in the frequent braking situation (the frequency usage ratio is more than 10%).

D.8.2 AC 3PH 380V(-15%)~440V(+10%)

The inverters of 660V have optional braking units. Please select the braking resistor according to actual operation.

Model	Model of braking unit	Braking Resistor at 100% of the braking torque(Ω)	The consumed power of the braking resistor			The consumed power of the braking resistor
			10% braking	50% braking	80% braking	
GD35-022G-6-C1/D1/H1	DBU100H-110-6	55	4	17	27	10.0
GD35-030G-6-C1/D1/H1		40.3	5	23	36	
GD35-037G-6-C1/D1/H1		32.7	6	28	44	
GD35-045G-6-C1/D1/H1		26.9	7	34	54	
GD35-055G-6-C1/D1/H1		22.0	8	41	66	
GD35-075G-6-C1/D1/H1		16.1	11	56	90	
GD35-090G-6-C1/D1/H1		13.4	14	68	108	
GD35-110G-6-C1/D1/H1		11.0	17	83	132	
GD35-132G-6-C1/D1/H1	DBU100H-160-6	9.2	20	99	158	6.9
GD35-160G-6-C1/D1/H1		7.6	24	120	192	
GD35-185G-6-C1/D1/H1	DBU100H-220-6	6.5	28	139	222	5.0



Model	Model of braking unit	Braking Resistor at 100% of the braking torque(Ω)	The consumed power of the braking resistor			The consumed power of the braking resistor
			10% braking	50% braking	80% braking	
GD35-200G-6-C1/D1/H1		6.1	30	150	240	
GD35-220G-6-C1/D1/H1		5.5	33	165	264	
GD35-250G-6-C1/D1/H1	DBU100H-320-6	4.8	38	188	300	3.4
GD35-280G-6-C1/D1/H1		4.3	42	210	336	
GD35-315G-6-C1/D1/H1		3.8	47	236	378	
GD35-350G-6-C1/D1/H1		3.5	53	263	420	
GD35-400G-6-C1/D1/H1	DBU100H-400-6	3.0	60	300	480	2.8
GD35-500G-6-C1/D1/H1	Two DBU100H-320-6	4.8*2	38*2	188*2	300*2	3.4*2
GD35-560G-6-C1/D1/H1		4.3*2	42*2	210*2	336*2	
GD35-630G-6-C1/D1/H1		3.8*2	47*2	236*2	378*2	

Note:

Select the resistor and power of the braking unit according to the data our company provided.

The braking resistor may increase the braking torque of the inverter. The resistor power in the above table is designed on 100% braking torque and 10% braking usage ratio. If the users need more braking torque, the braking resistor can decrease properly and the power needs to be magnified.

When using the external braking units, please see the instructions of the energy braking units to set the voltage degree of the braking unit. Incorrect voltage degree may affect the normal running of the inverter.

	⚡ Never use a brake resistor with a resistance below the minimum value specified for the particular drive. The drive and the internal chopper are not able to handle the overcurrent caused by the low resistance.
	⚡ Increase the power of the braking resistor properly in the frequent braking situation (the frequency usage ratio is more than 10%).

D.8.3 Selecting the brake resistor cables

Use a shielded cable to the resistor cable.

D.8.4 Placing the brake resistor

Install all resistors in a place with enough ventilation.

	<p>↯ The materials near the brake resistor must be non-flammable. The surface temperature of the resistor is high. Air flowing from the resistor is of hundreds of degrees Celsius. Protect the resistor against contact.</p>
---	---

Installation of the braking resistor:

	<p>↯ The inverters of 380V ($\leq 30\text{kW}$) only need external braking resistors.</p> <p>↯ PB and (+) are the wiring terminals of the braking resistors.</p>
---	---

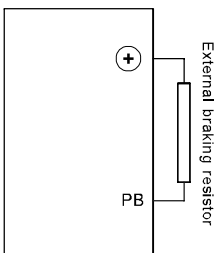

Installation of braking units:

	<p>↯ The inverters of 380V ($\geq 37\text{kW}$) need external braking units.</p> <p>↯ The inverters of 660V need external braking units.</p> <p>↯ (+), (-) are the wiring terminals of the braking units.</p> <p>↯ The wiring length between the (+),(-) terminals of the inverter and the (+),(-) terminals of the braking units should be no more than 5m, and the distributing length among BR1 and BR2 and the braking resistor terminals should be no more than 10m.</p>
--	--

Signal installation is as below:

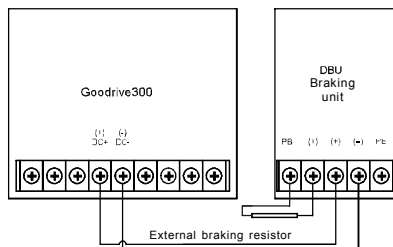

Further information

Appendix E

E.1.1 Product and service inquiry

Address any inquiries about the product to your local INVT offices, quoting the type designation and serial number of the unit in question. A listing of INVT sales, support and service contacts can be found on www.invt.com.cn.

E.1.2 Feedback on INVT Inverters manuals

Your comments on our manuals are welcome. Go to www.invt.com.cn and select *Online Feedback* or *Contact Us*.

E.1.3 Documents on the Internet

You can find manuals and other product documents in PDF format on the Internet. Go to www.invt.com.cn and select *Service and Support of Document Download*.



Service line:86-755-86312859 E-mail:overseas@invt.com.cn Website:www.invt.com

SHENZHEN INVT ELECTRIC CO., LTD. No. 4 Building, Gaofa Scientific Industrial Park, Longjing, Nanshan District, Shenzhen, China

Industrial Automation: ■ Frequency Inverter ■ Servo & Motion Control ■ Motor & Electric Spindle ■ PLC
■ HMI ■ Intelligent Elevator Control System ■ Traction Drive
Electric Power: ■ SVG ■ Solar Inverter ■ UPS ■ Online Energy Management System



66001-00097